

SUORITUSTASOILMOITUS

DoP Nro: MKT-2.5-300_fi

- ✧ **Tuotetyypin yksilöllinen tunniste:** Kemiallinen ankkuri VZ
- ✧ **Aiottu käyttötarkoitus (aiotut käyttötarkoitukset):** Liimattu ankkuri ankkuroitavaksi betonissa, katso liite / Annex B
- ✧ **Valmistaja:** MKT Metall-Kunststoff-Technik GmbH & Co.KG
Auf dem Immel 2
67685 Weilerbach
- ✧ **Rakennustuotteen suoritusasteen pysyvyyden arviointi- ja varmennusjärjestelmä(t):** 1
- ✧ **Eurooppalainen arviointiasiakirja:** EAD 330499-01-0601
Eurooppalainen tekninen arviointi: ETA-20/0533, 17.04.2021
Teknisestä arvioinnista vastaava laitos: DIBt, Berlin
Ilmoitettu laitos/ilmoitetut laitokset: NB 2873 – Technische Universität Darmstadt

✧ **Ilmoitettu suoritusaste/ilmoitetut suoritusasteet:**

Olennaiset ominaisuudet	Suoritusaste
Mekaaninen lujuus ja vakaus (BWR 1)	
Ominaisresistanssit vetolujuudessa (staattiset ja lähes staattiset vaikutukset)	Liite / Annex C1, C2, B2
Ominaisresistanssit poikittaisessa rasituksessa (staattiset ja lähes staattiset vaikutukset)	Liite / Annex C1, C3
Vuorossa (staattiset ja lähes staattiset vaikutukset)	Liite / Annex C4
Ominaisvastus ja siirtymät seismiselle suorituskykyluokalle C1 + C2	Suorituskykyä ei arvioitu
Hygienia, terveys ja ympäristö (BWR 3)	
Vaarallisten aineiden pitoisuus, päästöt ja / tai päästöt	Suorituskykyä ei arvioitu

Edellä yksilöidyn tuotteen suoritusaste on ilmoitettujen suoritusasteiden joukon mukainen. Tämä suoritusasteilmoitus on asetuksen (EU) N:o 305/2011 mukaisesti annettu edellä ilmoitetun valmistajan yksinomaisella vastuulla.

Valmistajan puolesta allekirjoittanut:

Stefan Weustenhagen
(Toimitusjohtaja)
Weilerbach, 17.04.2021

p.p. 
Dipl.-Ing. Detlef Bigalke
(Tuotekehityksen johtaja)



Tämän suoritusasteilmoituksen alkuperäinen teksti on kirjoitettu saksaksi. Jos käännökset poikkeavat toisistaan, saksankielinen versio on pätevä.

Specifications of intended use

Anchor size	M8	M10	M12	M16	M20
Static or quasi-static action	✓				
Base materials	compacted, reinforced or unreinforced normal weight concrete without fibers acc. to EN 206:2013+A1:2016				
	strength classes C20/25 to C50/60, acc. to EN 206:2013+A1:2016				
	cracked or uncracked concrete				
Temperature range I	-40°C to +40°C	max long term temperature +24°C; max short term temperature +40°C			
Temperature range II	-40°C to +80°C	max long term temperature +50°C; max short term temperature +80°C			

Use conditions (Environmental conditions):

- Structures subject to dry internal conditions: all versions
- For all other conditions corresponding to corrosion resistance classes CRC according to EN 1993-1-4:2015, Annex A, Table A.2:
 - V-A A2: CRC II
 - V-A A4: CRC III
 - V-A HCR: CRC V

Design:

- Verifiable calculation notes and drawings are prepared taking account of the loads to be anchored. The position of the anchor is indicated on the design drawings (e.g. position of the anchor relative to reinforcement or to supports, etc.)
- Anchorages are designed under the responsibility of an engineer experienced in anchorages and concrete work
- Anchorages are designed according to EN 1992-4:2018 or TR 055, version February 2018

Installation:

- Dry or wet concrete
- Making of drill hole by hammer drilling, compressed air drilling or vacuum drilling
- Installation direction: D3 - downwards, horizontally and upwards (e.g. overhead) installation

Intended use
Specifications

Annex B1

Table B1: Installation parameters

Anchor size			M8	M10	M12	M16	M20
Diameter of threaded rod	$d=d_{nom}$	[mm]	8	10	12	16	20
Nominal diameter of drill hole	d_0	[mm]	10	12	14	18	22
Depth of drill hole	h_0	[mm]	80	90	110	125	170
Effective anchorage depth	h_{ef}	[mm]	80	90	110	125	170
Diameter of clearance hole in the fixture	d_f	[mm]	9	12	14	18	22
Cleaning Brush		[-]	RB 10	RB 12	RB 14	RB 18	RB 22
Diameter of Cleaning Brush	$d_b \geq$	[mm]	10,5	12,5	14,5	18,5	22,5
Maximum installation torque	$max T_{inst}$	[Nm]	10	20	40	80	150

Supplies

Vacuum drill bit



Vacuum drill bit (MKT Hollow drill bit SB, Würth extraction drill bit or Heller Duster Expert) and a class M vacuum with minimum negative pressure of 253 hPa and a flow rate of minimum 42 l/s

Blow-out pump (volume 750ml)



Cleaning Brush RB



Table B2: Minimum member thickness, edge distance and spacing

Anchor size			M8	M10	M12	M16	M20
Minimum member thickness	h_{min}	[mm]	110	120	140	160	220
Minimum edge distance	c_{min}	[mm]	40	45	45	50	55
Minimum spacing	s_{min}	[mm]	40	50	60	75	90

Table B3: Curing time

Concrete temperature	Minimum curing time
-20°C to -16°C	17 h
-15°C to -11°C	7 h
-10°C to -6°C	4 h
-5°C to -1°C	3 h
0°C to +4°C	50 min
+5°C to +9°C	25 min
+10°C to +19°C	15 min
+20°C to +29°C	6 min
+30°C to +40°C	6 min
Capsule temperature	-15°C to +40°C

Capsule Adhesive Anchor VZ

Intended use

Installation parameters, edge distance and spacing, Curing time

Annex B2

Installation instructions

Drilling

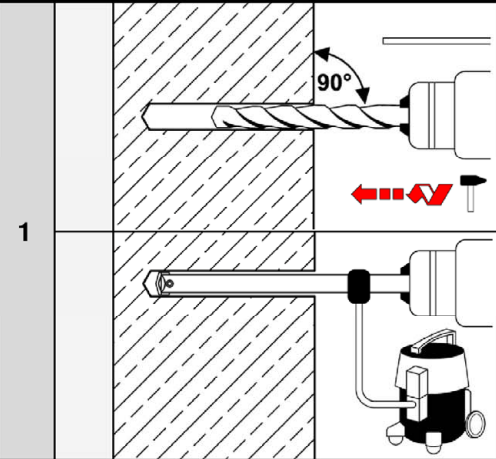

Hammer drill or compressed air drill:
 Drill the hole with diameter and depth according to Table B1. Continue with step 2.

Vacuum drill: see Annex B2
 Drill the hole with diameter and depth according to Table B1. Additional cleaning is not necessary - continue with step 3.

Cleaning

Drill hole must be cleaned directly before installation of the anchor, or it must be protected against recontamination in a suitable manner until installation of the anchor.

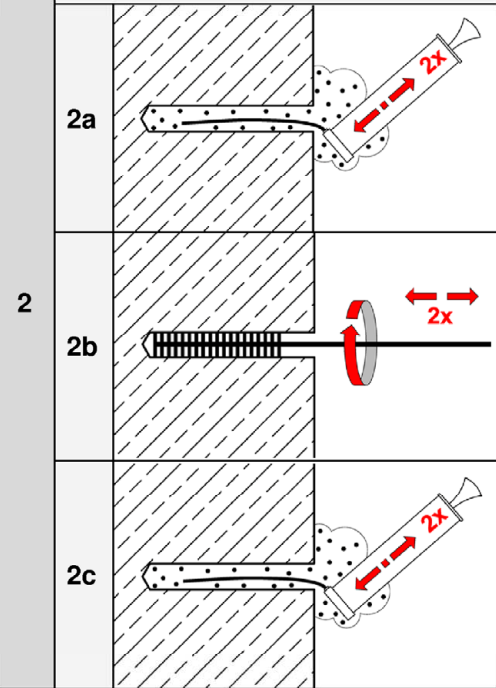

2a Blow out the drill hole completely at least **2x** from the bottom of the drill hole with blow-out pump or compressed air.

2b Brush the drill hole **2x** with Cleaning Brush RB (Table B1). Observe and check brush diameter $d_{b,min}$. When inserting the brush into the drill hole, a clear resistance must be noticeable. Otherwise use a new Cleaning Brush.

2c Blow out the drill hole completely at least **2x** from the bottom of the drill hole with blow-out pump or compressed air.

Capsule Adhesive Anchor VZ

Intended use
 Installation instructions

Annex B3

Installation instructions - continuation

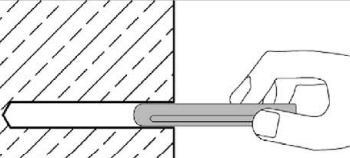
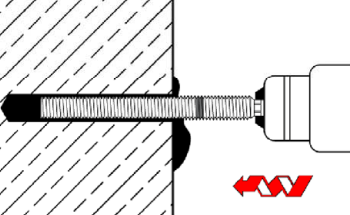
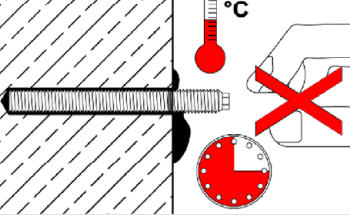
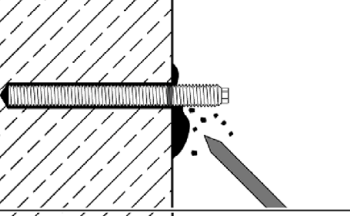
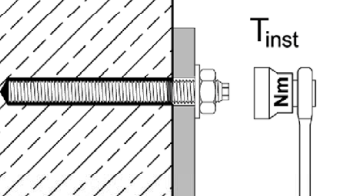
Inserting the threaded rod		
3		Insert the capsule into the drill hole.
4		Drive in the anchor rod using a hammer drill set on rotary impact. Stop immediately after reaching the setting depth.
5		Observe curing time according to Table B3. Do not move or load the anchor until it is fully cured.
6		Remove excess adhesive.
7		Install fixture and apply installation torque T_{inst} according to Table B1.

Capsule Adhesive Anchor VZ

Intended Use

Installation instructions - continuation

Annex B4

Table C1: Characteristic steel resistance under tension load

Anchor size				M8	M10	M12	M16	M20
Steel failure								
Characteristic resistance under tension load								
Steel, zinc plated	Property class 5.8	$N_{Rk,s}$	[kN]	18	29	42	79	123
	Property class 8.8	$N_{Rk,s}$	[kN]	29	46	67	126	196
Stainless steel / High corrosion resistant steel	Property class 70	$N_{Rk,s}$	[kN]	26	41	59	110	172
	Property class 80	$N_{Rk,s}$	[kN]	29	46	67	126	196
Partial factor ¹⁾								
Steel, zinc plated	Property class 5.8	$\gamma_{Ms,N}$	[-]	1,5				
	Property class 8.8	$\gamma_{Ms,N}$	[-]	1,5				
Stainless steel / High corrosion resistant steel	Property class 70	$\gamma_{Ms,N}$	[-]	1,87				
	Property class 80	$\gamma_{Ms,N}$	[-]	1,6				

¹⁾ In absence of other national regulations

Table C2: Characteristic steel resistance under shear load

Anchor size				M8	M10	M12	M16	M20
Characteristic resistances under shear load								
Steel failure <u>without</u> lever arm								
Steel, zinc plated	Property class 5.8	$V^0_{Rk,s}$	[kN]	11	17	25	47	73
	Property class 8.8	$V^0_{Rk,s}$	[kN]	15	23	34	63	98
Stainless steel / High corrosion resistant steel	Property class 70	$V^0_{Rk,s}$	[kN]	13	20	30	55	86
	Property class 80	$V^0_{Rk,s}$	[kN]	15	23	34	63	98
Steel failure <u>with</u> lever arm								
Steel, zinc plated	Property class 5.8	$M^0_{Rk,s}$	[Nm]	19	37	65	166	325
	Property class 8.8	$M^0_{Rk,s}$	[Nm]	30	60	105	266	519
Stainless steel / High corrosion resistant steel	Property class 70	$M^0_{Rk,s}$	[Nm]	26	52	92	233	454
	Property class 80	$M^0_{Rk,s}$	[Nm]	30	60	105	266	519
Partial factor ¹⁾								
Steel, zinc plated	Property class 5.8	$\gamma_{Ms,V}$	[-]	1,25				
	Property class 8.8	$\gamma_{Ms,V}$	[-]	1,25				
Stainless steel / High corrosion resistant steel	Property class 70	$\gamma_{Ms,V}$	[-]	1,56				
	Property class 80	$\gamma_{Ms,V}$	[-]	1,33				

¹⁾ In absence of other national regulations

Capsule Adhesive Anchor VZ

Performance
Characteristic **steel resistance** under **tension** and **shear load**

Annex C1

Table C3: Characteristic values for tension load

Anchor size			M8	M10	M12	M16	M20	
Steel failure								
Characteristic resistance under tension load								
Characteristic tension resistance	$N_{Rk,s}$	[kN]	see Table C1					
Partial factor	$\gamma_{Ms,N}$	[-]	see Table C1					
Combined pull-out and concrete failure								
Characteristic bond resistance in <u>uncracked</u> concrete C20/25								
Temperature range I:	+24°C / +40°C	$\tau_{Rk,ucr}$	[N/mm ²]	10,0	13,0	13,0	13,0	13,0
Temperature range II:	+50°C / +80°C	$\tau_{Rk,ucr}$	[N/mm ²]	8,5	11,0	11,0	11,0	11,0
Increasing factors for <u>uncracked</u> concrete	ψ_c	[-]	$\left(\frac{f_{ck}}{20}\right)^{0,17}$					
Characteristic bond resistance in <u>cracked</u> concrete C20/25								
Temperature range I:	+24°C / +40°C	$\tau_{Rk,cr}$	[N/mm ²]	5,0	6,5	7,0	7,5	7,5
Temperature range II:	+50°C / +80°C	$\tau_{Rk,cr}$	[N/mm ²]	4,5	5,5	6,0	6,0	6,0
Increasing factors for <u>cracked</u> concrete	ψ_c	[-]	$\left(\frac{f_{ck}}{20}\right)^{0,14}$					
Reduction factor ψ_{sus}^0 in concrete C20/25								
Temperature range I:	+24°C / +40°C	ψ_{sus}^0	[-]	0,64				
Temperature range II:	+50°C / +80°C	ψ_{sus}^0	[-]	0,63				
Concrete cone failure								
Factor k_1	uncracked concrete	$k_{ucr,N}$	[-]	11,0				
	cracked concrete	$k_{cr,N}$	[-]	7,7				
Edge distance		$c_{cr,N}$	[mm]	1,5 h_{ef}				
Spacing		$s_{cr,N}$	[mm]	3 h_{ef}				
Splitting failure								
Edge distance	$h/h_{ef} \geq 2,0$	$c_{cr,sp}$	[mm]	1,0 h_{ef}				
	$2,0 > h/h_{ef} > 1,3$			$2 \cdot h_{ef} (2,5 - h / h_{ef})$				
	$h/h_{ef} \leq 1,3$			2,4 h_{ef}				
Spacing		$s_{cr,sp}$	[mm]	2 $c_{cr,sp}$				
Installation factor		γ_{inst}	[-]	1,2				

Capsule Adhesive Anchor VZ

Performance
Characteristic values under **tension load**

Annex C2

Table C4: Characteristic values for shear loads

Anchor size			M8	M10	M12	M16	M20
Steel failure <u>without</u> lever arm							
Characteristic shear resistance	$V^0_{Rk,s}$	[kN]	see Table C2				
Ductility factor	k_7	[-]	1,0				
Partial factor	$\gamma_{Ms,V}$	[-]	see Table C2				
Steel failure <u>with</u> lever arm							
Characteristic bending resistance	$M^0_{Rk,s}$	[Nm]	see Table C2				
Partial factor	$\gamma_{Ms,V}$	[-]	see Table C2				
Concrete pry-out failure							
Pry-out factor	k_8	[-]	2,0				
Concrete edge failure							
Effective length of anchor	l_f	[mm]	min (h_{ef} ; 12 d_{nom})				
Outside diameter of anchor	d_{nom}	[mm]	8	10	12	16	20
Installation factor	γ_{inst}	[-]	1,0				

Capsule Adhesive Anchor VZ

Performance
 Characteristic values under **shear load**

Annex C3

Table C5: Displacements under tension load

Anchor size			M8	M10	M12	M16	M20
Displacement factor¹⁾ for uncracked concrete							
Displacement	δ_{N0} -factor	[mm/(N/mm ²)]	0,015	0,031	0,035	0,015	0,046
	$\delta_{N\infty}$ -factor	[mm/(N/mm ²)]	0,085	0,067	0,067	0,067	0,067
Displacement factor¹⁾ for cracked concrete							
Displacement	δ_{N0} -factor	[mm/(N/mm ²)]	0,046	0,038	0,024	0,008	0,024
	$\delta_{N\infty}$ -factor	[mm/(N/mm ²)]	0,192	0,142	0,090	0,104	0,082

¹⁾ Calculation of the displacement

$$\delta_{N0} = \delta_{N0}\text{-factor} \cdot \tau; \quad \tau: \text{acting bond stress for tension}$$

$$\delta_{N\infty} = \delta_{N\infty}\text{-factor} \cdot \tau;$$

Table C6: Displacements under shear load

Anchor size			M8	M10	M12	M16	M20
Displacement factor¹⁾							
Displacement	δ_{V0} -factor	[mm/(kN)]	0,06	0,06	0,05	0,04	0,04
	$\delta_{V\infty}$ -factor	[mm/(kN)]	0,09	0,08	0,08	0,06	0,06

¹⁾ Calculation of the displacement

$$\delta_{V0} = \delta_{V0}\text{-factor} \cdot V; \quad V: \text{acting shear load}$$

$$\delta_{V\infty} = \delta_{V\infty}\text{-factor} \cdot V;$$

Capsule Adhesive Anchor VZ

Performance
Displacements

Annex C4