

## VYHLÁSENIE O PARAMETROCH

DoP č.: MKT-2.5-300\_sk

- ✧ **Jedinečný identifikačný kód typu výrobku:** Kompozitná kotva VZ
- ✧ **Zamýšľané použitie/použitia:** Kompozitné hmoždinky na ukotvenie do betónu, vid' príloha / Annex B
- ✧ **Výrobca:** MKT Metall-Kunststoff-Technik GmbH & Co.KG  
Auf dem Immel 2  
67685 Weilerbach
- ✧ **Systém (y) na hodnotenie a overovanie stálosti úžitkových vlastností:** 1
- ✧ **Európsky hodnotiaci dokument:** EAD 330499-01-0601  
Európske technické posúdenie: ETA-20/0533, 17.04.2021  
Orgán technického posudzovania: DIBt, Berlin  
Notifikovaný(-é) subjekt(-y): NB 2873 – Technische Universität Darmstadt

✧ **Deklarované parametre:**

Podstatné vlastnosti	Parametre
<b>Mechanická odolnosť a stabilita (BWR 1)</b>	
Charakteristické odpory pri ťahovom zaťažení (statické a kvázistatické účinky)	Príloha / Annex C1, C2, B2
Charakteristické odpory pri priečnom namáhaní (statické a kvázistatické účinky)	Príloha / Annex C1, C3
Posuny (statické a kvázistatické účinky)	Príloha / Annex C4
Charakteristická odolnosť a posuny pre kategóriu seizmických vlastností C1 + C2	Výkon nie je hodnotený
<b>Hygiena, zdravie a životné prostredie (BWR 3)</b>	
Obsah, emisie a / alebo uvoľňovanie nebezpečných látok	Výkon nie je hodnotený

Výkonnosť vyššie uvedeného produktu je deklarovaná úžitková vlastnosť / výkon. Uvedený výrobca je zodpovedný výlučne za vypracovanie vyhlásenia o úžitkových vlastnostiach v súlade s nariadením (EÚ) č. 305/2011.

Podpísal(-a) za a v mene výrobcu:

  
**Stefan Weustenhagen**  
(Generálny riaditeľ)  
Weilerbach, 17.04.2021

p.p.   
**Dipl.-Ing. Detlef Bigalke**  
(Vedúci vývoja produktov)



Originál tohto vyhlásenia o úžitkových vlastnostiach bol napísaný v nemčine. Pre odchýlky v preklade platí nemecká verzia.

## Specifications of intended use

Anchor size	M8	M10	M12	M16	M20
Static or quasi-static action	✓				
Base materials	compacted, reinforced or unreinforced normal weight concrete without fibers acc. to EN 206:2013+A1:2016				
	strength classes C20/25 to C50/60, acc. to EN 206:2013+A1:2016				
	cracked or uncracked concrete				
Temperature range I	-40°C to +40°C	max long term temperature +24°C; max short term temperature +40°C			
Temperature range II	-40°C to +80°C	max long term temperature +50°C; max short term temperature +80°C			

### Use conditions (Environmental conditions):

- Structures subject to dry internal conditions: all versions
- For all other conditions corresponding to corrosion resistance classes CRC according to EN 1993-1-4:2015, Annex A, Table A.2:
  - V-A A2: CRC II
  - V-A A4: CRC III
  - V-A HCR: CRC V

### Design:

- Verifiable calculation notes and drawings are prepared taking account of the loads to be anchored. The position of the anchor is indicated on the design drawings (e.g. position of the anchor relative to reinforcement or to supports, etc.)
- Anchorages are designed under the responsibility of an engineer experienced in anchorages and concrete work
- Anchorages are designed according to EN 1992-4:2018 or TR 055, version February 2018

### Installation:

- Dry or wet concrete
- Making of drill hole by hammer drilling, compressed air drilling or vacuum drilling
- Installation direction: D3 - downwards, horizontally and upwards (e.g. overhead) installation

Intended use  
Specifications

**Annex B1**

**Table B1: Installation parameters**

Anchor size			M8	M10	M12	M16	M20
Diameter of threaded rod	$d=d_{nom}$	[mm]	8	10	12	16	20
Nominal diameter of drill hole	$d_0$	[mm]	10	12	14	18	22
Depth of drill hole	$h_0$	[mm]	80	90	110	125	170
Effective anchorage depth	$h_{ef}$	[mm]	80	90	110	125	170
Diameter of clearance hole in the fixture	$d_f$	[mm]	9	12	14	18	22
Cleaning Brush		[-]	RB 10	RB 12	RB 14	RB 18	RB 22
Diameter of Cleaning Brush	$d_b \geq$	[mm]	10,5	12,5	14,5	18,5	22,5
Maximum installation torque	$\max T_{inst}$	[Nm]	10	20	40	80	150

**Supplies**

**Vacuum drill bit**



Vacuum drill bit (MKT Hollow drill bit SB, Würth extraction drill bit or Heller Duster Expert) and a class M vacuum with minimum negative pressure of 253 hPa and a flow rate of minimum 42 l/s

**Blow-out pump (volume 750ml)**



**Cleaning Brush RB**



**Table B2: Minimum member thickness, edge distance and spacing**

Anchor size			M8	M10	M12	M16	M20
Minimum member thickness	$h_{min}$	[mm]	110	120	140	160	220
Minimum edge distance	$c_{min}$	[mm]	40	45	45	50	55
Minimum spacing	$s_{min}$	[mm]	40	50	60	75	90

**Table B3: Curing time**

Concrete temperature	Minimum curing time
-20°C to -16°C	17 h
-15°C to -11°C	7 h
-10°C to -6°C	4 h
-5°C to -1°C	3 h
0°C to +4°C	50 min
+5°C to +9°C	25 min
+10°C to +19°C	15 min
+20°C to +29°C	6 min
+30°C to +40°C	6 min
<b>Capsule temperature</b>	<b>-15°C to +40°C</b>

**Capsule Adhesive Anchor VZ**

**Intended use**

Installation parameters, edge distance and spacing, Curing time

**Annex B2**

# Installation instructions

## Drilling

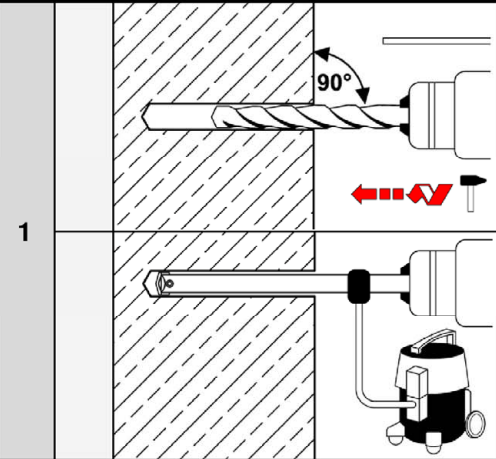

**Hammer drill or compressed air drill:**  
 Drill the hole with diameter and depth according to Table B1.  
 Continue with step 2.

**Vacuum drill:** see Annex B2  
 Drill the hole with diameter and depth according to Table B1.  
 Additional cleaning is not necessary - continue with step 3.

## Cleaning

Drill hole must be cleaned directly before installation of the anchor, or it must be protected against recontamination in a suitable manner until installation of the anchor.

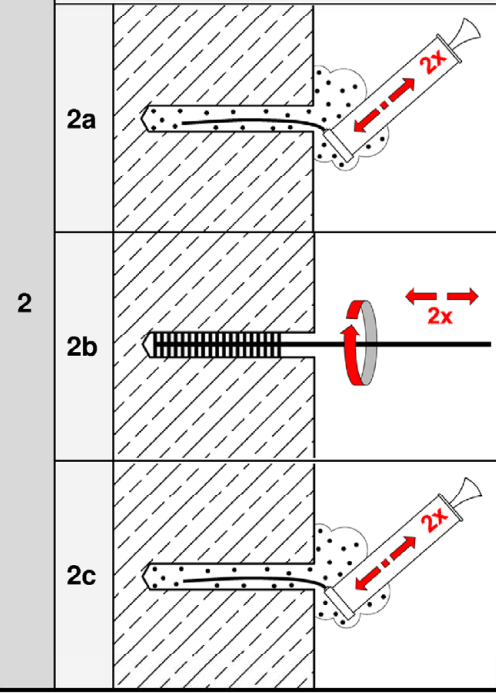

Blow out the drill hole completely at least **2x** from the bottom of the drill hole with blow-out pump or compressed air.

Brush the drill hole **2x** with Cleaning Brush RB (Table B1).  
 Observe and check brush diameter  $d_{b,min}$ . When inserting the brush into the drill hole, a clear resistance must be noticeable.  
 Otherwise use a new Cleaning Brush.

Blow out the drill hole completely at least **2x** from the bottom of the drill hole with blow-out pump or compressed air.

## Capsule Adhesive Anchor VZ

Intended use  
 Installation instructions

Annex B3

## Installation instructions - continuation

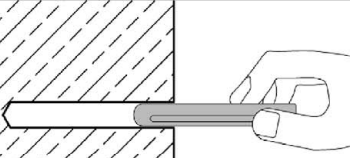
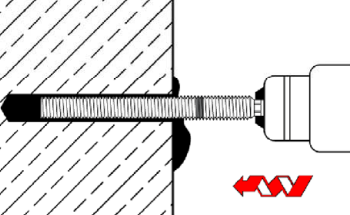
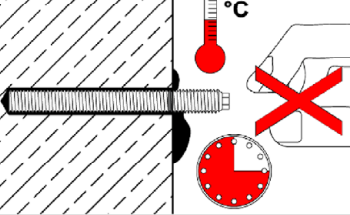
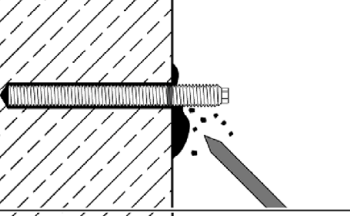
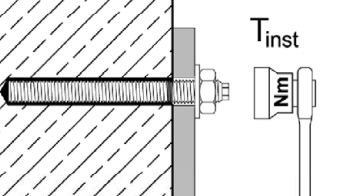
Inserting the threaded rod		
3		Insert the capsule into the drill hole.
4		Drive in the anchor rod using a hammer drill set on rotary impact. Stop immediately after reaching the setting depth.
5		Observe curing time according to Table B3. Do not move or load the anchor until it is fully cured.
6		Remove excess adhesive.
7		Install fixture and apply installation torque $T_{inst}$ according to Table B1.

### Capsule Adhesive Anchor VZ

#### Intended Use

Installation instructions - continuation

Annex B4

**Table C1: Characteristic steel resistance under tension load**

Anchor size				M8	M10	M12	M16	M20
<b>Steel failure</b>								
<b>Characteristic resistance under tension load</b>								
Steel, zinc plated	Property class 5.8	$N_{Rk,s}$	[kN]	18	29	42	79	123
	Property class 8.8	$N_{Rk,s}$	[kN]	29	46	67	126	196
Stainless steel / High corrosion resistant steel	Property class 70	$N_{Rk,s}$	[kN]	26	41	59	110	172
	Property class 80	$N_{Rk,s}$	[kN]	29	46	67	126	196
<b>Partial factor <sup>1)</sup></b>								
Steel, zinc plated	Property class 5.8	$\gamma_{Ms,N}$	[-]	1,5				
	Property class 8.8	$\gamma_{Ms,N}$	[-]	1,5				
Stainless steel / High corrosion resistant steel	Property class 70	$\gamma_{Ms,N}$	[-]	1,87				
	Property class 80	$\gamma_{Ms,N}$	[-]	1,6				

<sup>1)</sup> In absence of other national regulations

**Table C2: Characteristic steel resistance under shear load**

Anchor size				M8	M10	M12	M16	M20
<b>Characteristic resistances under shear load</b>								
<b>Steel failure <u>without</u> lever arm</b>								
Steel, zinc plated	Property class 5.8	$V^0_{Rk,s}$	[kN]	11	17	25	47	73
	Property class 8.8	$V^0_{Rk,s}$	[kN]	15	23	34	63	98
Stainless steel / High corrosion resistant steel	Property class 70	$V^0_{Rk,s}$	[kN]	13	20	30	55	86
	Property class 80	$V^0_{Rk,s}$	[kN]	15	23	34	63	98
<b>Steel failure <u>with</u> lever arm</b>								
Steel, zinc plated	Property class 5.8	$M^0_{Rk,s}$	[Nm]	19	37	65	166	325
	Property class 8.8	$M^0_{Rk,s}$	[Nm]	30	60	105	266	519
Stainless steel / High corrosion resistant steel	Property class 70	$M^0_{Rk,s}$	[Nm]	26	52	92	233	454
	Property class 80	$M^0_{Rk,s}$	[Nm]	30	60	105	266	519
<b>Partial factor <sup>1)</sup></b>								
Steel, zinc plated	Property class 5.8	$\gamma_{Ms,V}$	[-]	1,25				
	Property class 8.8	$\gamma_{Ms,V}$	[-]	1,25				
Stainless steel / High corrosion resistant steel	Property class 70	$\gamma_{Ms,V}$	[-]	1,56				
	Property class 80	$\gamma_{Ms,V}$	[-]	1,33				

<sup>1)</sup> In absence of other national regulations

**Capsule Adhesive Anchor VZ**

**Performance**  
Characteristic **steel resistance** under **tension** and **shear load**

**Annex C1**

**Table C3: Characteristic values for tension load**

Anchor size			M8	M10	M12	M16	M20	
<b>Steel failure</b>								
<b>Characteristic resistance under tension load</b>								
Characteristic tension resistance	$N_{Rk,s}$	[kN]	see Table C1					
Partial factor	$\gamma_{Ms,N}$	[-]	see Table C1					
<b>Combined pull-out and concrete failure</b>								
<b>Characteristic bond resistance in <u>uncracked</u> concrete C20/25</b>								
Temperature range I:	+24°C / +40°C	$\tau_{Rk,ucr}$	[N/mm <sup>2</sup> ]	10,0	13,0	13,0	13,0	13,0
Temperature range II:	+50°C / +80°C	$\tau_{Rk,ucr}$	[N/mm <sup>2</sup> ]	8,5	11,0	11,0	11,0	11,0
Increasing factors for <u>uncracked</u> concrete	$\psi_c$	[-]	$\left(\frac{f_{ck}}{20}\right)^{0,17}$					
<b>Characteristic bond resistance in <u>cracked</u> concrete C20/25</b>								
Temperature range I:	+24°C / +40°C	$\tau_{Rk,cr}$	[N/mm <sup>2</sup> ]	5,0	6,5	7,0	7,5	7,5
Temperature range II:	+50°C / +80°C	$\tau_{Rk,cr}$	[N/mm <sup>2</sup> ]	4,5	5,5	6,0	6,0	6,0
Increasing factors for <u>cracked</u> concrete	$\psi_c$	[-]	$\left(\frac{f_{ck}}{20}\right)^{0,14}$					
<b>Reduction factor <math>\psi_{sus}^0</math> in concrete C20/25</b>								
Temperature range I:	+24°C / +40°C	$\psi_{sus}^0$	[-]	0,64				
Temperature range II:	+50°C / +80°C	$\psi_{sus}^0$	[-]	0,63				
<b>Concrete cone failure</b>								
Factor $k_1$	uncracked concrete	$k_{ucr,N}$	[-]	11,0				
	cracked concrete	$k_{cr,N}$	[-]	7,7				
Edge distance		$c_{cr,N}$	[mm]	1,5 $h_{ef}$				
Spacing		$s_{cr,N}$	[mm]	3 $h_{ef}$				
<b>Splitting failure</b>								
Edge distance	$h/h_{ef} \geq 2,0$	$c_{cr,sp}$	[mm]	1,0 $h_{ef}$				
	$2,0 > h/h_{ef} > 1,3$			$2 \cdot h_{ef} (2,5 - h / h_{ef})$				
	$h/h_{ef} \leq 1,3$			2,4 $h_{ef}$				
Spacing		$s_{cr,sp}$	[mm]	2 $c_{cr,sp}$				
Installation factor		$\gamma_{inst}$	[-]	1,2				

**Capsule Adhesive Anchor VZ**

**Performance**  
Characteristic values under **tension load**

**Annex C2**

**Table C4: Characteristic values for shear loads**

Anchor size			M8	M10	M12	M16	M20
<b>Steel failure <u>without</u> lever arm</b>							
Characteristic shear resistance	$V^0_{Rk,s}$	[kN]	see Table C2				
Ductility factor	$k_7$	[-]	1,0				
Partial factor	$\gamma_{Ms,V}$	[-]	see Table C2				
<b>Steel failure <u>with</u> lever arm</b>							
Characteristic bending resistance	$M^0_{Rk,s}$	[Nm]	see Table C2				
Partial factor	$\gamma_{Ms,V}$	[-]	see Table C2				
<b>Concrete pry-out failure</b>							
Pry-out factor	$k_8$	[-]	2,0				
<b>Concrete edge failure</b>							
Effective length of anchor	$l_f$	[mm]	min ( $h_{ef}$ ; 12 $d_{nom}$ )				
Outside diameter of anchor	$d_{nom}$	[mm]	8	10	12	16	20
Installation factor	$\gamma_{inst}$	[-]	1,0				

**Capsule Adhesive Anchor VZ**

**Performance**  
 Characteristic values under **shear load**

**Annex C3**



**Table C5: Displacements under tension load**

Anchor size			M8	M10	M12	M16	M20
<b>Displacement factor<sup>1)</sup> for uncracked concrete</b>							
Displacement	$\delta_{N0}$ -factor	[mm/(N/mm <sup>2</sup> )]	0,015	0,031	0,035	0,015	0,046
	$\delta_{N\infty}$ -factor	[mm/(N/mm <sup>2</sup> )]	0,085	0,067	0,067	0,067	0,067
<b>Displacement factor<sup>1)</sup> for cracked concrete</b>							
Displacement	$\delta_{N0}$ -factor	[mm/(N/mm <sup>2</sup> )]	0,046	0,038	0,024	0,008	0,024
	$\delta_{N\infty}$ -factor	[mm/(N/mm <sup>2</sup> )]	0,192	0,142	0,090	0,104	0,082

<sup>1)</sup> Calculation of the displacement

$$\delta_{N0} = \delta_{N0}\text{-factor} \cdot \tau; \quad \tau: \text{acting bond stress for tension}$$

$$\delta_{N\infty} = \delta_{N\infty}\text{-factor} \cdot \tau;$$

**Table C6: Displacements under shear load**

Anchor size			M8	M10	M12	M16	M20
<b>Displacement factor<sup>1)</sup></b>							
Displacement	$\delta_{V0}$ -factor	[mm/(kN)]	0,06	0,06	0,05	0,04	0,04
	$\delta_{V\infty}$ -factor	[mm/(kN)]	0,09	0,08	0,08	0,06	0,06

<sup>1)</sup> Calculation of the displacement

$$\delta_{V0} = \delta_{V0}\text{-factor} \cdot V; \quad V: \text{acting shear load}$$

$$\delta_{V\infty} = \delta_{V\infty}\text{-factor} \cdot V;$$

**Capsule Adhesive Anchor VZ**

**Performance**  
Displacements

**Annex C4**