



... eine starke Verbindung

## IZJAVA O SVOJSTVIMA

DoP br. **MKT-1.3-300\_hr**

- ❖ **Jedinstvena identifikacijska oznaka vrste proizvoda:** **Beton vijak BSZ2**
- ❖ **Namjena/namjene:** Mehaničko sidro za sidrenje u betonu, vidi Prilog/Annex B
- ❖ **Proizvođač:** MKT Metall-Kunststoff-Technik GmbH & Co.KG  
Auf dem Immel 2  
67685 Weilerbach
- ❖ **Sustav ili sustavi ocjenjivanja i provjere stalnosti svojstava građevnog proizvoda:** 1
- ❖ **Europski dokument za ocjenjivanje:** **EAD 330232-01-0601**  
Europska tehnička ocjena: **ETA-22/0551, 24.10.2022**  
Tijelo za tehničko ocjenjivanje: DIBt, Berlin  
Prijavljeno tijelo/prijavljena tijela: NB 2873 – Technische Universität Darmstadt

### ❖ **Objavljena svojstva:**

Bitnih značajka	Svojstva
<b>TEMELJNI ZAHTJEVI ZA GRAĐEVINE (BWR 1)</b>	
Karakteristični otpori pod vlačnim opterećenjem (statički i kvazi-statički efekti)	Prilog / Annex B2, C1
Karakteristični otpori pod poprečnim naprežanjem (statički i kvazi-statički efekti)	Prilog / Annex C2
Karakteristični otpor i pomaci za seizmičke performanse kategorije C1	Prilog / Annex C3
Pomaci (statički i kvazi-statički efekti)	Prilog / Annex C5
Trajnost	Prilog / Annex B1
<b>Sigurnost u slučaju požara (BWR 2)</b>	
Ponašanje požara	Klasa A1
Otpornost na vatru	Prilog / Annex C4

Izvedba gore navedenog proizvoda je deklarirana izvedba / izvedba. Gore navedeni proizvođač jedini je odgovoran za sastavljanje izjave o učinkovitosti u skladu s Uredbom (EU) br. 305/2011.

Za proizvođača i u njegovo ime potpisao:

  
**Stefan Weustenhagen**  
 (generalni direktor)  
**Weilerbach, 24.10.2022**

p.p.   
**Dipl.-Ing. Detlef Bigalke**  
 (Voditelj razvoja proizvoda)



Izvornik ove izjave o izvedbi pisan je na njemačkom jeziku. U slučaju odstupanja u prijevodu vrijedi njemačka verzija.

## Specifications of Intended use

Concrete screw BSZ		BSZ2 6			BSZ2 8			BSZ2 10		
Nominal embedment depth	$h_{nom}$ [mm]	$h_{nom1}^{1)}$	$h_{nom2}$	$h_{nom3}$	$h_{nom1}$	$h_{nom2}$	$h_{nom3}$	$h_{nom1}$	$h_{nom2}$	$h_{nom3}$
		35	45	55	45	55	65	55	75	85
Anchorage subject to	Static or quasi-static action	✓								
	Fire exposure	✓								
	Seismic action, performance category C1	Tension load: all anchor types		Shear load: anchor types B, S, SK, LK						
		2)	✓	✓	✓	2)	✓	✓	2)	✓
Base material	Cracked or uncracked concrete	✓								
	Compacted, reinforced or unreinforced concrete without fibres acc. to EN 206:2013+A1:2016	✓								
	Strength classes according to EN 206:2013+A1:2016, C20/25 to C50/60	✓								

1) Only for statically indeterminate non-structural systems (multiple use) according to EN 1992-4:2018, in dry internal conditions.

2) no performance assessed

### Use conditions (Environmental conditions):

- Structures subject to dry internal conditions: all screw types
- For all other conditions corresponding to corrosion resistance classes CRC according to EN 1993-1-4:2006 +A1:2015:
  - stainless steel A4, according to Annex A3, Table A3: CRC III
  - high corrosion resistant steel HCR, according to Annex A3, Table A3: CRC V

### Design:

- Anchorage are designed under the responsibility of an engineer experienced in anchorages and concrete work.
- Verifiable calculation notes and drawings are prepared taking account of the loads to be anchored. The position of the anchor is indicated on the design drawings (e.g. position of the anchor relative to reinforcement or to supports, etc.)
- Design method of anchorages according to EN 1992-4:2018 (if required in connection with EOTA Technical Report TR 055, version February 2018)

### Installation:

- Making of drill hole by hammer drilling (all sizes) or vacuum drilling (BSZ 8 und BSZ 10). When using a vacuum drill bit no drill hole cleaning is required.
- Anchor installation carried out by appropriately qualified personal and under the responsibility of the person responsible for technical matters on site.
- After installation further turning of the anchor is not possible. The head of the anchor is supported on the fixture and is not damaged.
- The borehole may be filled with the Injection System VME plus.
- Adjustment according to Annex B4 (except for anchorages with filled borehole and anchorages with seismic action).

<b>Concrete Screw BSZ2</b>	<b>Annex B1</b>
<b>Intended Use Specifications</b>	

**Table B1: Installation parameters**

Screw size			BSZ2 6			BSZ2 8			BSZ2 10		
Nominal embedment depth	$h_{nom}$	[mm]	35 <sup>1)</sup>	45	55	45	55	65	55	75	85
Nominal drill bit diameter	$d_0$	[mm]	6			8			10		
Cutting diameter of drill bit	$d_{cut} \leq$	[mm]	6,40			8,45			10,45		
Depth of drill hole	$h_0 \geq$	[mm]	40	50	60	55	65	75	65	85	95
Diameter of clearance hole in the fixture	$d_f \leq$	[mm]	8			12			14		
Max. installation torque for screws with metric connection thread	$T_{inst} \leq$	[Nm]	10			20			40		
Tangential impact screw driver <sup>2)</sup>	$T_{imp,max}$	[Nm]	160			300			450		

<sup>1)</sup> Only for statically indeterminate non-structural systems (multiple use) according to EN 1992-4:2018, in dry internal conditions.

<sup>2)</sup> Installation with tangential impact screw driver, with maximum torque  $T_{imp,max}$  acc. to manufacturer's instructions is possible.

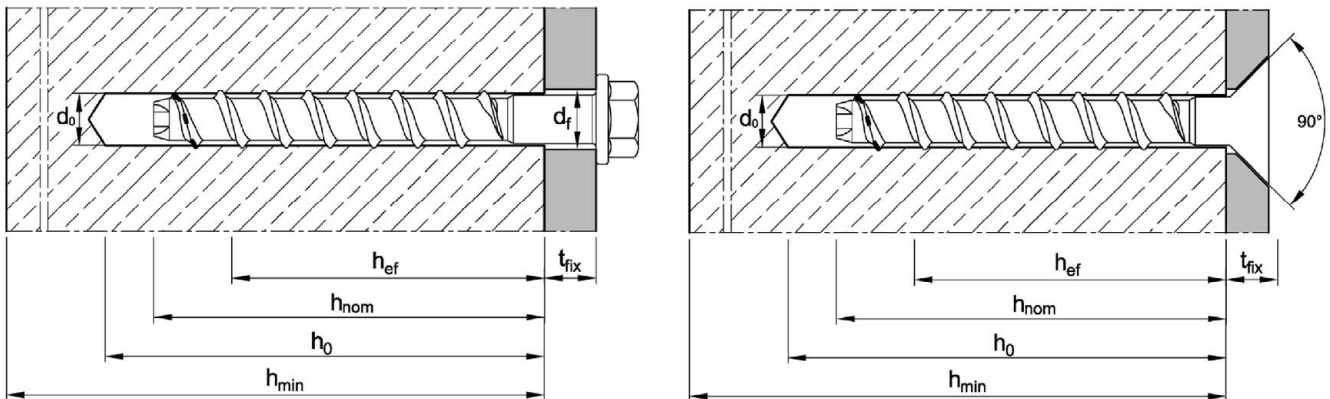

**Table B2: Minimum thickness of member, minimum edge distance and minimum spacing**

Screw size			BSZ2 6			BSZ2 8			BSZ2 10		
Nominal embedment depth	$h_{nom}$	[mm]	35 <sup>1)</sup>	45	55	45	55	65	55	75	85
Minimum thickness of member	$h_{min}$	[mm]	80	80	100	80	100	120	100	130	130
Minimum spacing	$s_{min}$	[mm]	35			35			40		
Minimum edge distance	$c_{min}$	[mm]	35			35			40		

<sup>1)</sup> Only for statically indeterminate non-structural systems (multiple use) according to EN 1992-4:2018, in dry internal conditions.

**Concrete Screw BSZ2**

**Intended Use**

Installation parameters / Minimum thickness of concrete member, minimum spacing and edge distance

**Annex B2**

# Installation instructions

Drill hole preparation and cleaning		
1		<p>Drill hole perpendicular to concrete surface. Using a vacuum drill, continue with step 3.</p>
2		<p>Blow out dust or alternatively vacuum clean down to the bottom of the hole.</p>
Installation concrete screw		
3		<p>Screw in, e.g. with tangential impact screw driver or torque wrench.</p>
4		<p>After installation, the head of the anchor is supported on the fixture and must be undamaged.</p>
<p>For screw size BSZ2 6 with <math>h_{nom} = 35</math> mm, installation only with impact screw drivers.</p>		

## Concrete Screw BSZ2

**Intended Use**  
Installation instructions

**Annex B3**

# Installation instructions - Adjustment

1. Adjustment		
5		Screw may be untightened maximum 10 mm.
6		After adjustment, screw in the concrete screw with tangential impact screw driver or torque wrench.
7		After installation, the head of the anchor is supported on the fixture must be undamaged.
2. Adjustment		
8		Screw may be untightened maximum 10 mm.
9		After adjustment, screw in the concrete screw with tangential impact screw driver or torque wrench.
10		After installation, the head of the anchor is supported on the fixture and must be undamaged.
<p>Note:                      The concrete screw may be adjusted max. 2 times. The fastener must not be screwed back by more than 10 mm in each case. The relining carried out during adjustment must not exceed 10 mm in total. Nominal embedment depth <math>h_{nom}</math> must still be maintained after the adjustment.</p>		

## Concrete Screw BSZ2

Intended Use  
 Installation instructions - Adjustment

Annex B4

## Installation instructions - filling of annular gap

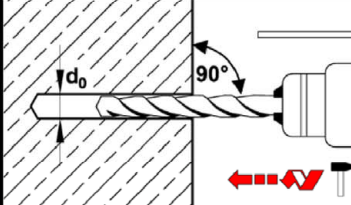
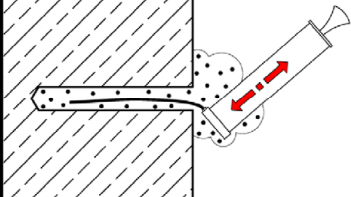
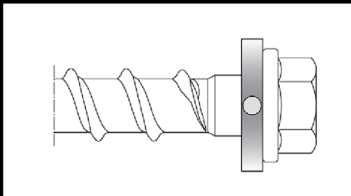
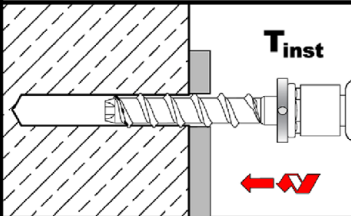
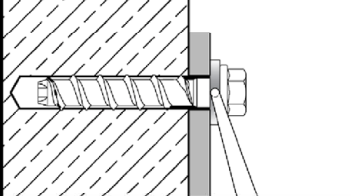
Drill hole preparation and cleaning		
1		<p>Drill hole perpendicular to concrete surface. Using a vacuum drill, continue with step 3.</p>
2		<p>Blow out dust or alternatively vacuum clean down to the bottom of the hole.</p>
Installation concrete screw with filling washer		
3		<p>Fit the filling washer to the concrete screw or position at the attachment. The thickness of the filling washer must be taken into account with <math>t_{fix}</math>.</p>
4		<p>Screw in, e.g. with tangential impact screw driver or torque wrench.</p>
5		<p>Fill the annular gap between concrete screw and fixture with mortar (compressive strength <math>\geq 40 \text{ N/mm}^2</math>, e.g. Injection mortar VMH, VMZ or VMU plus). Use enclosed reducing adapter. Observe information on processing of the mortar! The annular gap is completely filled, when excess mortar seeps out.</p>
<p>For seismic loading, the application <u>with</u> and <u>without</u> filling of annular gap is permitted (Annex C3).</p>		

### Concrete Screw BSZ2

#### Intended Use

Installation instructions - filling of annular gap

Annex B5

**Table C1: Characteristic values for tension load under static or quasi-static action**

Screw size				BSZ2 6			BSZ2 8			BSZ2 10		
Nominal embedment depth	$h_{nom}$	[mm]	35 <sup>1)</sup>	45	55	45	55	65	55	75	85	
Installation factor	$\gamma_{inst}$	[-]	1,0									
<b>Steel failure</b>												
Characteristic resistance	$N_{RK,s}$	[kN]	14,0			27,0			45,0			
Partial factor <sup>2)</sup>	$\gamma_{Ms,N}$	[-]	1,5									
<b>Pull-out failure (concrete strength class C20/25)</b>												
Characteristic resistance	cracked	$N_{RK,p,cr}$	[kN]	2,5	1,5	3,0	3,0	5,5	8,0	6,0	13,0	17,0
	uncracked	$N_{RK,p,ucr}$	[kN]	3,5	4,0	8,5	9,0	12,0	17,0	11,0	19,0	25,0
<b>Exponent <math>m</math> for concrete increasing factor <math>\Psi_c = \left(\frac{f_{ck}}{20}\right)^m</math></b>												
Concrete strength class C25/30 to C50/60				$N_{RK,p} = \psi/c \cdot N_{RK,p} (C20/25)$								
Exponent $m$	cracked	$m$	[-]	0,41	0,35	0,50	0,50	0,50	0,50	0,50	0,39	0,39
	uncracked	$m$	[-]	0,35	0,50	0,38	0,50	0,50	0,30	0,50	0,50	0,50
<b>Splitting failure</b>												
Case 1	Characteristic resistance	$N^0_{RK,sp}$	[kN]	$\min ( N_{RK,p} ; N^0_{RK,c} )$								
	Characteristic edge distance	$C_{cr,sp}$	[mm]	60	80	120	100	120	145	115	140	160
	Characteristic spacing	$S_{cr,sp}$	[mm]	120	160	240	200	240	290	230	280	320
Case 2	Characteristic resistance	$N^0_{RK,sp}$	[kN]	<sup>3)</sup>	2,5	5,5	5,5	8,0	11,0	7,0	15,0	20,0
	Characteristic edge distance	$C_{cr,sp}$	[mm]	<sup>3)</sup>	58	84	64	82	98	80	114	130
	Characteristic spacing	$S_{cr,sp}$	[mm]	<sup>3)</sup>	116	168	128	164	196	160	224	260
<b>Concrete cone failure</b>												
Effective anchorage depth	$h_{ef}$	[mm]	25	34	42	32	41	49	40	57	65	
Factor	cracked	$k_{cr,N}$	[-]	7,7								
	uncracked	$k_{ucr,N}$	[-]	11,0								
Characteristic edge distance	$C_{cr,N}$	[mm]	$1,5 \cdot h_{ef}$									
Characteristic spacing	$S_{cr,N}$	[mm]	$3 \cdot h_{ef}$									

<sup>1)</sup> Only for statically indeterminate non-structural systems (multiple use) according to EN 1992-4:2018, in dry internal conditions.

<sup>2)</sup> In absence of other national regulations.

<sup>3)</sup> No performance assessed.

**Concrete Screw BSZ2**

**Performances**  
Characteristic values for **tension load**

**Annex C1**

**Table C2: Characteristic values for shear load under static or quasi static action**

Screw size			BSZ2 6			BSZ2 8			BSZ2 10					
Nominal embedment depth	$h_{nom}$	[mm]	35 <sup>1)</sup>	45	55	45	55	65	55	75	85			
Installation factor	$\gamma_{inst}$	[-]	1,0											
<b>Steel failure <u>without</u> lever arm</b>														
Characteristic resistance	$V_{RK,s}^0$	[kN]	7,0			13,5			17,0		22,5		34,0	
Partial factor <sup>2)</sup>	$\gamma_{Ms,V}$	[-]	1,25											
Ductility factor	$k_7$	[-]	0,8											
<b>Steel failure <u>with</u> lever arm</b>														
Characteristic bending resistance	$M_{RK,s}^0$	[Nm]	10,9			26,0			56,0					
<b>Concrete pry-out failure</b>														
Pry-out factor	$k_8$	[-]	1,0	1,6		2,1	2,8		2,5					
<b>Concrete edge failure</b>														
Effective length of fastener in shear loading	$l_f = h_{nom}$	[mm]	35	45	55	45	55	65	55	75	85			
Outside diameter of anchor	$d_{nom}$	[mm]	6			8			10					

<sup>1)</sup> Only for statically indeterminate non-structural systems (multiple use) according to EN 1992-4:2018, in dry internal conditions.

<sup>2)</sup> In absence of other national regulations

**Concrete Screw BSZ2**

**Performances**  
Characteristic values for **shear load**

**Annex C2**



**Table C3: Characteristic values for seismic loading, performance category C1**

Screw size			BSZ2 6		BSZ2 8		BSZ2 10		
Nominal embedment depth	$h_{nom}$	[mm]	45	55	45	65	55	85	
Installation factor	$\gamma_{inst}$	[-]	1,0						
<b>Tension load</b> (all types)									
<b>Steel failure</b>									
Characteristic resistance	$N_{Rk,s,C1}$	[kN]	14,0		27,0		45,0		
Partial factor <sup>1)</sup>	$\gamma_{Ms,N}$	[-]	1,5						
<b>Pull-out failure</b>									
Characteristic resistance	$N_{Rk,p,C1}$	[kN]	1,5	3,0	3,0	8,5	6,0	17,0	
<b>Concrete cone failure</b>									
Effective anchorage depth	$h_{ef}$	[mm]	34	42	32	49	40	65	
Edge distance	$c_{cr,N}$	[mm]	$1,5 \cdot h_{ef}$						
Spacing	$s_{cr,N}$	[mm]	$3 \cdot h_{ef}$						
<b>Shear load</b> (Type : B, S, SK, LK)									
<b>Steel failure without lever arm</b>									
Characteristic resistance	Type B, S, LK	$V_{Rk,s,C1}$	[kN]	3,5	4,0	8,0	10,0	14,0	16,0
	Type SK	$V_{Rk,s,C1}$	[kN]	2,5	<sup>2)</sup>	4,5	7,0	14,0	10,0
Partial factor <sup>1)</sup>	$\gamma_{Ms,V}$	[-]	1,25						
<b>with</b> filling of annular gap	$\alpha_{gap}$	[-]	1,0						
<b>without</b> filling of annular gap	$\alpha_{gap}$	[-]	0,5						
<b>Concrete pry-out failure</b>									
Pry-out factor	$k_8$	[-]	1,6		2,1	2,8	2,5		
<b>Concrete edge failure</b>									
Effective length of anchor	$l_f = h_{nom}$	[mm]	45	55	45	65	55	85	
Outside diameter of anchor	$d_{nom}$	[mm]	6		8		10		

<sup>1)</sup> In absence of other national regulations

<sup>2)</sup> No performance assessed

**Concrete Screw BSZ2**

**Performances**  
Characteristic values for seismic loading

**Annex C3**

**Table C4: Characteristic values under fire exposure**

Screw size			BSZ2 6			BSZ2 8			BSZ2 10			
Nominal anchorage depth	$h_{nom}$	[mm]	35 <sup>1)</sup>	45	55	45	55	65	55	75	85	
<b>Steel failure (tension and shear resistance)</b>												
Characteristic resistance	R30	$N_{Rk,s,fi}$ = $V_{Rk,s,fi}$	[kN]	0,9			2,4			4,4		
	R60			0,8			1,7			3,3		
	R90			0,6			1,1			2,3		
	R120			0,4			0,7			1,7		
<b>Steel failure <u>with</u> lever arm</b>												
Characteristic bending resistance	R30	$M^0_{Rk,s,fi}$	[Nm]	0,7			2,4			5,9		
	R60			0,6			1,8			4,5		
	R90			0,5			1,2			3,0		
	R120			0,3			0,9			2,3		
<b>Pull-out failure</b>												
Characteristic resistance	R30-R90	$N_{Rk,p,fi}$	[kN]	0,6	0,4	0,8	0,8	1,4	2,0	1,5	3,3	4,3
	R120	$N_{Rk,p,fi}$	[kN]	0,5	0,3	0,6	0,6	1,1	1,6	1,2	2,6	3,4
<b>Concrete cone failure</b>												
Characteristic resistance	R30-R90	$N^0_{Rk,c,fi}$	[kN]	0,5	1,2	2,0	1,0	1,9	2,9	1,7	4,2	5,9
	R120	$N^0_{Rk,c,fi}$	[kN]	0,4	0,9	1,6	0,8	1,5	2,3	1,4	3,4	4,7
Edge distance	$c_{cr,fi}$	[mm]	$2 \cdot h_{ef}$									
In case of fire attack from more than one side, the minimum edge distance shall be $\geq 300$ mm												
Spacing	$s_{cr,fi}$	[mm]	$4 \cdot h_{ef}$									
<b>Concrete pry-out failure</b>												
Pry-out factor	$k_8$	[-]	1,0	1,6	2,1	2,8	2,5					
The anchorage depth has to be increased for wet concrete by at least 30 mm compared to the given values.												

<sup>1)</sup> Only for statically indeterminate non-structural systems (multiple use) according to EN 1992-4:2018, in dry internal conditions.

**Concrete Screw BSZ2**

**Performances**  
Characteristic values under **fire exposure**

**Annex C4**

**Table C5: Displacements under static or quasi-static loads**

Screw size			BSZ2 6		BSZ2 8			BSZ2 10			
Nominal embedment depth	$h_{nom}$	[mm]	45	55	45	55	65	55	75	85	
<b>Tension load</b>											
cracked concrete	Tension load	N	[kN]	0,72	1,45	1,63	2,74	4,06	3,04	6,22	8,46
	Displacement	$\delta_{N0}$	[mm]	0,19	0,27	0,27	0,53	0,45	0,26	0,58	0,61
		$\delta_{N\infty}$	[mm]	0,55	0,84	0,49	0,66	0,61	0,69	0,92	1,10
uncracked concrete	Tension load	N	[kN]	2,11	4,07	4,24	5,97	8,03	5,42	9,17	12,28
	Displacement	$\delta_{N0}$	[mm]	0,42	0,43	0,33	0,49	0,58	0,84	0,62	0,79
		$\delta_{N\infty}$	[mm]	0,42	0,43	0,58			0,79		
<b>Shear load</b>											
Shear load	V	[kN]	3,3			8,6			16,2		
Displacement	$\delta_{V0}$	[mm]	1,55			2,7			2,7		
	$\delta_{V\infty}$	[mm]	3,1			4,1			4,3		

**Concrete Screw BSZ2**

**Performances**  
Displacements

**Annex C5**