

## TELJESÍTMÉNYNYILATKOZAT

DoP Száma: **MKT-1.1-901\_hu**

- ❖ **A terméktípus egyedi azonosító kódja:** **Wedge horgony BZ3 / BZ3 A4 / BZ3 HCR**
- ❖ **Felhasználás célja(i):** Mechanikus tipli betonhoz,  
lásd a B. Mellékletet / Annex B
- ❖ **Gyártó:** MKT Metall-Kunststoff-Technik GmbH & Co.KG  
Auf dem Immel 2  
67685 Weilerbach
- ❖ **A teljesítmény állandóságának értékelésére és ellenőrzésére szolgáló rendszer vagy rendszerek:** 1
- ❖ **Az európai értékelési dokumentum:** **EAD 330232-01-0601**  
Európai műszaki értékelés: **ETA-19/0619, 10.12.2021**  
A műszaki értékelést végző szerv: DIBt, Berlin  
Bejelentett szerv(ek): NB 2873 – Technische Universität Darmstadt
- ❖ **A nyilatkozatban szereplő teljesítmény(ek):**

Alapvető tulajdonságok	Teljesítmény
<b>Mechanikai szilárdság és állékonyosság (BWR 1)</b>	
Minimális távolság a szélektől és a központtól	Melléklet / Annex B3
Jellemző ellenállás húzóterhelés mellett (statikus és kvázi-statikusan hatások)	Melléklet / Annex C1, C2
Jellemző ellenállás keresztirányú feszültség alatt (statikus és kvázi-statikusan hatások)	Melléklet / Annex C3
Jellemző ellenállás a C1 + C2 szeizmikus teljesítménykategóriáknak	Melléklet / Annex C4
Eltolódásokat	Melléklet / Annex C7, C8
Tartósság	Melléklet / Annex B1
<b>Tűzbiztonság (BWR 2)</b>	
Tűz viselkedést	Osztály A1
Tűz ellenállás	Melléklet / Annex C5, C6

A fent azonosított termék teljesítménye megfelel a bejelentett teljesítmény(ek)nek. A 305/2011/EU rendeletnek megfelelően e teljesítménynyilatkozat kiadásáért kizárólag a fent meghatározott gyártó a felelős.

A gyártó nevében és részéről aláíró személy:

  
**Stefan Weustenhagen**  
(Vezérigazgató)  
**Weilerbach, 10.12.2021**

p.p.   
**Dipl.-Ing. Detlef Bigalke**  
(A termékfejlesztés vezetője)



A teljesítménynyilatkozat eredeti példányát németül írták. A fordítás eltérése esetén a német változat érvényes.

## Specifications of intended use

Wedge Anchor	BZ3 / BZ3 A4 / BZ3 HCR			
	M8	M10	M12	M16
Static or quasi-static action	✓			
Seismic performance categories C1 and C2	✓			
Fire exposure	R30 / R60 / R90 / R120			
Variable, effective anchorage depth	35 mm to 90 mm	40 mm to 100 mm	50 mm to 125 mm	65 mm to 160 mm

### Base materials:

- Cracked or uncracked concrete
- Reinforced or unreinforced normal weight concrete without fibres according to EN 206:2013 + A1:2016
- Strength classes C20/25 to C50/60 according to EN 206:2013 + A1:2016

### Use conditions (Environmental conditions):

- Structures subject to dry internal conditions: all materials
- For all other conditions according to EN 1993-1-2006 + A1:2015-10, corresponding to corrosion resistance classes CRC according to Annex A3, Table A2

### Design:

- Anchorages are designed under the responsibility of an engineer experienced in anchorages and concrete work.
- Verifiable calculation notes and drawings are prepared taking account of the loads to be anchored.
- The position of the fastener is indicated on the design drawings (e.g. position of the fastener relative to reinforcement or to supports, etc.).
- Design method EN 1992-4:2018 and Technical Report TR 055:2018

### Installation:

- Hole drilling by hammer drill bit or vacuum drill bit
- Use of the fastener only as supplied by the manufacturer without exchanging the components of the fastener (exception: when using the cap nut HM)
- The anchor can be set in pre- or through-setting installation.
- Optionally, the annular gap between fixture and stud of BZ3 can be filled to reduce the hole clearance. For this purpose, the filling washer (Annex A3) must be used in addition to the supplied washer. For filling use MKT Injection Adhesive VMH, VMU plus, VMZ or other high-strength injection mortar with compressive strength  $\geq 40\text{N/mm}^2$ .

<b>Wedge Anchor BZ3 / BZ3 A4 / BZ3 HCR</b>	<b>Annex B1</b>
<b>Intended use</b> Specifications	

**Table B1: Installation parameters**

Anchor size			BZ3 / BZ3 A4 / BZ3 HCR				
			M8	M10	M12	M16	
Nominal drill hole diameter	$d_0$	[mm]	8	10	12	16	
Cutting diameter of drill bit	$d_{cut} \leq$	[mm]	8,45	10,45	12,5	16,5	
Minimum effective anchorage depth	$h_{ef,min}$	[mm]	35	40	50	65	
Maximum effective anchorage depth	$h_{ef,max}$	[mm]	90	100	125	160	
Depth of drill hole	$h_0 \geq$	[mm]	$h_{ef} + 8$	$h_{ef} + 9$	$h_{ef} + 10$	$h_{ef} + 14$	
	$h_1 \geq$	[mm]	$h_{ef} + 10$	$h_{ef} + 11$	$h_{ef} + 13$	$h_{ef} + 17$	
Diameter of clearance hole in the fixture <sup>1)</sup>	$d_f \leq$	[mm]	9	12	14	18	
Projection after anchor has been inserted for installing with cap nut HM (according to Annex B6, Figure 3)	C	[mm]	10,5	12,5	16,0	19,5	
Installation torque	BZ3	$T_{inst}$	[Nm]	15	40	60	110
	BZ3 A4 / HCR	$T_{inst}$	[Nm]	15	40	55	100

<sup>1)</sup> For larger diameters of clearance hole in the fixture, see EN 1992-4:2018, chapter 6.2.2.2

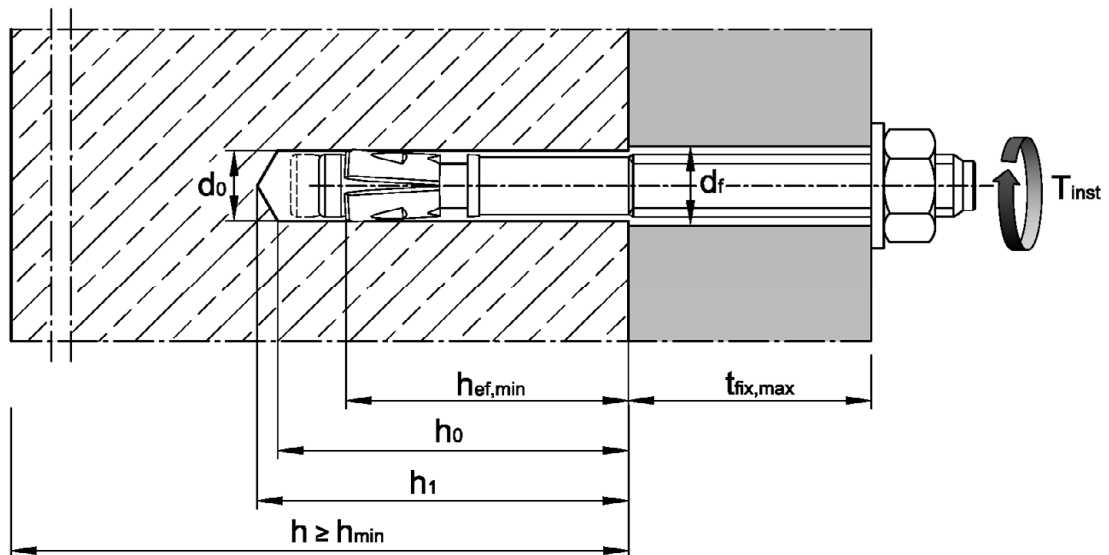

**Wedge Anchor BZ3 / BZ3 A4 / BZ3 HCR**

**Intended use**  
Installation parameters

**Annex B2**

**Table B2: Minimum thickness of concrete member, minimum spacings, edge distances**

Anchor size			BZ3 / BZ3 A4 / BZ3 HCR			
			M8	M10	M12	M16
Minimum member thickness depending on $h_{ef}$	$h_{min} \geq$	[mm]	max (1,5 · $h_{ef}$ ; 80)		max (1,5 · $h_{ef}$ ; 100)	max (1,5 · $h_{ef}$ ; 120)
<b>Minimum edge distances and spacings</b>						
Minimum edge distance	$c_{min}$	[mm]	40	45	55	65
	for $s \geq$	[mm]	see Table B4			
Minimum spacings	$s_{min}$	[mm]	35	40	50	65
	for $c \geq$	[mm]	see Table B4			
<p>The following equation must be fulfilled for the calculation of the minimum spacing and edge distance during installation in combination with variable anchorage depth and member thickness:</p> $A_{sp,req} \leq A_{sp,ef}$ <p>Required splitting area <math>A_{sp,req}</math> and idealized splitting area <math>A_{sp,ef}</math> according to Table B4.</p>						

**Table B3: Applicable concrete thickness  $h_{sp}$  and area  $A_{sp}$  to determine characteristic edge distance  $c_{cr,sp}$**

Anchor size				M8	M10	M12	M16
Applicable concrete thickness	BZ3 BZ3 A4 BZ3 HCR	$h_{sp}$	[mm]	$\min(h ; h_{ef} + 1,5 \cdot c \cdot \sqrt{2})$			
Area to determine $c_{cr,sp}$ <sup>1)</sup>	BZ3	$A_{sp}$	[mm <sup>2</sup> ]	$\frac{N_{Rk,sp}^0 - 2,573}{0,000436}$	$\frac{N_{Rk,sp}^0 + 2,040}{0,000693}$	$\frac{N_{Rk,sp}^0 + 3,685}{0,000692}$	$\frac{N_{Rk,sp}^0 + 3,738}{0,000875}$
	BZ3 A4 BZ3 HCR	$A_{sp}$	[mm <sup>2</sup> ]	$\frac{N_{Rk,sp}^0 + 4,177}{0,000862}$	$\frac{N_{Rk,sp}^0 + 7,235}{0,000967}$	$\frac{N_{Rk,sp}^0 + 7,847}{0,000951}$	$\frac{N_{Rk,sp}^0 + 11,415}{0,000742}$

<sup>1)</sup> with  $N_{Rk,sp}^0$  in kN

<b>Wedge Anchor BZ3 / BZ3 A4 / BZ3 HCR</b>	<b>Annex B3</b>
<b>Intended use</b> Minimum spacings and edge distances Required area and applicable concrete thickness	

**Table B4: Areas to determine spacings and edge distances for installation**

Anchor size	BZ3 / BZ3 A4 / BZ3 HCR						
	M8	M10	M12	M16			
<p>The following equation must be fulfilled for the calculation of the minimum spacing and edge distance during installation in combination with variable anchorage depth and member thickness:</p> $A_{sp,req} \leq A_{sp,ef}$							
<p><b>Idealized splitting area <math>A_{sp,ef}</math></b>                      The edge distances and spacings shall be selected or rounded in steps of 5 mm.</p>							
<p><b>Member thickness: <math>h &gt; h_{ef} + 1,5 \cdot c</math></b></p>							
<p>Single anchor or anchor group with <math>s \geq 3 \cdot c</math></p>							
Effective anchorage depth	$h_{ef} < 1,5 \cdot c$	$A_{sp,ef} = (6 \cdot c) \cdot (1,5 \cdot c + h_{ef})$		[mm <sup>2</sup> ]			
Effective anchorage depth	$h_{ef} \geq 1,5 \cdot c$	$A_{sp,ef} = (6 \cdot c) \cdot (3 \cdot c)$		[mm <sup>2</sup> ]			
<p>Anchor group (<math>s &lt; 3 \cdot c</math>)</p>							
Effective anchorage depth	$h_{ef} < 1,5 \cdot c$	$A_{sp,ef} = (3 \cdot c + s) \cdot (1,5 \cdot c + h_{ef})$		[mm <sup>2</sup> ]			
Effective anchorage depth	$h_{ef} \geq 1,5 \cdot c$	$A_{sp,ef} = (3 \cdot c + s) \cdot (3 \cdot c)$		[mm <sup>2</sup> ]			
<p><b>Member thickness: <math>h \leq h_{ef} + 1,5 \cdot c</math></b></p>							
<p>Single anchor or anchor group with <math>s \geq 3 \cdot c</math></p>							
Effective anchorage depth	$h_{ef} < 1,5 \cdot c$	$A_{sp,ef} = (6 \cdot c) \cdot h$		[mm <sup>2</sup> ]			
Effective anchorage depth	$h_{ef} \geq 1,5 \cdot c$	$A_{sp,ef} = (6 \cdot c) \cdot (h - h_{ef} + 1,5 \cdot c)$		[mm <sup>2</sup> ]			
<p>Anchor group (<math>s &lt; 3 \cdot c</math>)</p>							
Effective anchorage depth	$h_{ef} < 1,5 \cdot c$	$A_{sp,ef} = (3 \cdot c + s) \cdot h$		[mm <sup>2</sup> ]			
Effective anchorage depth	$h_{ef} \geq 1,5 \cdot c$	$A_{sp,ef} = (3 \cdot c + s) \cdot (h - h_{ef} + 1,5 \cdot c)$		[mm <sup>2</sup> ]			
<p><b>Required splitting area <math>A_{sp,req}</math></b></p>							
BZ3	cracked concrete	$A_{sp,req}$	[mm <sup>2</sup> ]	13 900	23 700	31 500	42 300
	uncracked concrete	$A_{sp,req}$	[mm <sup>2</sup> ]	22 500	34 700	41 300	50 200
BZ3 A4	cracked concrete	$A_{sp,req}$	[mm <sup>2</sup> ]	16 900	25 900	29 800	44 300
BZ3 HCR	uncracked concrete	$A_{sp,req}$	[mm <sup>2</sup> ]	19 700	35 700	35 300	54 800

<b>Wedge Anchor BZ3 / BZ3 A4 / BZ3 HCR</b>	<b>Annex B4</b>
<p><b>Intended use</b>                      Projected effective area to determine spacings and edge distances</p>	

## Installation instructions

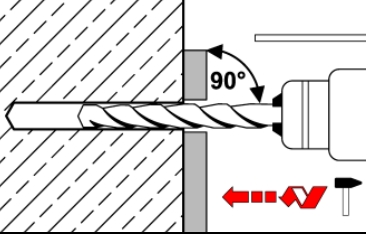
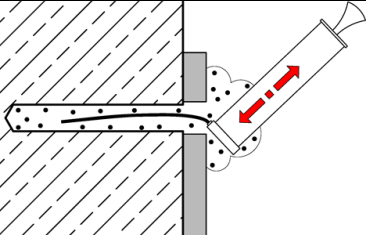
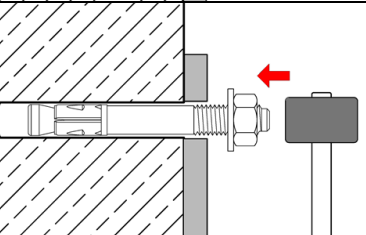
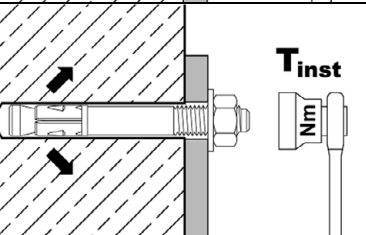
1		<p>Drill hole perpendicular to concrete surface. If using a vacuum drill bit, proceed with step 3.</p>
2		<p>Blow out dust. Alternatively vacuum clean down to the bottom of the hole.</p>
3		<p>Drive in fastener.</p>
4		<p>Apply installation torque <math>T_{inst}</math>.</p>

Wedge Anchor BZ3 / BZ3 A4 / BZ3 HCR

Intended use  
Installation instructions

Annex B5

## Installation with cap nut HM

1		<p>Drill hole perpendicular to concrete surface. If using a vacuum drill bit, proceed with step 3.</p>
2		<p>Blow out dust. Alternatively vacuum clean down to the bottom of the hole.</p>
3		<p>Check position of nut. Projection C after anchor has been inserted see Annex B2, Table B1.</p>
4		<p>Drive in fastener.</p>
5		<p>Remove nut.</p>
6		<p>Screw on cap nut</p>
7		<p>Apply installation torque <math>T_{inst}</math>.</p>

Wedge Anchor BZ3 / BZ3 A4 / BZ3 HCR

Intended use  
Installation instructions with cap nut

Annex B6

## Installation instructions with filling of annular gap

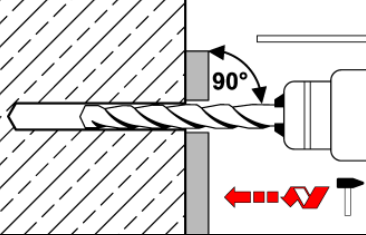
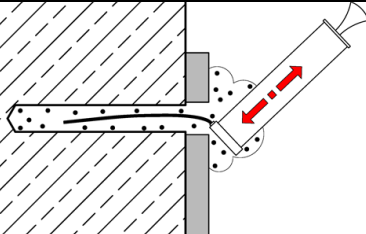
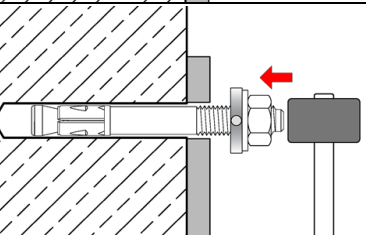
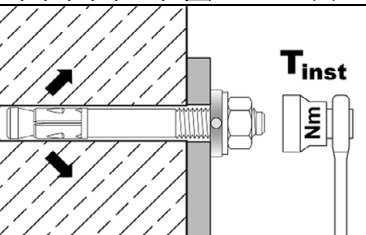
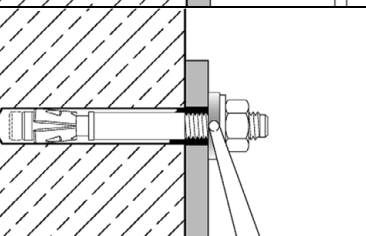
1		<p>Drill hole perpendicular to concrete surface. If using a vacuum drill bit, proceed with step 3.</p>
2		<p>Blow out dust. Alternatively vacuum clean down to the bottom of the hole.</p>
3		<p>Drive in fastener with additionally mounted filling washer.</p>
4		<p>Apply installation torque <math>T_{inst}</math>.</p>
5		<p>Fill the annular gap between anchor and fixture with injection adhesive (see Annex B1). Use enclosed reducing adapter. The annular gap is completely filled, when excess mortar seeps out.</p>

**Wedge Anchor BZ3 / BZ3 A4 / BZ3 HCR**

**Intended use**  
Installation instructions with filling of annular gap

**Annex B7**



**Table C1: Characteristic values for tension loads** under static and quasi-static action, **BZ3** (steel, zinc plated)

Fastener size			BZ3			
			M8	M10	M12	M16
Installation factor	$\gamma_{inst}$	[-]	1,0			
<b>Steel failure</b>						
Characteristic resistance	$N_{Rk,s}$	[kN]	19,8	30,4	44,9	79,3
Partial factor <sup>4)</sup>	$\gamma_{Ms}$	[-]	1,5			
<b>Pull-out</b>						
Characteristic resistance in cracked concrete C20/25	$N_{Rk,p,cr}$	[kN]	9,5	15	22	30
Increasing factor $N_{Rk,p,cr} = \psi_C \cdot N_{Rk,p,cr} (C20/25)$	$\psi_C$	[-]	$\left(\frac{f_{ck}}{20}\right)^{0,439}$	$\left(\frac{f_{ck}}{20}\right)^{0,265}$	$\left(\frac{f_{ck}}{20}\right)^{0,5}$	$\left(\frac{f_{ck}}{20}\right)^{0,339}$
Characteristic resistance in uncracked concrete C20/25	$N_{Rk,p,ucr}$	[kN]	14	24	30	50
Increasing factor $N_{Rk,p,ucr} = \psi_C \cdot N_{Rk,p,ucr} (C20/25)$	$\psi_C$	[-]	$\left(\frac{f_{ck}}{20}\right)^{0,489}$	$\left(\frac{f_{ck}}{20}\right)^{0,448}$	$\left(\frac{f_{ck}}{20}\right)^{0,5}$	$\left(\frac{f_{ck}}{20}\right)^{0,203}$
<b>Splitting</b>						
Characteristic resistance	$N^0_{Rk,sp}$	[kN]	$\min ( N_{Rk,p} ; N^0_{Rk,c} )^3$			
Characteristic edge distance <sup>2)</sup>	$C_{cr,sp}$	[mm]	$\frac{A_{sp} + 0,8 \cdot (h_{sp} - h_{ef})^2}{(3,41 \cdot h_{sp} - 0,59 \cdot h_{ef})}$			
Characteristic spacing	$S_{cr,sp}$	[mm]	$2 \cdot C_{cr,sp}$			
<b>Concrete cone failure</b>						
Minimum, effective anchorage depth	$h_{ef,min}$	[mm]	35 <sup>1)</sup>	40	50	65
Maximum, effective anchorage depth	$h_{ef,max}$	[mm]	90	100	125	160
Characteristic edge distance	$C_{cr,N}$	[mm]	$1,5 \cdot h_{ef}$			
Characteristic spacing	$S_{cr,N}$	[mm]	$2 \cdot C_{cr,N}$			
Factor	cracked concrete	$k_{cr,N}$	7,7			
	uncracked concrete	$k_{ucr,N}$	11,0			

<sup>1)</sup> Fastenings with anchorage depth  $h_{ef} < 40$ mm are restricted to the use of structural components which are statically indeterminate and subject to internal exposure conditions only.

<sup>2)</sup> Applicable concrete thickness  $h_{sp}$  and area  $A_{sp}$  to determine characteristic edge distance  $C_{cr,sp}$  according to Table B3

<sup>3)</sup>  $N^0_{Rk,c}$  according to EN 1992-4:2018

<sup>4)</sup> In absence of other national regulations

**Wedge Anchor BZ3 / BZ3 A4 / BZ3 HCR**

**Annex C1**

**Performance**

Characteristic values for **tension loads, BZ3** (Steel, zinc plated)

**Table C2:** Characteristic values for **tension loads** under static or quasi-static action, **BZ3 A4** and **BZ3 HCR**

Fastener size			BZ3 A4 / BZ3 HCR			
			M8	M10	M12	M16
Installation factor	$\gamma_{inst}$	[-]	1,0			
<b>Steel failure</b>						
Characteristic resistance	$N_{Rk,s}$	[kN]	19,8	30,4	44,9	74,6
Partial factor <sup>4)</sup>	$\gamma_{Ms}$	[-]	1,5			
<b>Pull-out</b>						
Characteristic resistance in cracked concrete C20/25	$N_{Rk,p,cr}$	[kN]	9,5	17	22	35
Increasing factor $N_{Rk,p,cr} = \psi_C \cdot N_{Rk,p,cr}$ (C20/25)	$\psi_C$	[-]	$\left(\frac{f_{ck}}{20}\right)^{0,488}$	$\left(\frac{f_{ck}}{20}\right)^{0,5}$	$\left(\frac{f_{ck}}{20}\right)^{0,435}$	$\left(\frac{f_{ck}}{20}\right)^{0,350}$
Characteristic resistance in uncracked concrete C20/25	$N_{Rk,p,ucr}$	[kN]	20	25	42	50
Increasing factor $N_{Rk,p,ucr} = \psi_C \cdot N_{Rk,p,ucr}$ (C20/25)	$\psi_C$	[-]	$\left(\frac{f_{ck}}{20}\right)^{0,240}$	$\left(\frac{f_{ck}}{20}\right)^{0,364}$	$\left(\frac{f_{ck}}{20}\right)^{0,213}$	$\left(\frac{f_{ck}}{20}\right)^{0,196}$
<b>Splitting</b>						
Characteristic resistance	$N^0_{Rk,sp}$	[kN]	$\min ( N_{Rk,p} ; N^0_{Rk,c}{}^3 )$			
Characteristic edge distance <sup>2)</sup>	$C_{cr,sp}$	[mm]	$\frac{A_{sp} + 0,8 \cdot (h_{sp} - h_{ef})^2}{(3,41 \cdot h_{sp} - 0,59 \cdot h_{ef})}$			
Characteristic spacing	$S_{cr,sp}$	[mm]	$2 \cdot C_{cr,sp}$			
<b>Concrete cone failure</b>						
Minimum, effective anchorage depth	$h_{ef,min}$	[mm]	35 <sup>1)</sup>	40	50	65
Maximum, effective anchorage depth	$h_{ef,max}$	[mm]	90	100	125	160
Characteristic edge distance	$C_{cr,N}$	[mm]	$1,5 \cdot h_{ef}$			
Characteristic spacing	$S_{cr,N}$	[mm]	$2 \cdot C_{cr,N}$			
Factor	cracked concrete	$k_{cr,N}$	7,7			
	uncracked concrete	$k_{ucr,N}$	11,0			

1) Fastenings with anchorage depth  $h_{ef} < 40$  mm are restricted to the use of structural components which are statically indeterminate and subject to internal exposure conditions only

2) Applicable concrete thickness  $h_{sp}$  and area  $A_{sp}$  according to Table B3 to determine characteristic edge distance  $C_{cr,sp}$

3)  $N^0_{Rk,c}$  according to EN 1992-4:2018

4) In absence of other national regulations

**Wedge Anchor BZ3 / BZ3 A4 / BZ3 HCR**

**Performance**  
Characteristic values for **tension loads, BZ3 A4** and **BZ3 HCR**

**Annex C2**

**Table C3:** Characteristic values for **shear loads** under static and quasi-static action

Fastener size				BZ3 / BZ3 A4 / BZ3 HCR			
				M8	M10	M12	M16
Installation factor	$\gamma_{inst}$	[-]	1,0				
<b>Steel failure <u>without</u> lever arm</b>							
Characteristic resistance	BZ3	$V_{RK,s}^0$	[kN]	15,7	26,8	38,3	60,0
	BZ3 A4 / HCR	$V_{RK,s}^0$	[kN]	16,8	27,8	39,8	69,5
Partial factor <sup>2)</sup>	$\gamma_{Ms}$	[-]	1,25				
Ductility factor	$k_7$	[-]	1,0				
<b>Steel failure <u>with</u> lever arm</b>							
Characteristic bending resistance	BZ3	$M_{RK,s}^0$	[Nm]	30	60	105	240
	BZ3 A4 / HCR	$M_{RK,s}^0$	[Nm]	27	55	99	223
Partial factor <sup>2)</sup>	$\gamma_{Ms}$	[-]	1,25				
<b>Concrete pry-out failure</b>							
Pry-out factor	BZ3	$k_8$	[-]	2,8	3,1	3,0	3,6
	BZ3 A4 / HCR	$k_8$	[-]	2,7	2,8	3,3	3,4
<b>Concrete edge failure</b>							
Effective length of fastener in shear loading	$l_f$	[mm]	$h_{ef}^{1)}$				
Outside diameter of fastener	$d_{nom}$	[mm]	8	10	12	16	

<sup>1)</sup> Fastenings with anchorage depth  $h_{ef} < 40$  mm are restricted to the use of structural components which are statically indeterminate and subject to internal exposure conditions only.

<sup>2)</sup> In absence of other national regulations

**Wedge Anchor BZ3 / BZ3 A4 / BZ3 HCR**

**Performance**  
Characteristic values for **shear loads**

**Annex C3**

**Table C4: Characteristic values for seismic loading, performance category C1**

Fastener size				BZ3 / BZ3 A4 / BZ3 HCR							
				M8		M10		M12		M16	
Effective anchorage depth	$h_{ef} \geq$	[mm]		40	45	40	60	50	70	65	85
<b>Tension load</b>											
Installation factor	$\gamma_{inst}$	[-]		1,0							
<b>Steel failure</b>											
Characteristic resistance	BZ3	$N_{Rk,s,C1}$	[kN]	19,8		30,4		44,9		79,3	
	BZ3 A4 / HCR	$N_{Rk,s,C1}$	[kN]	19,8		30,4		44,9		74,6	
<b>Pull-out</b>											
Characteristic resistance	BZ3	$N_{Rk,p,C1}$	[kN]	9,1		15,0		22,0		30,0	
	BZ3 A4 / HCR	$N_{Rk,p,C1}$	[kN]	9,0		17,0		22,0		35,0	
<b>Shear load</b>											
<b>Steel failure without lever arm</b>											
Characteristic resistance	BZ3	$V_{Rk,s,C1}$	[kN]	11,7	13,4	22,5	24,4	30,0	33,8	48,8	52,3
	BZ3 A4 / HCR	$V_{Rk,s,C1}$	[kN]	11,0	12,7	20,6	22,2	33,2	33,2	61,1	64,3
Factor for anchorages	with annular gap	$\alpha_{gap}$	[-]	0,5							
	without annular gap	$\alpha_{gap}$	[-]	1,0							

**Table C5: Characteristic values for seismic loading, performance category C2**

Fastener size				BZ3 / BZ3 A4 / BZ3 HCR							
				M8		M10		M12		M16	
Effective anchorage depth	$h_{ef} \geq$	[mm]		40	45	40	60	50	70	65	85
<b>Tension load</b>											
Installation factor	$\gamma_{inst}$	[-]		1,0							
<b>Steel failure</b>											
Characteristic resistance	BZ3	$N_{Rk,s,C2}$	[kN]	19,8		30,4		44,9		79,3	
	BZ3 A4 / HCR	$N_{Rk,s,C2}$	[kN]	19,8		30,4		44,9		74,6	
<b>Pull-out</b>											
Characteristic resistance	BZ3	$N_{Rk,p,C2}$	[kN]	2,8	3,6	7,3	12,5	10,7	19,0	19,8	35,2
	BZ3 A4 / HCR	$N_{Rk,p,C2}$	[kN]	2,3	3,2	5,0	7,7	8,0	13,8	19,0	29,4
<b>Shear load</b>											
<b>Steel failure without lever arm</b>											
Characteristic resistance	BZ3	$V_{Rk,s,C2}$	[kN]	7,3	11,3	15,4	19,0	18,3	28,0	39,4	43,3
	BZ3 A4 / HCR	$V_{Rk,s,C2}$	[kN]	7,5	8,6	12,5	15,9	22,4	25,6	42,7	46,1
Factor for anchorages	with annular gap	$\alpha_{gap}$	[-]	0,5							
	without annular gap	$\alpha_{gap}$	[-]	1,0							

**Wedge Anchor BZ3 / BZ3 A4 / BZ3 HCR**

**Performance**  
Characteristic resistance for **seismic loading**

**Annex C4**

**Table C6:** Characteristic values for tension and shear load under fire exposure, BZ3 (steel, zinc plated)

Fastener size				BZ3			
				M8	M10	M12	M16
<b>Tension load</b>							
<b>Steel failure</b>							
Characteristic resistance	R30	$N_{Rk,s,fi}$	[kN]	1,2	2,6	4,6	7,7
	R60			1,0	1,9	3,3	5,6
	R90			0,7	1,3	2,1	3,5
	R120			0,6	1,0	1,5	2,5
<b>Shear load</b>							
<b>Steel failure <u>without</u> lever arm</b>							
Characteristic resistance	R30	$V_{Rk,s,fi}$	[kN]	4,0	7,5	12,3	20,7
	R60			2,7	5,1	8,5	14,2
	R90			1,4	2,7	4,6	7,7
	R120			0,8	1,6	2,7	4,5
<b>Steel failure <u>with</u> lever arm</b>							
Characteristic resistance	R30	$M^0_{Rk,s,fi}$	[Nm]	4,1	9,6	19,1	43,8
	R60			2,8	6,6	13,1	30,1
	R90			1,5	3,5	7,2	16,4
	R120			0,8	2,0	4,2	9,6

$N_{Rk,p,fi}$  and  $N_{Rk,c,fi}$  according to EN 1992-4:2018

**Wedge Anchor BZ3 / BZ3 A4 / BZ3 HCR**

**Performance**  
Characteristic values under **fire exposure, BZ3** (steel, zinc plated)

**Annex C5**

**Table C7: Characteristic values for tension and shear load under fire exposure, BZ3 A4 and BZ3 HCR**

Fastener size				BZ3 A4 / BZ3 HCR			
				M8	M10	M12	M16
<b>Tension load</b>							
<b>Steel failure</b>							
Characteristic resistance	R30	$N_{Rk,s,fi}$	[kN]	4,0	6,9	11,0	18,1
	R60			2,9	5,0	8,0	13,1
	R90			1,8	3,1	4,9	8,1
	R120			1,2	2,1	3,4	5,6
<b>Shear load</b>							
<b>Steel failure <u>without</u> lever arm</b>							
Characteristic resistance	R30	$V_{Rk,s,fi}$	[kN]	8,5	17,6	32,0	52,6
	R60			6,2	12,6	22,6	37,1
	R90			3,9	7,5	13,1	21,5
	R120			2,8	5,0	8,4	13,8
<b>Steel failure <u>with</u> lever arm</b>							
Characteristic resistance	R30	$M^0_{Rk,s,fi}$	[Nm]	8,7	22,7	49,8	111,5
	R60			6,3	16,2	35,1	78,6
	R90			4,0	9,7	20,4	45,6
	R120			2,8	6,5	13,0	29,2

$N_{Rk,p,fi}$  and  $N_{Rk,c,fi}$  according to EN 1992-4:2018

<b>Wedge Anchor BZ3 / BZ3 A4 / BZ3 HCR</b>	<b>Annex C6</b>
<b>Performance</b> Characteristic values under <b>fire exposure, BZ3 A4 and BZ3 HCR</b>	

**Table C8: Displacements under tension load, BZ3 (steel, zinc plated)**

Fastener size			BZ3							
			M8		M10		M12		M16	
<b>Displacements under static or quasi-static action</b>										
$\delta_{N0} = \delta_{N0\text{-factor}} \cdot N$			N: acting tension load							
$\delta_{N\infty} = \delta_{N\infty\text{-factor}} \cdot N$										
Effective anchorage depth	$h_{ef} \geq$	[mm]	35		40		50		65	
<b>Cracked concrete</b>										
Factor for displacement	$\delta_{N0\text{-factor}}$	[mm/kN]	0,13		0,05		0,04		0,03	
	$\delta_{N\infty\text{-factor}}$	[mm/kN]	0,29		0,20		0,15		0,11	
<b>Uncracked concrete</b>										
Factor for displacement	$\delta_{N0\text{-factor}}$	[mm/kN]	0,03		0,01		0,004		0,005	
	$\delta_{N\infty\text{-factor}}$	[mm/kN]	0,03		0,03		0,03		0,03	
<b>Displacement under seismic action C2</b>										
Effective anchorage depth	$h_{ef} \geq$	[mm]	40	45	40	60	50	70	65	85
Displacements for DLS	$\delta_{N, C2(DLS)}$	[mm]	3,9	4,9	2,8	4,7	2,4	4,2	2,5	4,5
Displacements for ULS	$\delta_{N, C2(ULS)}$	[mm]	11,3	14,3	9,4	16,1	7,3	12,9	7,2	12,8

**Table C9: Displacements under tension load, BZ3 A4 and BZ3 HCR**

Fastener size			BZ3 A4 / BZ3 HCR							
			M8		M10		M12		M16	
<b>Displacements under static or quasi-static action</b>										
$\delta_{N0} = \delta_{N0\text{-factor}} \cdot N$			N: acting tension load							
$\delta_{N\infty} = \delta_{N\infty\text{-factor}} \cdot N$										
Effective anchorage depth	$h_{ef} \geq$	[mm]	35		40		50		65	
<b>Cracked concrete</b>										
Factor for displacement	$\delta_{N0\text{-factor}}$	[mm/kN]	0,11		0,06		0,05		0,02	
	$\delta_{N\infty\text{-factor}}$	[mm/kN]	0,27		0,17		0,16		0,08	
<b>Uncracked concrete</b>										
Factor for displacement	$\delta_{N0\text{-factor}}$	[mm/kN]	0,02		0,00		0,001		0,00	
	$\delta_{N\infty\text{-factor}}$	[mm/kN]	0,05		0,05		0,05		0,05	
<b>Displacement under seismic action C2</b>										
Effective anchorage depth	$h_{ef} \geq$	[mm]	40	45	40	60	50	70	65	85
Displacements for DLS	$\delta_{N, C2(DLS)}$	[mm]	2,0	2,9	2,6	4,1	3,3	5,7	3,3	5,1
Displacements for ULS	$\delta_{N, C2(ULS)}$	[mm]	7,7	11,1	10,8	16,8	10,4	18,0	9,0	13,9

**Wedge Anchor BZ3 / BZ3 A4 / BZ3 HCR**

**Performance**  
Displacements under tension load

**Annex C7**

**Table C10: Displacements under shear load, BZ3 (steel, zinc plated)**

Fastener size			BZ3							
			M8	M10	M12	M16				
<b>Displacements under static or quasi-static action</b>										
$\delta_{V0} = \delta_{V0\text{-factor}} \cdot V$			V: acting shear load							
$\delta_{V\infty} = \delta_{V\infty\text{-factor}} \cdot V$										
Effective anchorage depth	$h_{ef} \geq$	[mm]	35	40	50	65				
Factor for displacement	$\delta_{V0\text{-factor}}$	[mm/kN]	0,15	0,09	0,09	0,07				
	$\delta_{V\infty\text{-factor}}$	[mm/kN]	0,22	0,13	0,14	0,11				
<b>Displacement under seismic action C2 <sup>1)</sup></b>										
Effective anchorage depth	$h_{ef} \geq$	[mm]	40	45	40	60	50	70	65	85
Displacements for DLS	$\delta_{V,C2(DLS)}$	[mm]	2,8	2,7	3,0	3,1	3,4	3,7	3,4	3,8
Displacements for ULS	$\delta_{V,C2(ULS)}$	[mm]	5,1	5,0	5,0	5,5	6,3	9,9	6,0	9,6

<sup>1)</sup> For anchorages with clearance in the fixture the annular gap must also be taken into account.

**Table C11: Displacements under shear load, BZ3 A4 and BZ3 HCR**

Fastener size			BZ3 A4 / BZ3 HCR							
			M8	M10	M12	M16				
<b>Displacements under static or quasi-static action</b>										
$\delta_{V0} = \delta_{V0\text{-factor}} \cdot V$			V: acting shear load							
$\delta_{V\infty} = \delta_{V\infty\text{-factor}} \cdot V$										
Effective anchorage depth	$h_{ef} \geq$	[mm]	35	40	50	65				
Factor for displacement	$\delta_{V0\text{-factor}}$	[mm/kN]	0,26	0,14	0,12	0,09				
	$\delta_{V\infty\text{-factor}}$	[mm/kN]	0,39	0,20	0,17	0,14				
<b>Displacement under seismic action C2 <sup>1)</sup></b>										
Effective anchorage depth	$h_{ef} \geq$	[mm]	40	45	40	60	50	70	65	85
Displacements for DLS	$\delta_{V,C2(DLS)}$	[mm]	2,8	3,0	3,4	3,5	3,5	4,2	3,8	4,4
Displacements for ULS	$\delta_{V,C2(ULS)}$	[mm]	5,2	5,1	7,0	8,4	7,5	11,8	7,8	11,1

<sup>1)</sup> For anchorages with clearance in the fixture the annular gap must also be taken into account

<b>Wedge Anchor BZ3 / BZ3 A4 / BZ3 HCR</b>	<b>Annex C8</b>
<b>Performance</b> Displacements under tension load	