

VYHLÁSENIE O PARAMETROCH

DoP č.: MKT-1.4-100_sk

- ✧ **Jedinečný identifikačný kód typu výrobku:** **Wedge kotva BZ3 dynamic**
- ✧ **Zamýšľané použitie/použitia:** Mechanická hmoždinka na použitie v betóne, vid' príloha / Annex B
- ✧ **Výrobca:** MKT Metall-Kunststoff-Technik GmbH & Co.KG
Auf dem Immel 2
67685 Weilerbach
- ✧ **Systém(-y) posudzovania a overovania nemennosti parametrov:** 1
- ✧ **Európsky hodnotiaci dokument:** **EAD 330250-00-0601**
Európske technické posúdenie: **ETA-20/0117, 19.06.2020**
Orgán technického posudzovania: DIBt, Berlin
Notifikovaný(-é) subjekt(-y): NB 2873 – Technische Universität Darmstadt

✧ **Deklarované parametre:**

Podstatné vlastnosti (Metóda oceňovania B)	Parametre
Mechanická odolnosť a stabilita (BWR 1)	
Charakteristická únavu pri cyklickom namáhaní v ťahu	Príloha/Annex C1
Charakteristická únavová odolnosť pri cyklickom priečnom zaťažení	
Charakteristická únavová odolnosť pri kombinovanom cyklickom ťahovom a priečnom zaťažení	
Faktor prenosu zaťaženia pre cyklické ťahové a priečne zaťaženie	

Uvedené parametre výrobku sú v zhode so súborom deklarovateľných parametrov. Toto vyhlásenie o parametroch sa v súlade s nariadením (EÚ) č. 305/2011 vydáva na výhradnú zodpovednosť uvedeného výrobcu.

Podpísal(-a) za a v mene výrobcu:



Stefan Weustenhagen
(Generálny riaditeľ)
Weilerbach, 01.01.2021

p.p. 
Dipl.-Ing. Detlef Bigalke
(Vedúci vývoja produktov)



Originál tohto vyhlásenia o vykonaní bol napísaný v nemčine. V prípade odchýlok v preklade platí nemecká verzia.

Specifications of intended use

Anchorage subject to:

- Fatigue cyclic loading
- Static and quasi-static action, fire exposure and seismic performance according to ETA-19/0619

Base materials:

- Cracked or uncracked concrete
- Compacted, reinforced or unreinforced normal weight concrete without fibres according to EN 206: 2013+A1:2016
- Strength classes C20/25 to C50/60 according to EN 206:2013+A1:2016

Use conditions (Environmental conditions):

- Structures subject to dry internal conditions

Design:

- Anchorages are designed under the responsibility of an engineer experienced in anchorages and concrete work.
- Verifiable calculation notes and drawings are prepared taking account of the loads to be anchored. The position of the fastener is indicated on the design drawings (e.g. position of the fastener relative to reinforcement or to supports, etc.).
- Design method EN 1992-4:2018 and TR 061 (design method II)

Installation:

- Hole drilling by hammer drill bit or vacuum drill bit
- Use of the fastener only as supplied by the manufacturer without exchanging the components of the fastener

Wedge Anchor BZ3 dynamic

Intended use
Specifications of intended use

Annex B1

Table B1: Installation parameters

Anchor size		M10	M12	M16
Nominal drill hole diameter	$d_0 =$ [mm]	10	12	16
Cutting diameter of drill bit	$d_{cut} \leq$ [mm]	10,45	12,5	16,5
Effective anchorage depth ¹⁾	$h_{ef} \geq$ [mm]	60	70	85
Depth of drill hole	$h_0 \geq$ [mm]	$h_{ef} + 9$	$h_{ef} + 10$	$h_{ef} + 14$
	$h_1 \geq$ [mm]	$h_{ef} + 11$	$h_{ef} + 13$	$h_{ef} + 17$
Diameter of clearance hole in the fixture	$d_f =$ [mm]	12	14	18
Minimum fixture thickness	$t_{fix, min} =$ [mm]	5	6	8
Installation torque	$T_{inst} =$ [Nm]	40	60	110
Overstand	$h_p \leq$ [mm]	$21,5 + t_{fix}$	$25,5 + t_{fix}$	$29,5 + t_{fix}$
Length of fastener	L [mm]	$h_{ef} + t_{fix} + 30,5$	$h_{ef} + t_{fix} + 35,5$	$h_{ef} + t_{fix} + 43$
Hexagon nut	width across nut SW [mm]	17	19	24
Locknut	width across nut SW [mm]	17	19	24

¹⁾ End of thread must be above the concrete surface

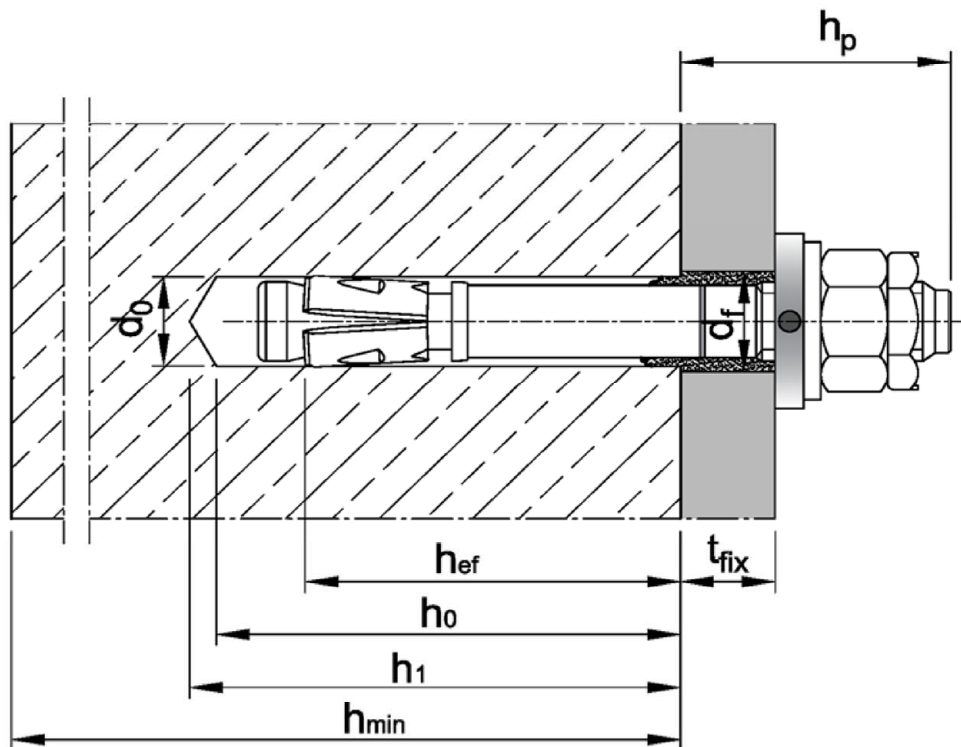

Wedge Anchor BZ3 dynamic

Intended use
Installation parameters

Annex B2

Table B2: Minimum thickness of concrete member, minimum spacings, edge distances and required area

Anchor size			M10	M12	M16	
Minimum member thickness depending on h_{ef}	$h_{min} \geq$	[mm]	1,5 · h_{ef}			
Minimum edge distances and spacings						
Minimum edge distance	c_{min}	[mm]	45	55	65	
Minimum spacings	s_{min}	[mm]	40	50	65	
Projected required area $A_{pr,req}$						
Projected required area	cracked concrete	$A_{pr,req}$	[mm ²]	23 700	31 500	42 300
	uncracked concrete	$A_{pr,req}$	[mm ²]	34 700	41 300	50 200
<p>The edge distances and spacings shall be selected in steps of 5 mm. In combination with variable anchorage depths and member thicknesses, the following equation must be fulfilled:</p>						
$A_{pr,req} \leq A_{pr,ef}$			$A_{pr,req}$	Projected required area		
			$A_{pr,ef}$	Projected effective area (acc. to Table B4)		

Table B3: Applicable concrete thickness h_{sp} and area A_{sp} to determine characteristic edge distance $c_{cr,sp}$

Anchor size			M10	M12	M16
Applicable concrete thickness	h_{sp}	[mm]	$\min(h; h_{ef} + 1,5 \cdot c \cdot \sqrt{2})$		
Area to determine $c_{cr,sp}$ ¹⁾	A_{sp}	[mm ²]	$\frac{N_{Rk,sp}^0 + 2,040}{0,000693}$	$\frac{N_{Rk,sp}^0 + 3,685}{0,000692}$	$\frac{N_{Rk,sp}^0 + 3,738}{0,000875}$

¹⁾ with $N_{Rk,sp}^0$ in kN according to ETA-19/0619

Wedge Anchor BZ3 dynamic	Annex B3
Intended use Minimum spacings and edge distances Required area and applicable concrete thickness	

Table B4: Projected effective area $A_{pr,ef}$ to determine spacings and edge distances

Member thickness: $h > h_{ef} + 1,5 \cdot c$			
Effective anchorage depth $h_{ef} < 1,5 \cdot c$		Effective anchorage depth $h_{ef} \geq 1,5 \cdot c$	
Anchor group with $s \geq 3 \cdot c$ or single anchor			
$A_{pr,ef} = 2 \cdot (3 \cdot c) \cdot (1,5 \cdot c + h_{ef})$ [mm ²]		$A_{pr,ef} = 2 \cdot (3 \cdot c) \cdot (3 \cdot c)$ [mm ²]	
Anchor group ($s < 3 \cdot c$)			
$A_{pr,ef} = (3 \cdot c + s) \cdot (1,5 \cdot c + h_{ef})$ [mm ²]		$A_{pr,ef} = (3 \cdot c + s) \cdot (3 \cdot c)$ [mm ²]	
Member thickness: $h \leq h_{ef} + 1,5 \cdot c$			
Effective anchorage depth $h_{ef} \leq 1,5 \cdot c$		Effective anchorage depth $h_{ef} > 1,5 \cdot c$	
Anchor group with $s \geq 3 \cdot c$ or single anchor			
$A_{pr,ef} = 2 \cdot (3 \cdot c) \cdot h$ [mm ²]		$A_{pr,ef} = 2 \cdot (3 \cdot c) \cdot (h - h_{ef} + 1,5 \cdot c)$ [mm ²]	
Anchor group ($s < 3 \cdot c$)			
$A_{pr,ef} = (3 \cdot c + s) \cdot h$ [mm ²]		$A_{pr,ef} = (3 \cdot c + s) \cdot (h - h_{ef} + 1,5 \cdot c)$ [mm ²]	
<p>If the area $A_{pr,ef}$ is trimmed by lateral edges ($c_2 < 1,5 \cdot c$), calculate the area actually present. The spacings and edge distances shall be rounded to 5 mm.</p>			

Wedge Anchor BZ3 dynamic

Intended use
Projected effective area to determine spacings and edge distances

Annex B4

Installation instructions

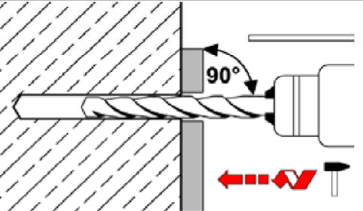
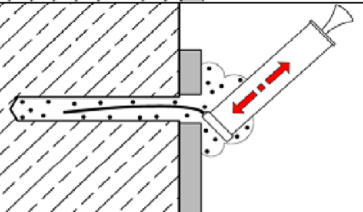
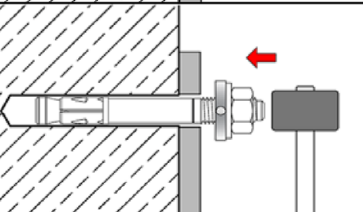
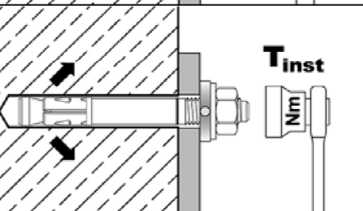
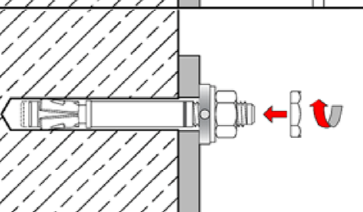
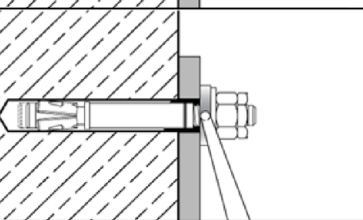
1		<p>Drill hole perpendicular to concrete surface. If using a vacuum drill bit, proceed with step 3.</p>
2		<p>Blow out dust. Alternatively vacuum clean down to the bottom of the hole.</p>
3		<p>Drive in fastener with filling washer until effective anchorage depth is reached.</p>
4		<p>Apply installation torque T_{inst} according to Table B1 by using torque wrench.</p>
5		<p>Screw on locknut until hand tight then tighten $\frac{1}{4}$ to $\frac{1}{2}$ turn.</p>
6		<p>Fill the annular gap between anchor and fixture with mortar (compressive strength $\geq 40 \text{ N/mm}^2$, e.g. MKT Injection System VMH, VMZ or VMU plus). Use enclosed reducing adapter. Observe the processing information of the mortar! The annular gap is completely filled, when excess mortar seeps out.</p>

Wedge Anchor BZ3 dynamic

Intended use
Installation instructions

Annex B5

Table C1: Characteristic values of fatigue resistance

Anchor size			M10	M12	M16
Tension load					
Steel failure					
Characteristic fatigue resistance	$\Delta N_{Rk,s,0,\infty}$	[kN]	4,6	6,2	9,7
Exponent for combined loading	α_s	[-]	0,5	0,5	0,7
Load-transfer factor for fastener groups	ψ_{FN}	[-]	0,5		
Pull-out					
Characteristic fatigue resistance	$\Delta N_{Rk,p,0,\infty}$	[kN]	0,5 $N_{Rk,p}$ ¹⁾		
Concrete cone and splitting failure					
Characteristic fatigue resistance	$\Delta N_{Rk,c,0,\infty}$	[kN]	0,5 $N_{Rk,c}$ ¹⁾		
	$\Delta N_{Rk,sp,0,\infty}$	[kN]	0,5 $N_{Rk,sp}$ ¹⁾		
Effective anchorage depth	$h_{ef} \geq$	[mm]	60	70	85
Shear load					
Steel failure without lever arm					
Characteristic fatigue resistance	$\Delta V_{Rk,s,0,\infty}$	[kN]	2,5	4,0	7,5
Exponent for combined loading	α_s	[-]	0,5	0,5	0,7
Load-transfer factor for fastener groups	ψ_{FV}	[-]	0,5		
Concrete pry-out failure					
Characteristic fatigue resistance	$\Delta V_{Rk,cp,0,\infty}$	[kN]	0,5 $V_{Rk,cp}$ ¹⁾		
Concrete edge failure					
Characteristic fatigue resistance	$\Delta V_{Rk,c,0,\infty}$	[kN]	0,5 $V_{Rk,c}$ ¹⁾		
Effective length of anchor	l_f	[mm]	60	70	85
Diameter of anchor	d_{nom}	[mm]	10	12	16

¹⁾ $N_{Rk,c}$, $N_{Rk,p}$, $N_{Rk,sp}$, $V_{Rk,c}$ and $V_{Rk,cp}$ – Characteristic values of resistance under static or quasi-static actions according to ETA-19/0619 and EN 1992-4:2018

Wedge Anchor BZ3 dynamic

Performance
Characteristic values of fatigue resistance

Annex C1