

ДЕКЛАРАЦИЯ ЗА ЕКСПЛОАТАЦИОННИ ПОКАЗАТЕЛИ

DoP № MKT-1.4-101_bg

- ❖ **Уникален идентификационен код на типа продукт:** Болтова котва BZ3 dynamic
- ❖ **Предвидена употреба/употреби:** Постмонтирани крепежни елементи в бетон при циклично натоварване, свързано с умора, свързано с умората / Annex B
- ❖ **Производител:** MKT Metall-Kunststoff-Technik GmbH & Co.KG
Auf dem Immel 2
67685 Weilerbach
- ❖ **Система/системи за оценяване и проверка на постоянството на експлоатационните показатели:** 1
- ❖ **Европейски документ за оценяване:** EAD 330250-00-0601
Европейска техническа оценка: ETA-20/0117, 20.02.2023
Орган за техническа оценка: DIBt, Berlin
отифициран орган/органи: NB 2873 – Technische Universität Darmstadt

❖ **Декларираните експлоатационни показатели:**

Съществени характеристики	Експлоатационни показатели
Механично съпротивление и устойчивост (BWR 1)	
характерна якост на опън (статична и квази-статична)	Приложение/Annex B3, C2, C3
характерна напречна товароносимост (статична и квази-статична)	Приложение/Annex C4
Смени	Приложение/Annex C8, C9
Характерни съпротивления и измествания за сеизмичните категории на изпълнение C1 + C2	Приложение/Annex C5
трайност	Приложение/Annex B1
Характерна устойчивост на умора при циклично напрежение на опън	Приложение/Annex C1
Характерна устойчивост на умора при циклични напречни натоварвания	
Характерна устойчивост на умора при комбинирани циклични натоварвания и напречни натоварвания	
Коефициент на преразпределение на натоварването за цикличен опън и срязване и комбиниран опън и срязване	
Безопасност в случай на пожар (BWR 2)	
на поведение при пожар	Клас A1
пожароустойчивост	Приложение/Annex C6, C7

експлоатационните показатели на продукта, посочени по-горе, са в съответствие с декларираните експлоатационни показатели. Настоящата декларация за експлоатационни показатели се издава в съответствие с Регламент (ЕС) № 305/2011, като отговорността за нея се носи изцяло от посочения по-горе производител.

Подписано за и от името на производителя от:

Stefan Weustenhagen
(Управител)
Weilerbach, 20.02.2023

Dipl.-Ing. Detlef Bigalke
(Продуктов мениджър)



Оригиналът на тази декларация за изпълнение е на немски език. В случай на отклонения в превода, немската версия е валидна.

Specifications of intended use

Anchorage subject to:

- Fatigue cyclic loading
- Static and quasi-static action, fire exposure and seismic performance according to ETA-19/0619

Base materials:

- Cracked or uncracked concrete
- Compacted, reinforced or unreinforced normal weight concrete without fibres according to EN 206:2013+A1:2016
- Strength classes C20/25 to C50/60 according to EN 206:2013+A1:2016

Use conditions (Environmental conditions):

- Structures subject to dry internal conditions
- For all other conditions according to EN 1993-1-2006+A1:2015-10, corresponding to corrosion resistance classes CRC according to Annex A2, Table A2

Design:

- Anchorages are designed under the responsibility of an engineer experienced in anchorages and concrete work.
- Verifiable calculation notes and drawings are prepared taking account of the loads to be anchored. The position of the fastener is indicated on the design drawings (e.g. position of the fastener relative to reinforcement or to supports, etc.).
- Design method EN 1992-4:2018, TR 055:2018 and TR 061:2020 (design method II)

Installation:

- Hole drilling by hammer drill bit or vacuum drill bit
- Use of the fastener only as supplied by the manufacturer without exchanging the components of the fastener

Wedge Anchor BZ3 dynamic

Intended use
Specifications of intended use

Annex B1

Table B1: Installation parameters

Anchor size		M10	M12	M16
Nominal drill hole diameter	$d_0 =$ [mm]	10	12	16
Cutting diameter of drill bit	$d_{cut} \leq$ [mm]	10,45	12,5	16,5
Effective anchorage depth ¹⁾	$h_{ef} \geq$ [mm]	60	70	85
Depth of drill hole	$h_0 \geq$ [mm]	$h_{ef} + 9$	$h_{ef} + 10$	$h_{ef} + 14$
	$h_1 \geq$ [mm]	$h_{ef} + 11$	$h_{ef} + 13$	$h_{ef} + 17$
Diameter of clearance hole in the fixture	$d_f =$ [mm]	12	14	18
Minimum fixture thickness	$t_{fix,min} =$ [mm]	5	6	8
Installation torque	vz $T_{inst} =$ [Nm]	40	60	110
	A4 / HCR $T_{inst} =$ [Nm]	40	55	100
Overstand	$h_p \leq$ [mm]	$21,5 + t_{fix}$	$25,5 + t_{fix}$	$29,5 + t_{fix}$
Length of fastener	L [mm]	$h_{ef} + t_{fix} + 30,5$	$h_{ef} + t_{fix} + 35,5$	$h_{ef} + t_{fix} + 43$
Hexagon nut	width across nut [mm]	17	19	24
Locknut	width across nut [mm]	17	19	24

¹⁾ End of thread must be above the concrete surface

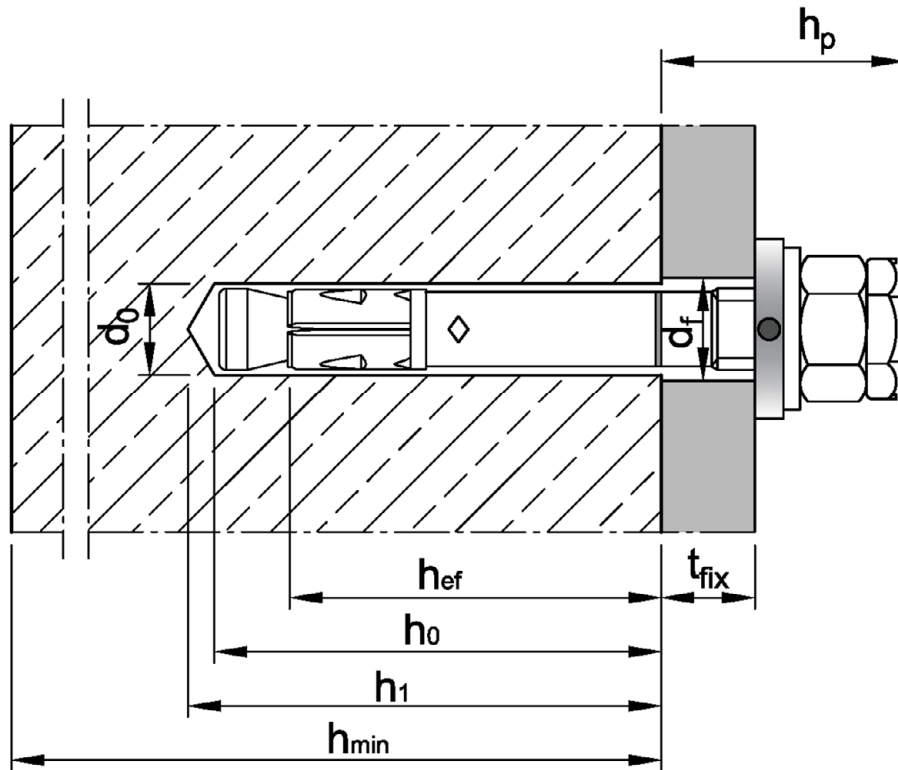

Wedge Anchor BZ3 dynamic

Intended use
Installation parameters

Annex B2

Table B2: Minimum thickness of concrete member, minimum spacings, edge distances and required area

Anchor size			M10	M12	M16
Minimum member thickness depending on h_{ef}	$h_{min} \geq$	[mm]	1,5 · h_{ef}		
Minimum edge distances and spacings					
Minimum edge distance	c_{min}	[mm]	45	55	65
	for $s \geq$	[mm]	see Table B4		
Minimum spacings	s_{min}	[mm]	40	50	65
	for $c \geq$	[mm]	see Table B4		
<p>The following equation must be fulfilled for the calculation of the minimum spacing and edge distance during installation in connection with the anchorage depth and the member thickness:</p> $A_{sp,rqd} \leq A_{sp,ef}$ <p>Required splitting area $A_{sp,rqd}$ and idealized splitting area $A_{sp,ef}$ acc. to Table B4.</p>					

Table B3: Applicable concrete thickness h_{sp} and area A_{sp} to determine characteristic edge distance $c_{cr,sp}$

Anchor size			M10	M12	M16
Applicable concrete thickness	h_{sp}	[mm]	$\min(h ; h_{ef} + 1,5 \cdot c \cdot \sqrt{2})$		
Area to determine $c_{cr,sp}$	VZ	A_{sp}	$\frac{N_{Rk,sp}^0 + 2,040}{0,000693}$	$\frac{N_{Rk,sp}^0 + 3,685}{0,000692}$	$\frac{N_{Rk,sp}^0 + 3,738}{0,000875}$
	A4 HCR	A_{sp}	$\frac{N_{Rk,sp}^0 + 7,235}{0,000967}$	$\frac{N_{Rk,sp}^0 + 7,847}{0,000951}$	$\frac{N_{Rk,sp}^0 + 11,415}{0,000742}$

Wedge Anchor BZ3 dynamic

Intended use

Minimum spacings and edge distances
Required area and applicable concrete thickness

Annex B3

Table B4: Areas to determine spacings and edge distances for installation

Anchor size		M10	M12	M16		
<p>The following equation must be fulfilled for the calculation of the minimum spacing and edge distance during installation in combination with variable anchorage depth and member thickness:</p> $A_{sp,rqd} \leq A_{sp,ef}$						
<p>Idealized splitting area $A_{sp,ef}$ The spacings and edge distances shall be selected or rounded in steps of 5 mm.</p>						
<p>Member thickness: $h > h_{ef} + 1,5 \cdot c$</p>						
<p>Single anchor or anchor group with $s \geq 3 \cdot c$</p>						
Effective anchorage depth	$h_{ef} < 1,5 \cdot c$	$A_{sp,ef} = (6 \cdot c) \cdot (1,5 \cdot c + h_{ef})$		[mm ²]		
Effective anchorage depth	$h_{ef} \geq 1,5 \cdot c$	$A_{sp,ef} = (6 \cdot c) \cdot (3 \cdot c)$		[mm ²]		
<p>Anchor group ($s < 3 \cdot c$)</p>						
Effective anchorage depth	$h_{ef} < 1,5 \cdot c$	$A_{sp,ef} = (3 \cdot c + s) \cdot (1,5 \cdot c + h_{ef})$		[mm ²]		
Effective anchorage depth	$h_{ef} \geq 1,5 \cdot c$	$A_{sp,ef} = (3 \cdot c + s) \cdot (3 \cdot c)$		[mm ²]		
<p>Member thickness: $h \leq h_{ef} + 1,5 \cdot c$</p>						
<p>Single anchor or anchor group with $s \geq 3 \cdot c$</p>						
Effective anchorage depth	$h_{ef} < 1,5 \cdot c$	$A_{sp,ef} = (6 \cdot c) \cdot h$		[mm ²]		
Effective anchorage depth	$h_{ef} \geq 1,5 \cdot c$	$A_{sp,ef} = (6 \cdot c) \cdot (h - h_{ef} + 1,5 \cdot c)$		[mm ²]		
<p>Anchor group ($s < 3 \cdot c$)</p>						
Effective anchorage depth	$h_{ef} < 1,5 \cdot c$	$A_{sp,ef} = (3 \cdot c + s) \cdot h$		[mm ²]		
Effective anchorage depth	$h_{ef} \geq 1,5 \cdot c$	$A_{sp,ef} = (3 \cdot c + s) \cdot (h - h_{ef} + 1,5 \cdot c)$		[mm ²]		
<p>Required splitting area $A_{sp,rqd}$</p>						
vz	cracked concrete	$A_{sp,rqd}$	[mm ²]	23 700	31 500	42 300
	uncracked concrete	$A_{sp,rqd}$	[mm ²]	34 700	41 300	50 200
A4 HCR	cracked concrete	$A_{sp,rqd}$	[mm ²]	25 900	29 800	44 300
	uncracked concrete	$A_{sp,rqd}$	[mm ²]	35 700	35 300	54 800

Wedge Anchor BZ3 dynamic

Intended use

Areas to determine spacings and edge distances

Annex B4

Installation instructions

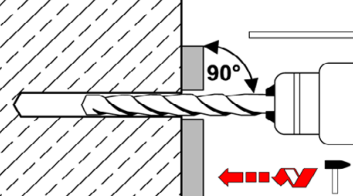
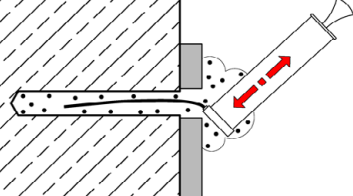
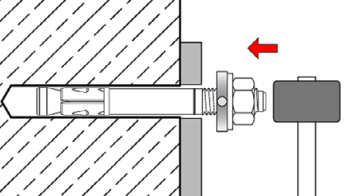
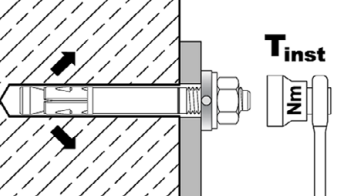
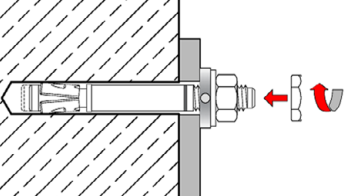
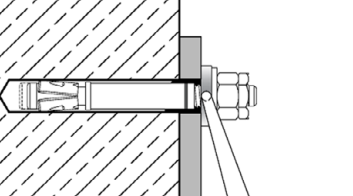
1		<p>Drill hole perpendicular to concrete surface. If using a vacuum drill bit, proceed with step 3.</p>
2		<p>Blow out dust. Alternatively, vacuum clean down to the bottom of the hole.</p>
3		<p>Drive in fastener with filling washer until effective anchorage depth is reached.</p>
4		<p>Apply installation torque T_{inst} according to Table B1 by using torque wrench.</p>
5		<p>Screw on locknut until hand tight then tighten $\frac{1}{4}$ to $\frac{1}{2}$ turn.</p>
6		<p>Fill the annular gap between anchor and fixture with mortar (compressive strength $\geq 40 \text{ N/mm}^2$, e.g. MKT Injection System VMH, VMZ or VMU plus). Use enclosed reducing adapter. Observe the processing information of the mortar! The annular gap is completely filled, when excess mortar seeps out.</p>

Wedge Anchor BZ3 dynamic

Intended use
Installation instructions

Annex B5

Table C1: Characteristic values of fatigue resistance

Anchor size				M10	M12	M16	
Tension load							
Steel failure							
Characteristic fatigue resistance	vZ	$\Delta N_{Rk,s,0,\infty}$	[kN]	4,6	6,2	9,7	
	A4		[kN]	3,2	5,3	9,2	
	HCR		[kN]	2,8	5,5	9,7	
Load-transfer factor for fastener groups			Ψ_{FN}	[-]			
Pull-out							
Characteristic fatigue resistance			$\Delta N_{Rk,p,0,\infty}$	[kN]	0,5 $N_{Rk,p}$		
Concrete cone and splitting failure							
Characteristic fatigue resistance	$\Delta N_{Rk,c,0,\infty}$		[kN]	0,5 $N_{Rk,c}$			
	$\Delta N_{Rk,sp,0,\infty}$		[kN]	0,5 $N_{Rk,sp}$			
Effective anchorage depth			h_{ef}	[mm]	60	70	85
Shear load							
Steel failure without lever arm							
Characteristic fatigue resistance	vZ	$\Delta V_{Rk,s,0,\infty}$	[kN]	2,5	4,0	7,5	
	A4		[kN]	1,5	2,8	6,0	
	HCR		[kN]	2,3	2,8	5,0	
Load-transfer factor for fastener groups			Ψ_{FV}	[-]			
Concrete pry-out failure							
Characteristic fatigue resistance			$\Delta V_{Rk,cp,0,\infty}$	[kN]	0,5 $V_{Rk,cp}$		
Concrete edge failure							
Characteristic fatigue resistance			$\Delta V_{Rk,c,0,\infty}$	[kN]	0,5 $V_{Rk,c}$		
Effective length of anchor			l_f	[mm]	60	70	85
Diameter of anchor			d_{nom}	[mm]	10	12	16
Tension and shear load							
Partial factor ¹⁾	$\gamma_{Ms,fat}$		[-]	1,35			
	$\gamma_{Mc,fat}$		[-]	1,5			
	$\gamma_{Msp,fat}$		[-]	1,5			
	$\gamma_{Mp,fat}$		[-]	1,5			
Exponents for combined loading	α_s		[-]	0,5	0,5	0,7	
	α_c		[-]	1,5			

¹⁾ In absence of other national regulations

Wedge Anchor BZ3 dynamic

Performance
Characteristic values of fatigue resistance

Annex C1

Table C2: Characteristic values for tension loads under static and quasi-static action, steel, zinc plated

Anchor size			M10	M12	M16
Installation factor	γ_{inst}	[-]	1,0		
Steel failure					
Characteristic resistance	$N_{Rk,s}$	[kN]	30,4	44,9	79,3
Partial factor ¹⁾	γ_{Ms}	[-]	1,5		
Pull-out					
Characteristic resistance in cracked concrete C20/25	$N_{Rk,p,cr}$	[kN]	15	22	30
Increasing factor $N_{Rk,p,cr} = \psi_C \cdot N_{Rk,p,cr} (C20/25)$	ψ_C	[-]	$\left(\frac{f_{ck}}{20}\right)^{0,265}$	$\left(\frac{f_{ck}}{20}\right)^{0,5}$	$\left(\frac{f_{ck}}{20}\right)^{0,339}$
Characteristic resistance in uncracked concrete C20/25	$N_{Rk,p,ucr}$	[kN]	24	30	50
Increasing factor $N_{Rk,p,ucr} = \psi_C \cdot N_{Rk,p,ucr} (C20/25)$	ψ_C	[-]	$\left(\frac{f_{ck}}{20}\right)^{0,448}$	$\left(\frac{f_{ck}}{20}\right)^{0,5}$	$\left(\frac{f_{ck}}{20}\right)^{0,203}$
Splitting					
Characteristic resistance	$N^0_{Rk,sp}$	[kN]	$\min(N_{Rk,p}; N^0_{Rk,c}{}^3)$		
Characteristic edge distance ²⁾	$C_{cr,sp}$	[mm]	$\frac{A_{sp} + 0,8 \cdot (h_{sp} - h_{ef})^2}{(3,41 \cdot h_{sp} - 0,59 \cdot h_{ef})}$		
Characteristic spacing	$S_{cr,sp}$	[mm]	$2 \cdot C_{cr,sp}$		
Concrete cone failure					
Effective anchorage depth	h_{ef}	[mm]	60	70	85
Characteristic edge distance	$C_{cr,N}$	[mm]	$1,5 \cdot h_{ef}$		
Characteristic spacing	$S_{cr,N}$	[mm]	$2 \cdot C_{cr,N}$		
Factor	cracked concrete	$k_{cr,N}$	7,7		
	uncracked concrete	$k_{ucr,N}$	11,0		

¹⁾ In absence of other national regulations

²⁾ Applicable concrete thickness h_{sp} and area A_{sp} to determine characteristic edge distance $C_{cr,sp}$ according to Table B3

³⁾ $N^0_{Rk,c}$ according to EN 1992-4:2018

Wedge Anchor BZ3 dynamic

Performance

Characteristic values for **tension loads, steel, zinc plated**

Annex C2

Table C3: Characteristic values for tension loads under static or quasi-static action, **A4** and **HCR**

Anchor size			M10	M12	M16
Installation factor	γ_{inst}	[-]	1,0		
Steel failure					
Characteristic resistance	$N_{RK,s}$	[kN]	30,4	44,9	74,6
Partial factor ¹⁾	γ_{Ms}	[-]	1,5		
Pull-out					
Characteristic resistance in cracked concrete C20/25	$N_{RK,p,cr}$	[kN]	17	22	35
Increasing factor $N_{RK,p,cr} = \psi_C \cdot N_{RK,p,cr} (C20/25)$	ψ_C	[-]	$\left(\frac{f_{ck}}{20}\right)^{0,5}$	$\left(\frac{f_{ck}}{20}\right)^{0,435}$	$\left(\frac{f_{ck}}{20}\right)^{0,350}$
Characteristic resistance in uncracked concrete C20/25	$N_{RK,p,ucr}$	[kN]	25	42	50
Increasing factor $N_{RK,p,ucr} = \psi_C \cdot N_{RK,p,ucr} (C20/25)$	ψ_C	[-]	$\left(\frac{f_{ck}}{20}\right)^{0,364}$	$\left(\frac{f_{ck}}{20}\right)^{0,213}$	$\left(\frac{f_{ck}}{20}\right)^{0,196}$
Splitting					
Characteristic resistance	$N^0_{RK,sp}$	[kN]	$\min(N_{RK,p}; N^0_{RK,c} \text{ } ^3)$		
Characteristic edge distance ²⁾	$C_{cr,sp}$	[mm]	$\frac{A_{sp} + 0,8 \cdot (h_{sp} - h_{ef})^2}{(3,41 \cdot h_{sp} - 0,59 \cdot h_{ef})}$		
Characteristic spacing	$S_{cr,sp}$	[mm]	$2 \cdot C_{cr,sp}$		
Concrete cone failure					
Effective anchorage depth	h_{ef}	[mm]	60	70	85
Characteristic edge distance	$C_{cr,N}$	[mm]	$1,5 \cdot h_{ef}$		
Characteristic spacing	$S_{cr,N}$	[mm]	$2 \cdot C_{cr,N}$		
Factor	cracked concrete	$k_{cr,N}$	7,7		
	uncracked concrete	$k_{ucr,N}$	11,0		

¹⁾ In absence of other national regulations

²⁾ Applicable concrete thickness h_{sp} and area A_{sp} according to Table B3 to determine characteristic edge distance $C_{cr,sp}$

³⁾ $N^0_{RK,c}$ according to EN 1992-4:2018

Wedge Anchor BZ3 dynamic

Performance

Characteristic values for **tension loads, A4** and **HCR**

Annex C3

Table C4: Characteristic values for **shear loads** under static and quasi-static action

Anchor size				M10	M12	M16
Installation factor		γ_{inst}	[-]	1,0		
Steel failure <u>without</u> lever arm						
Characteristic resistance	vZ	$V^0_{Rk,s}$	[kN]	26,8	38,3	60,0
	A4 / HCR	$V^0_{Rk,s}$	[kN]	27,8	39,8	69,5
Partial factor ¹⁾		γ_{Ms}	[-]	1,25		
Ductility factor		k_7	[-]	1,0		
Steel failure <u>with</u> lever arm						
Characteristic bending resistance	vZ	$M^0_{Rk,s}$	[Nm]	60	105	240
	A4 / HCR	$M^0_{Rk,s}$	[Nm]	55	99	223
Partial factor ¹⁾		γ_{Ms}	[-]	1,25		
Concrete pry-out failure						
Pry-out factor	vZ	k_8	[-]	3,1	3,0	3,6
	A4 / HCR	k_8	[-]	2,8	3,3	3,4
Concrete edge failure						
Effective length of fastener in shear loading		l_f	[mm]	h_{ef}		
Outside diameter of fastener		d_{nom}	[mm]	10	12	16

¹⁾ In absence of other national regulations

Wedge Anchor BZ3 dynamic

Performance
Characteristic values for **shear loads**

Annex C4

Table C5: Characteristic values for seismic loading, performance category C1

Anchor size				M10	M12	M16
Effective anchorage depth	$h_{ef} \geq$	[mm]		60	70	85
Tension load						
Installation factor	γ_{inst}	[-]		1,0		
Steel failure						
Characteristic resistance	VZ	$N_{Rk,s,C1}$	[kN]	30,4	44,9	79,3
	A4 / HCR	$N_{Rk,s,C1}$	[kN]	30,4	44,9	74,6
Pull-out						
Characteristic resistance	VZ	$N_{Rk,p,C1}$	[kN]	15,0	22,0	30,0
	A4 / HCR	$N_{Rk,p,C1}$	[kN]	17,0	22,0	35,0
Shear load						
Steel failure without lever arm						
Characteristic resistance	VZ	$V_{Rk,s,C1}$	[kN]	24,4	33,8	52,3
	A4 / HCR	$V_{Rk,s,C1}$	[kN]	22,2	33,2	64,3
Factor for anchorages without annular gap	α_{gap}	[-]		1,0		

Table C6: Characteristic values for seismic loading, performance category C2

Anchor size				M10	M12	M16
Effective anchorage depth	$h_{ef} \geq$	[mm]		60	70	85
Tension load						
Installation factor	γ_{inst}	[-]		1,0		
Steel failure						
Characteristic resistance	VZ	$N_{Rk,s,C2}$	[kN]	30,4	44,9	79,3
	A4 / HCR	$N_{Rk,s,C2}$	[kN]	30,4	44,9	74,6
Pull-out						
Characteristic resistance	VZ	$N_{Rk,p,C2}$	[kN]	12,5	19,0	35,2
	A4 / HCR	$N_{Rk,p,C2}$	[kN]	7,7	13,8	29,4
Shear load						
Steel failure without lever arm						
Characteristic resistance	VZ	$V_{Rk,s,C2}$	[kN]	19,0	28,0	43,3
	A4 / HCR	$V_{Rk,s,C2}$	[kN]	15,9	25,6	46,1
Factor for anchorages without annular gap	α_{gap}	[-]		1,0		

Wedge Anchor BZ3 dynamic
Performance
 Characteristic resistance for **seismic loading**
Annex C5

Table C7: Characteristic values for tension and shear load under fire exposure, steel, zinc plated

Anchor size				M10	M12	M16
Tension load						
Steel failure						
Characteristic resistance	R30	$N_{Rk,s,fi}$	[kN]	2,6	4,6	7,7
	R60			1,9	3,3	5,6
	R90			1,3	2,1	3,5
	R120			1,0	1,5	2,5
Shear load						
Steel failure <u>without</u> lever arm						
Characteristic resistance	R30	$V_{Rk,s,fi}$	[kN]	7,5	12,3	20,7
	R60			5,1	8,5	14,2
	R90			2,7	4,6	7,7
	R120			1,6	2,7	4,5
Steel failure <u>with</u> lever arm						
Characteristic resistance	R30	$M^0_{Rk,s,fi}$	[Nm]	9,6	19,1	43,8
	R60			6,6	13,1	30,1
	R90			3,5	7,2	16,4
	R120			2,0	4,2	9,6

$N_{Rk,p,fi}$ and $N_{Rk,c,fi}$ according to EN 1992-4:2018

Wedge Anchor BZ3 dynamic	Annex C6
Performance Characteristic values under fire exposure, steel, zinc plated	

Table C8: Characteristic values for tension and shear load under fire exposure, A4 and HCR

Anchor size				M10	M12	M16
Tension load						
Steel failure						
Characteristic resistance	R30	$N_{Rk,s,fi}$	[kN]	6,9	11,0	18,1
	R60			5,0	8,0	13,1
	R90			3,1	4,9	8,1
	R120			2,1	3,4	5,6
Shear load						
Steel failure <u>without</u> lever arm						
Characteristic resistance	R30	$V_{Rk,s,fi}$	[kN]	17,6	32,0	52,6
	R60			12,6	22,6	37,1
	R90			7,5	13,1	21,5
	R120			5,0	8,4	13,8
Steel failure <u>with</u> lever arm						
Characteristic resistance	R30	$M^0_{Rk,s,fi}$	[Nm]	22,7	49,8	111,5
	R60			16,2	35,1	78,6
	R90			9,7	20,4	45,6
	R120			6,5	13,0	29,2

$N_{Rk,p,fi}$ and $N_{Rk,c,fi}$ according to EN 1992-4:2018

Wedge Anchor BZ3 dynamic	Annex C7
Performance Characteristic values under fire exposure, A4 and HCR	

Table C9: Displacements under tension load, steel, zinc plated

Anchor size			M10	M12	M16
Displacements under static or quasi-static action					
$\delta_{N0} = \delta_{N0\text{-factor}} \cdot N$			N: acting tension load		
$\delta_{N\infty} = \delta_{N\infty\text{-factor}} \cdot N$					
Cracked concrete					
Factor for displacement	$\delta_{N0\text{-factor}}$	[mm/kN]	0,05	0,04	0,03
	$\delta_{N\infty\text{-factor}}$	[mm/kN]	0,20	0,15	0,11
Uncracked concrete					
Factor for displacement	$\delta_{N0\text{-factor}}$	[mm/kN]	0,01	0,004	0,005
	$\delta_{N\infty\text{-factor}}$	[mm/kN]	0,03	0,03	0,03
Displacement under seismic action C2					
Displacements for DLS	$\delta_{N,C2(DLS)}$	[mm]	4,7	4,2	4,5
Displacements for ULS	$\delta_{N,C2(ULS)}$	[mm]	16,1	12,9	12,8

Table C10: Displacements under tension load, A4 and HCR

Anchor size			M10	M12	M16
Displacements under static or quasi-static action					
$\delta_{N0} = \delta_{N0\text{-factor}} \cdot N$			N: acting tension load		
$\delta_{N\infty} = \delta_{N\infty\text{-factor}} \cdot N$					
Cracked concrete					
Factor for displacement	$\delta_{N0\text{-factor}}$	[mm/kN]	0,06	0,05	0,02
	$\delta_{N\infty\text{-factor}}$	[mm/kN]	0,17	0,16	0,08
Uncracked concrete					
Factor for displacement	$\delta_{N0\text{-factor}}$	[mm/kN]	0,00	0,001	0,00
	$\delta_{N\infty\text{-factor}}$	[mm/kN]	0,05	0,05	0,05
Displacement under seismic action C2					
Displacements for DLS	$\delta_{N,C2(DLS)}$	[mm]	4,1	5,7	5,1
Displacements for ULS	$\delta_{N,C2(ULS)}$	[mm]	16,8	18,0	13,9

Wedge Anchor BZ3 dynamic

Performance

Displacements under tension load

Annex C8

Table C11: Displacements under shear load, steel, zinc plated

Anchor size			M10	M12	M16
Displacements under static or quasi-static action					
$\delta_{V0} = \delta_{V0\text{-factor}} \cdot V$ V: acting shear load					
$\delta_{V\infty} = \delta_{V\infty\text{-factor}} \cdot V$					
Factor for displacement	$\delta_{V0\text{-factor}}$	[mm/kN]	0,09	0,09	0,07
	$\delta_{V\infty\text{-factor}}$	[mm/kN]	0,13	0,14	0,11
Displacement under seismic action C2					
Displacements for DLS	$\delta_{V,C2(DLS)}$	[mm]	3,1	3,7	3,8
Displacements for ULS	$\delta_{V,C2(ULS)}$	[mm]	5,5	9,9	9,6

Table C12: Displacements under shear load, A4 and HCR

Anchor size			M10	M12	M16
Displacements under static or quasi-static action					
$\delta_{V0} = \delta_{V0\text{-factor}} \cdot V$ V: acting shear load					
$\delta_{V\infty} = \delta_{V\infty\text{-factor}} \cdot V$					
Factor for displacement	$\delta_{V0\text{-factor}}$	[mm/kN]	0,14	0,12	0,09
	$\delta_{V\infty\text{-factor}}$	[mm/kN]	0,20	0,17	0,14
Displacement under seismic action C2					
Displacements for DLS	$\delta_{V,C2(DLS)}$	[mm]	3,5	4,2	4,4
Displacements for ULS	$\delta_{V,C2(ULS)}$	[mm]	8,4	11,8	11,1

Wedge Anchor BZ3 dynamic
Performance
 Displacements under shear load
Annex C9