

PROHLÁŠENÍ O VLASTNOSTECH

DoP č. MKT-1.1-300_cz

- ✧ **Jedinečný identifikační kód typu výrobku:** Nárázová kotva MKT E/ES
- ✧ **Zamýšlené/zamýšlená použití:** Rozšiřující hmoždinka pro ukotvení ne prasklý beton/
viz příloha / Annex B
- ✧ **Výrobce:** MKT Metall-Kunststoff-Technik GmbH & Co.KG
Auf dem Immel 2
67685 Weilerbach
- ✧ **Systém/systemy POSV:** 1
- ✧ **Evropský dokument pro posuzování:** ETAG 001-4
Evropské technické posouzení: ETA-02/0020, 01.03.2016
Subjekt pro technické posuzování: DIBt, Berlin
Oznámený subjekt/oznámené subjekty: NB 2873 – Technische Universität Darmstadt

✧ **Deklarovaná vlastnost / Deklarované vlastnosti:**

Základní charakteristiky	Vlastnosti
Mechanická odolnost a stabilita (BWR 1)	
Charakteristická únosnost v tahu a příčném zatížení	Příloha/Annex C1 – C4
Vzdálenosti od okraje a vzdálenosti od středu	Příloha/Annex C1 – C2
Posuny	Příloha/Annex C5
Požární bezpečnost (BWR 2)	
Chování při požáru	Třída A1
Požární odolnost	NPD (No Performance Determined) žádná vlastnost není stanovena

Vlastnosti výše uvedeného výrobku jsou ve shodě se souborem deklarovaných vlastností. Toto prohlášení o vlastnostech se v souladu s nařízením (EU) č. 305/2011 vydává na výhradní odpovědnost výrobce uvedeného výše.

Podepsáno za výrobce a jeho jménem:

Stefan Weustenhagen

(Výkonný ředitel)
Weilerbach, 01.01.2021

p.p. 
Dipl.-Ing. Detlef Bigalke
(Vedoucí vývoje produktu)



Originál tohoto prohlášení byl napsán v němčině. V případě odchylek v překladu platí německá verze.

Specifications of intended use

Anchorage subject to:

- Static and quasi-static loads

Base materials:

- Reinforced or unreinforced normal weight concrete according to EN 206-1:2000
- Non-cracked concrete
- Strength classes C20/25 to C50/60 according to EN 206-1:2000

Use conditions:

- Structures subject to dry internal conditions (zinc plated steel, stainless steel or high corrosion resistant steel).
- Structures subject to external atmospheric exposure including industrial and marine environment or exposure to permanently damp internal condition, if no particular aggressive conditions exist (stainless steel or high corrosion resistant steel).
- Structures subject to external atmospheric exposure and to permanently damp internal condition, if other particular aggressive conditions (high corrosion resistant steel).

Note: Particular aggressive conditions are e.g. permanent, alternating immersion in seawater or the splash zone of seawater, chloride atmosphere of indoor pools or atmosphere with extreme chemical pollution (e.g. in desulphurization plants or road tunnels where de-icing materials are used.)

Design:

- Anchorages are designed under the responsibility of an engineer experienced in anchorages and concrete work.
- Verifiable calculation notes and drawings are prepared taking account of the loads to be anchored. The position of the anchor is indicated on the design drawings (e.g. position of the anchor relative to reinforcement or to supports, etc.).
- The strength class and the length of the fastening screw or threaded rod shall be defined by the designing engineer
- Anchorages under static or quasi-static actions are designed in accordance with:
 - ETAG 001, Annex C, design method A, Edition August 2010 or
 - CEN/TS 1992-4:2009, Annex C, design method A

Installation:

- Anchor installation carried out by appropriately qualified personnel and under the supervision of the person responsible for technical matters of the site,
- Anchor installation in accordance with the manufacturer's specifications and drawings and using the appropriate tools,
- Drill hole by hammer drilling only,
- Positioning of the drill holes without damaging the reinforcement.

Drop-in Anchor E / ES

Intended use
Specifications

Annex B1

Table B1: Installation parameters

Anchor size		M6x30	M8x30	M8x40	M10x30	M10x40	M12x50	M12x80	M16x65	M16x80	M20x80
Depth of drill hole	$h_0 =$ [mm]	30	30	40	30	40	50	80	65	80	80
Drill hole diameter	$d_0 =$ [mm]	8	10	10	12	12	15	15	20	20	25
Cutting diameter of drill bit	$d_{cut} \leq$ [mm]	8,45	10,45	10,45	12,5	12,5	15,5	15,5	20,55	20,55	25,55
Max. installation torque ¹⁾	$T_{inst} \leq$ [Nm]	4	8	8	15	15	35	35	60	60	120
Diameter of clearance hole in the fixture	$d_f \leq$ [mm]	7	9	9	12	12	14	14	18	18	22
Available thread length	L_{th} [mm]	13	13	20	12	15	18	45	23	38	34
Minimum screw-in depth	L_{sdmin} [mm]	7	9	9	10	11	13	13	18	18	22
Steel, zinc plated											
Minimum thickness of member	h_{min} [mm]	100	100	100	120	120	130	130	160	160	200
Minimum spacing	s_{min} [mm]	55	60	80	100	100	120	120	150	150	160
Minimum edge distance	c_{min} [mm]	95	95	95	115	135	165	165	200	200	260
Stainless steel A4, HCR											
Minimum thickness of member	h_{min} [mm]	100	100	100	-	130	140	140	160	160	250
Minimum spacing	s_{min} [mm]	50	60	80	-	100	120	120	150	150	160
Minimum edge distance	c_{min} [mm]	80	95	95	-	135	165	165	200	200	260

¹⁾ If the screw or threaded rod is otherwise secured against unscrewing, the torque can be omitted.

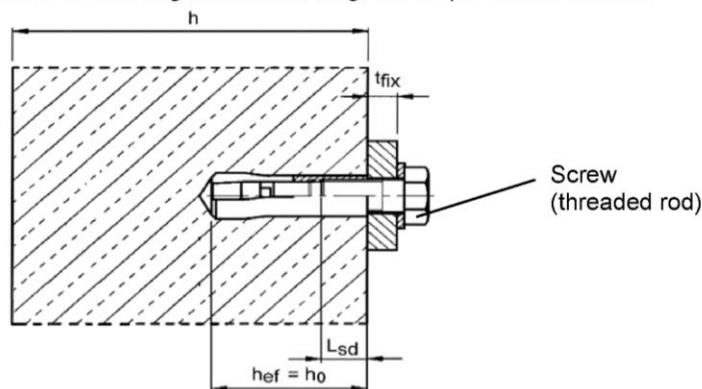

Requirements of the fastening screw or the threaded rod and nut according to the engineering documents:

- Minimum screw-in depth L_{sdmin} see Table B1
- The length of screw or the threaded rod shall be determined depending on the thickness of fixture t_{fix} , available thread length L_{th} (= maximum screw-in depth) and the minimum screw-in depth L_{sdmin} .
- $A_5 > 8\%$ ductility

Steel, zinc plated

- Property class 4.6 / 5.6 / 5.8 or 8.8 according to EN ISO 898-1:2013 or EN ISO 898-2:2012

Stainless steel A4

- Material 1.4401; 1.4404; 1.4578; 1.4571; 1.4439; 1.4362 EN 10088:2005
- Property class 70 or 80 according to EN ISO 3506:2010

High corrosion resistant steel (HCR)

- Material 1.4529; 1.4565 acc. to EN 10088:2005
- Property class 70 or 80 acc. to EN ISO 3506:2010

Drop-in Anchor E / ES

Intended use
Installation parameters

Annex B2

Installation instructions

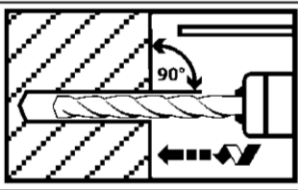
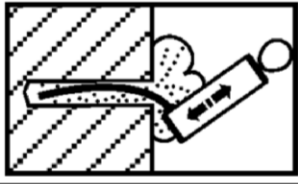
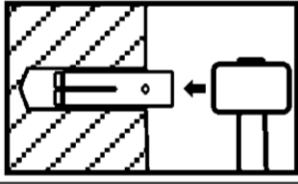
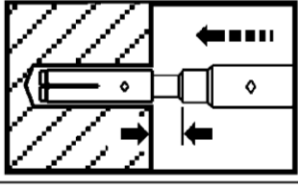
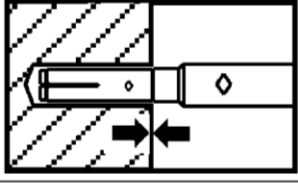
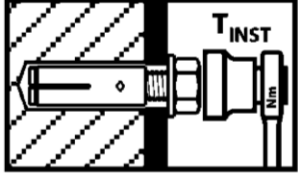
1		Drill hole perpendicular to concrete surface.
2		Blow out dust.
3		Drive in anchor.
4		Drive in cone by using setting tool.
5		Shoulder of setting tool must fit on anchor rim.
6		Apply installation torque T_{inst} by using calibrated torque wrench.

Drop-in Anchor E / ES

Intended use
Installation instructions

Annex B3

Table C1: Characteristic values for tension loads, zinc plated steel

Anchor size			M6x30 ¹⁾	M8x30 ¹⁾	M8x40	M10x30 ¹⁾	M10x40	M12x50	M12x80	M16x65 M16x80	M20x80
Installation safety factor	$\gamma_2 = \gamma_{inst}$	[-]	1,2								
Steel failure											
Characteristic resistance Steel 4.6	$N_{Rk,s}$	[kN]	8,0	14,6	23,2		33,7		62,8	98,0	
Partial safety factor	γ_{Ms}	[-]	2,0								
Characteristic resistance Steel 5.6	$N_{Rk,s}$	[kN]	10,0	18,3	18,0	20,2	42,1		78,3	122,4	
Partial safety factor	γ_{Ms}	[-]	2,0		1,5		2,0				
Characteristic resistance Steel 5.8	$N_{Rk,s}$	[kN]	10,0	17,6	18,3	18,0	20,2	40,2	42,1	67,1	106,4
Partial safety factor	γ_{Ms}	[-]	1,5						1,6		
Characteristic resistance Steel 8.8	$N_{Rk,s}$	[kN]	15,0	17,6	19,9	18,0	20,2	40,2	43,0	67,1	106,4
Partial safety factor	γ_{Ms}	[-]	1,5						1,6		
Pull-out failure											
Characteristic resistance in concrete C20/25	$N_{Rk,p}$	[kN]	2)	2)	9	2)	2)	2)		2)	2)
Increasing factor for $N_{Rk,p}$	ψ_C	[-]	$\left(\frac{f_{ck,cube}}{25}\right)^{0,3}$								
Concrete cone failure and splitting											
Effective anchorage depth	h_{ef}	[mm]	30	30	40	30	40	50		65	80
Spacing (edge distance)	$s_{cr,N} (= 2 c_{cr,N})$	[mm]	3 h_{ef}								
	$s_{cr,sp} (= 2 c_{cr,sp})$	[mm]	190	190	190	230	270	330		400	520
Factor acc. to CEN/TS 1992-4	k_{ucr}	[-]	10,1								

¹⁾ Use restricted to anchoring of structural components statically indeterminate

²⁾ Pull-out is not decisive

Drop-in Anchor E / ES

Performance
Characteristic values for **tension loads, zinc plated steel**

Annex C1

Table C2: Characteristic values for tension loads, stainless steel A4, HCR

Anchor size			M6x30 ¹⁾	M8x30 ¹⁾	M8x40	M10x40	M12x50 M12x80	M16x65 M16x80	M20x80
Installation safety factor	$\gamma_2 = \gamma_{inst}$	[-]	1,0						
Steel failure									
Characteristic resistance (property class 70)	$N_{Rk,s}$	[kN]	14,1	23,3		29,4	50,2	83,8	133,0
Characteristic resistance (property class 80)	$N_{Rk,s}$	[kN]	17,5	23,3		29,4	50,2	83,8	133,0
Partial safety factor	γ_{Ms}	[-]	1,87						
Pull-out failure									
Characteristic resistance in concrete C20/25	$N_{Rk,p}$	[kN]	2)	2)	9	2)	2)	2)	2)
Increasing factor for $N_{Rk,p}$	ψ_C	[-]	$\left(\frac{f_{ck,cube}}{25}\right)^{0,5}$						
Concrete cone failure and splitting									
Effective anchorage depth	h_{ef}	[mm]	30 ³⁾	30	40	40	50	65	80
Spacing (edge distance)	$s_{cr,N} (= 2 c_{cr,N})$	[mm]	3 h_{ef}						
	$s_{cr,sp} (= 2 c_{cr,sp})$	[mm]	160	190	190	270	330	400	520
Factor acc. to CEN/TS 1992-4	k_{ucr}	[-]	10,1						

¹⁾ Use restricted to anchoring of structural components statically indeterminate

²⁾ Pull-out is not decisive.

³⁾ For proof against concrete cone failure as per ETAG 001, annex C or CEN/TS 1992-4-4, $N_{Rk,c}^0$ must be multiplied by the factor $(25/f_{ck,cube})^{0,2}$.

Drop-in Anchor E / ES

Performance
Characteristic values for tension loads, stainless steel A4, HCR

Annex C2

Table C3: Characteristic values for shear loads, zinc plated steel

Anchor size			M6x30 ¹⁾	M8x30 ¹⁾	M8x40	M10x30 ¹⁾	M10x40	M12x50	M12x80	M16x65 M16x80	M20x80
Steel failure without lever arm											
Characteristic resistance Steel 4.6	$V_{Rk,s}$	[kN]	4,0	7,3	11,6	9,6	16,8	31,3	49,0		
Partial safety factor	γ_{Ms}	[-]	1,67								
Characteristic resistance Steel 5.6	$V_{Rk,s}$	[kN]	5,0	9,1	10,1	9,6	21,1	39,2	61,2		
Partial safety factor	γ_{Ms}	[-]	1,67			1,25	1,67				
Characteristic resistance Steel 5.8	$V_{Rk,s}$	[kN]	5,0	6,9	10,1	7,2	19,4	21,1	33,5	53,2	
Partial safety factor	γ_{Ms}	[-]	1,25						1,33		
Characteristic resistance Steel 8.8	$V_{Rk,s}$	[kN]	5,0	6,9	10,1	7,2	19,4	21,5	33,5	53,2	
Partial safety factor	γ_{Ms}	[-]	1,25						1,33		
Factor of ductility	k_2	[-]	1,0								
Steel failure with lever arm											
Characteristic resistance Steel 4.6	$M^0_{Rk,s}$	[Nm]	6,1	15	30	30	52	133	259		
Partial safety factor	γ_{Ms}	[-]	1,67								
Characteristic resistance Steel 5.6	$M^0_{Rk,s}$	[Nm]	7,6	19	37	37	65	166	324		
Partial safety factor	γ_{Ms}	[-]	1,67								
Characteristic resistance Steel 5.8	$M^0_{Rk,s}$	[Nm]	7,6	19	37	37	65	166	324		
Partial safety factor	γ_{Ms}	[-]	1,25								
Characteristic resistance Steel 8.8	$M^0_{Rk,s}$	[Nm]	12	30	59	60	105	266	519		
Partial safety factor	γ_{Ms}	[-]	1,25								
Factor of ductility	k_2	[-]	1,0								
Concrete pry-out failure											
Factor k acc. to ETAG 001, Annex C or k_3 acc. to CEN/TS	$k_{(3)}$	[-]	1,0				1,5		2,0		
Concrete edge failure											
Effective length of anchor under shear loading	l_f	[mm]	30	30	40	30	40	50	65	80	
Outside diameter of anchor	d_{nom}	[mm]	8	10	10	12	12	15	20	25	

¹⁾ Use restricted to anchoring of structural components statically indeterminate

Drop-in Anchor E / ES

Performance
Characteristic values for **shear loads, zinc plated steel**

Annex C3

Table C4: Characteristic values for shear loads, stainless steel A4, HCR

Anchor size			M6x30 ¹⁾	M8x30 ¹⁾	M8x40	M10x40	M12x50 M12x80	M16x65 M16x80	M20x80
Steel failure without lever arm									
Characteristic resistance (property class 70)	$V_{Rk,s}$	[kN]	7,0	10,6	13,4	25,1	41,9	66,5	
Characteristic resistance (property class 80)	$V_{Rk,s}$	[kN]	8,7	10,6	13,4	25,1	41,9	66,5	
Partial safety factor	γ_{Ms}	[-]	1,56						
Factor of ductility	k_2	[-]	1,0						
Steel failure with lever arm									
Characteristic resistance (property class 70)	$M^0_{Rk,s}$	[Nm]	11	26	52	92	233	454	
Partial safety factor	γ_{Ms}	[-]	1,56						
Characteristic resistance (property class 80)	$M^0_{Rk,s}$	[Nm]	12	30	60	105	266	519	
Partial safety factor	γ_{Ms}	[-]	1,33						
Factor of ductility	k_2	[-]	1,0						
Concrete pry-out failure									
Factor k acc. to ETAG 001, Annex C or k_3 acc. to CEN/TS	$k_{(3)}$	[-]	1,0	1,7	1,7	2,0			
Concrete edge failure									
Effective length of anchor under shear loading	l_f	[mm]	30	30	40	40	50	65	80
Outside diameter of anchor	d_{nom}	[mm]	8	10	10	12	15	20	25

¹⁾ Use restricted to anchoring of structural components statically indeterminate

Drop-in Anchor E / ES

Performance
Characteristic values for **shear loads, stainless steel A4, HCR**

Annex C4

Table C5: Displacements under tension loads

Anchor size			M6x30	M8x30	M8x40	M10x30	M10x40	M12x50 M12x80	M16x65 M16x80	M20x80
Steel zinc plated										
Tension load in non-cracked concrete	N	[kN]	3	3	3,6	3,3	4,8	6,4	10	14,8
Displacement	δ_{N0}	[mm]	0,24							
	$\delta_{N\infty}$	[mm]	0,36							
Stainless steel A4 / HCR										
Tension load in non-cracked concrete	N	[kN]	4	4	4,3	-	6,1	8,5	12,6	17,2
Displacement	δ_{N0}	[mm]	0,12							
	$\delta_{N\infty}$	[mm]	0,24							

Table C6: Displacements under shear loads

Anchor size			M6x30	M8x30	M8x40	M10x30	M10x40	M12x50 M12x80	M16x65 M16x80	M20x80
Steel zinc plated										
Shear load in non-cracked concrete	V	[kN]	2	4	4	5,7	4,0	11,3	18,8	32,2
Displacement	δ_{V0}	[mm]	0,9	0,9	1,0	1,5	0,6	1,2	1,2	1,6
	$\delta_{V\infty}$	[mm]	1,3	1,3	1,5	2,3	0,9	1,9	1,9	2,4
Stainless steel A4 / HCR										
Shear load in non-cracked concrete	V	[kN]	3,5	5,2	5,2	-	6,5	11,5	19,2	30,4
Displacement	δ_{V0}	[mm]	1,9	1,1	0,7	-	1,0	1,7	2,4	2,6
	$\delta_{V\infty}$	[mm]	2,8	1,6	1,0	-	1,5	2,6	3,6	3,8

Drop-in Anchor E / ESPerformance
Displacements**Annex C5**