

## IZJAVA O SVOJSTVIMA

DoP Br. MKT-1.1-300\_hr

- ✧ **Jedinstvena identifikacijska oznaka vrste proizvoda:** MKT sidro E/ES
- ✧ **Namjena/namjene:** Rastegljivo sidro za sidrenje u betonu koji nije pukao, vidi Prilog/Annex B
- ✧ **Proizvođač:** MKT Metall-Kunststoff-Technik GmbH & Co.KG  
Auf dem Immel 2  
67685 Weilerbach
- ✧ **Sustav/sustavi za ocjenu i provjeru stalnosti svojstava (AVCP):** 1
- ✧ **Europski dokument za ocjenjivanje:** ETAG 001-4  
Europska tehnička ocjena: ETA-02/0020, 01.03.2016  
Tijelo za tehničko ocjenjivanje: DIBt, Berlin  
Prijavljeno tijelo/prijavljena tijela: NB 2873 – Technische Universität Darmstadt

✧ **Objavljena svojstva:**

Bitnih značajka	Svojstva
<b>TEMELJNI ZAHTJEVI ZA GRAĐEVINE (BWR 1)</b>	
Karakteristični otpor pri vlačnom i poprečnom opterećenju	Prilog/Annex C1 – C4
Udaljenosti ruba i središta	Prilog/Annex C1 – C2
Pomaci	Prilog/Annex C5
<b>Sigurnost u slučaju požara (BWR 2)</b>	
Ponašanje požara	Klasa A1
Otpornost na vatru	NPD (No Performance Determined) bez utvrđenog svojstva

Prije utvrđeno svojstvo proizvoda u skladu je s objavljenim svojstvima. Ova izjava o svojstvima izdaje se, u skladu s Uredbom (EU) br. 305/2011, pod isključivom odgovornošću prethodno utvrđenog proizvođača.

Za proizvođača i u njegovo ime potpisao:

  
**Stefan Weustenhagen**  
(generalni direktor)  
Weilerbach, 01.01.2021

p.p.   
**Dipl.-Ing. Detlef Bigalke**  
(Voditelj razvoja proizvoda)



Izvornik ove izjave o izvedbi pisan je na njemačkom jeziku. U slučaju odstupanja u prijevodu vrijedi njemačka verzija.

## Specifications of intended use

### Anchorage subject to:

- Static and quasi-static loads

### Base materials:

- Reinforced or unreinforced normal weight concrete according to EN 206-1:2000
- Non-cracked concrete
- Strength classes C20/25 to C50/60 according to EN 206-1:2000

### Use conditions:

- Structures subject to dry internal conditions (zinc plated steel, stainless steel or high corrosion resistant steel).
- Structures subject to external atmospheric exposure including industrial and marine environment or exposure to permanently damp internal condition, if no particular aggressive conditions exist (stainless steel or high corrosion resistant steel).
- Structures subject to external atmospheric exposure and to permanently damp internal condition, if other particular aggressive conditions (high corrosion resistant steel).

Note: Particular aggressive conditions are e.g. permanent, alternating immersion in seawater or the splash zone of seawater, chloride atmosphere of indoor pools or atmosphere with extreme chemical pollution (e.g. in desulphurization plants or road tunnels where de-icing materials are used.)

### Design:

- Anchorages are designed under the responsibility of an engineer experienced in anchorages and concrete work.
- Verifiable calculation notes and drawings are prepared taking account of the loads to be anchored. The position of the anchor is indicated on the design drawings (e.g. position of the anchor relative to reinforcement or to supports, etc.).
- The strength class and the length of the fastening screw or threaded rod shall be defined by the designing engineer
- Anchorages under static or quasi-static actions are designed in accordance with:
  - ETAG 001, Annex C, design method A, Edition August 2010 or
  - CEN/TS 1992-4:2009, Annex C, design method A

### Installation:

- Anchor installation carried out by appropriately qualified personnel and under the supervision of the person responsible for technical matters of the site,
- Anchor installation in accordance with the manufacturer's specifications and drawings and using the appropriate tools,
- Drill hole by hammer drilling only,
- Positioning of the drill holes without damaging the reinforcement.

## Drop-in Anchor E / ES

Intended use  
Specifications

Annex B1

**Table B1: Installation parameters**

Anchor size		M6x30	M8x30	M8x40	M10x30	M10x40	M12x50	M12x80	M16x65	M16x80	M20x80
Depth of drill hole	$h_0 =$ [mm]	30	30	40	30	40	50	80	65	80	80
Drill hole diameter	$d_0 =$ [mm]	8	10	10	12	12	15	15	20	20	25
Cutting diameter of drill bit	$d_{cut} \leq$ [mm]	8,45	10,45	10,45	12,5	12,5	15,5	15,5	20,55	20,55	25,55
Max. installation torque <sup>1)</sup>	$T_{inst} \leq$ [Nm]	4	8	8	15	15	35	35	60	60	120
Diameter of clearance hole in the fixture	$d_f \leq$ [mm]	7	9	9	12	12	14	14	18	18	22
Available thread length	$L_{th}$ [mm]	13	13	20	12	15	18	45	23	38	34
Minimum screw-in depth	$L_{sdmin}$ [mm]	7	9	9	10	11	13	13	18	18	22
<b>Steel, zinc plated</b>											
Minimum thickness of member	$h_{min}$ [mm]	100	100	100	120	120	130	130	160	160	200
Minimum spacing	$s_{min}$ [mm]	55	60	80	100	100	120	120	150	150	160
Minimum edge distance	$c_{min}$ [mm]	95	95	95	115	135	165	165	200	200	260
<b>Stainless steel A4, HCR</b>											
Minimum thickness of member	$h_{min}$ [mm]	100	100	100	-	130	140	140	160	160	250
Minimum spacing	$s_{min}$ [mm]	50	60	80	-	100	120	120	150	150	160
Minimum edge distance	$c_{min}$ [mm]	80	95	95	-	135	165	165	200	200	260

<sup>1)</sup> If the screw or threaded rod is otherwise secured against unscrewing, the torque can be omitted.

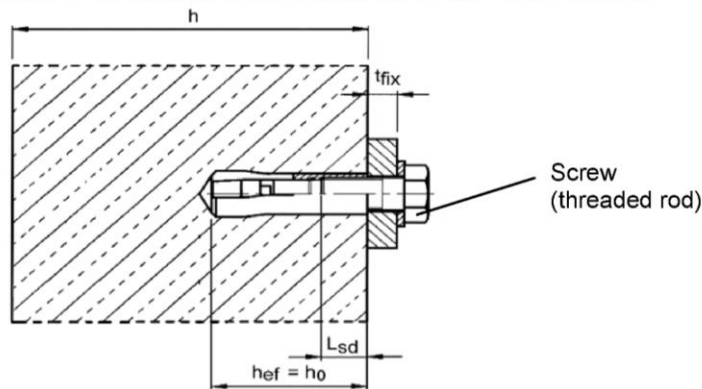

**Requirements of the fastening screw or the threaded rod and nut according to the engineering documents:**

- Minimum screw-in depth  $L_{sdmin}$  see Table B1
- The length of screw or the threaded rod shall be determined depending on the thickness of fixture  $t_{fix}$ , available thread length  $L_{th}$  (= maximum screw-in depth) and the minimum screw-in depth  $L_{sdmin}$ .
- $A_5 > 8\%$  ductility

**Steel, zinc plated**

- Property class 4.6 / 5.6 / 5.8 or 8.8 according to EN ISO 898-1:2013 or EN ISO 898-2:2012

**Stainless steel A4**

- Material 1.4401; 1.4404; 1.4578; 1.4571; 1.4439; 1.4362 EN 10088:2005
- Property class 70 or 80 according to EN ISO 3506:2010

**High corrosion resistant steel (HCR)**

- Material 1.4529; 1.4565 acc. to EN 10088:2005
- Property class 70 or 80 acc. to EN ISO 3506:2010

**Drop-in Anchor E / ES**

**Intended use**  
Installation parameters

**Annex B2**

## Installation instructions

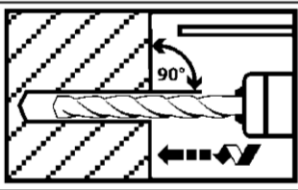
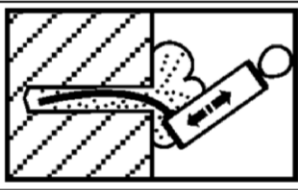
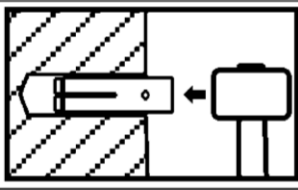
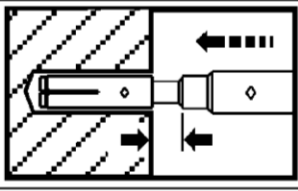
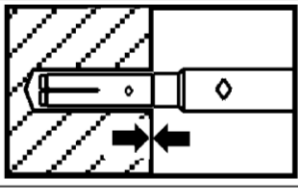
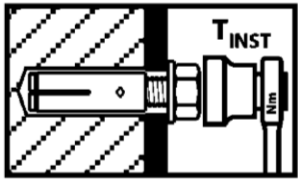
1		Drill hole perpendicular to concrete surface.
2		Blow out dust.
3		Drive in anchor.
4		Drive in cone by using setting tool.
5		Shoulder of setting tool must fit on anchor rim.
6		Apply installation torque $T_{inst}$ by using calibrated torque wrench.

### Drop-in Anchor E / ES

Intended use  
Installation instructions

Annex B3

**Table C1: Characteristic values for tension loads, zinc plated steel**

Anchor size			M6x30 <sup>1)</sup>	M8x30 <sup>1)</sup>	M8x40	M10x30 <sup>1)</sup>	M10x40	M12x50	M12x80	M16x65 M16x80	M20x80
Installation safety factor	$\gamma_2 = \gamma_{inst}$	[-]	1,2								
<b>Steel failure</b>											
Characteristic resistance Steel 4.6	$N_{Rk,s}$	[kN]	8,0	14,6		23,2		33,7		62,8	98,0
Partial safety factor	$\gamma_{Ms}$	[-]	2,0								
Characteristic resistance Steel 5.6	$N_{Rk,s}$	[kN]	10,0	18,3		18,0	20,2	42,1		78,3	122,4
Partial safety factor	$\gamma_{Ms}$	[-]	2,0			1,5		2,0			
Characteristic resistance Steel 5.8	$N_{Rk,s}$	[kN]	10,0	17,6	18,3	18,0	20,2	40,2	42,1	67,1	106,4
Partial safety factor	$\gamma_{Ms}$	[-]	1,5							1,6	
Characteristic resistance Steel 8.8	$N_{Rk,s}$	[kN]	15,0	17,6	19,9	18,0	20,2	40,2	43,0	67,1	106,4
Partial safety factor	$\gamma_{Ms}$	[-]	1,5							1,6	
<b>Pull-out failure</b>											
Characteristic resistance in concrete C20/25	$N_{Rk,p}$	[kN]	2)	2)	9	2)	2)	2)		2)	2)
Increasing factor for $N_{Rk,p}$	$\psi_C$	[-]	$\left(\frac{f_{ck,cube}}{25}\right)^{0,3}$								
<b>Concrete cone failure and splitting</b>											
Effective anchorage depth	$h_{ef}$	[mm]	30	30	40	30	40	50		65	80
Spacing (edge distance)	$s_{cr,N} (= 2 c_{cr,N})$	[mm]	3 $h_{ef}$								
	$s_{cr,sp} (= 2 c_{cr,sp})$	[mm]	190	190	190	230	270	330		400	520
Factor acc. to CEN/TS 1992-4	$k_{ucr}$	[-]	10,1								

<sup>1)</sup> Use restricted to anchoring of structural components statically indeterminate

<sup>2)</sup> Pull-out is not decisive

**Drop-in Anchor E / ES**

**Performance**  
Characteristic values for **tension loads, zinc plated steel**

**Annex C1**

**Table C2: Characteristic values for tension loads, stainless steel A4, HCR**

Anchor size			M6x30 <sup>1)</sup>	M8x30 <sup>1)</sup>	M8x40	M10x40	M12x50 M12x80	M16x65 M16x80	M20x80
Installation safety factor	$\gamma_2 = \gamma_{inst}$	[-]	1,0						
<b>Steel failure</b>									
Characteristic resistance (property class 70)	$N_{Rk,s}$	[kN]	14,1	23,3		29,4	50,2	83,8	133,0
Characteristic resistance (property class 80)	$N_{Rk,s}$	[kN]	17,5	23,3		29,4	50,2	83,8	133,0
Partial safety factor	$\gamma_{Ms}$	[-]	1,87						
<b>Pull-out failure</b>									
Characteristic resistance in concrete C20/25	$N_{Rk,p}$	[kN]	2)	2)	9	2)	2)	2)	2)
Increasing factor for $N_{Rk,p}$	$\psi_C$	[-]	$\left(\frac{f_{ck,cube}}{25}\right)^{0,5}$						
<b>Concrete cone failure and splitting</b>									
Effective anchorage depth	$h_{ef}$	[mm]	30 <sup>3)</sup>	30	40	40	50	65	80
Spacing (edge distance)	$s_{cr,N} (= 2 c_{cr,N})$	[mm]	3 $h_{ef}$						
	$s_{cr,sp} (= 2 c_{cr,sp})$	[mm]	160	190	190	270	330	400	520
Factor acc. to CEN/TS 1992-4	$k_{ucr}$	[-]	10,1						

<sup>1)</sup> Use restricted to anchoring of structural components statically indeterminate

<sup>2)</sup> Pull-out is not decisive.

<sup>3)</sup> For proof against concrete cone failure as per ETAG 001, annex C or CEN/TS 1992-4-4,  $N_{Rk,c}^0$  must be multiplied by the factor  $(25/f_{ck,cube})^{0,2}$ .

**Drop-in Anchor E / ES**

**Performance**  
Characteristic values for tension loads, stainless steel A4, HCR

**Annex C2**

**Table C3: Characteristic values for shear loads, zinc plated steel**

Anchor size		M6x30 <sup>1)</sup>	M8x30 <sup>1)</sup>	M8x40	M10x30 <sup>1)</sup>	M10x40	M12x50	M12x80	M16x65 M16x80	M20x80
<b>Steel failure without lever arm</b>										
Characteristic resistance Steel 4.6	$V_{Rk,s}$ [kN]	4,0	7,3	11,6	9,6	16,8	31,3	49,0		
Partial safety factor	$\gamma_{Ms}$ [-]	1,67								
Characteristic resistance Steel 5.6	$V_{Rk,s}$ [kN]	5,0	9,1	10,1	9,6	21,1	39,2	61,2		
Partial safety factor	$\gamma_{Ms}$ [-]	1,67			1,25	1,67				
Characteristic resistance Steel 5.8	$V_{Rk,s}$ [kN]	5,0	6,9	10,1	7,2	19,4	21,1	33,5	53,2	
Partial safety factor	$\gamma_{Ms}$ [-]	1,25					1,33			
Characteristic resistance Steel 8.8	$V_{Rk,s}$ [kN]	5,0	6,9	10,1	7,2	19,4	21,5	33,5	53,2	
Partial safety factor	$\gamma_{Ms}$ [-]	1,25					1,33			
Factor of ductility	$k_2$ [-]	1,0								
<b>Steel failure with lever arm</b>										
Characteristic resistance Steel 4.6	$M^0_{Rk,s}$ [Nm]	6,1	15	30	30	52	133	259		
Partial safety factor	$\gamma_{Ms}$ [-]	1,67								
Characteristic resistance Steel 5.6	$M^0_{Rk,s}$ [Nm]	7,6	19	37	37	65	166	324		
Partial safety factor	$\gamma_{Ms}$ [-]	1,67								
Characteristic resistance Steel 5.8	$M^0_{Rk,s}$ [Nm]	7,6	19	37	37	65	166	324		
Partial safety factor	$\gamma_{Ms}$ [-]	1,25								
Characteristic resistance Steel 8.8	$M^0_{Rk,s}$ [Nm]	12	30	59	60	105	266	519		
Partial safety factor	$\gamma_{Ms}$ [-]	1,25								
Factor of ductility	$k_2$ [-]	1,0								
<b>Concrete pry-out failure</b>										
Factor k acc. to ETAG 001, Annex C or $k_3$ acc. to CEN/TS	$k_{(3)}$ [-]	1,0				1,5			2,0	
<b>Concrete edge failure</b>										
Effective length of anchor under shear loading	$l_f$ [mm]	30	30	40	30	40	50	65	80	
Outside diameter of anchor	$d_{nom}$ [mm]	8	10	10	12	12	15	20	25	

<sup>1)</sup> Use restricted to anchoring of structural components statically indeterminate

**Drop-in Anchor E / ES**

**Performance**  
Characteristic values for **shear loads, zinc plated steel**

**Annex C3**

**Table C4: Characteristic values for shear loads, stainless steel A4, HCR**

Anchor size			M6x30 <sup>1)</sup>	M8x30 <sup>1)</sup>	M8x40	M10x40	M12x50 M12x80	M16x65 M16x80	M20x80
<b>Steel failure without lever arm</b>									
Characteristic resistance (property class 70)	$V_{Rk,s}$	[kN]	7,0	10,6		13,4	25,1	41,9	66,5
Characteristic resistance (property class 80)	$V_{Rk,s}$	[kN]	8,7	10,6		13,4	25,1	41,9	66,5
Partial safety factor	$\gamma_{Ms}$	[-]	1,56						
Factor of ductility	$k_2$	[-]	1,0						
<b>Steel failure with lever arm</b>									
Characteristic resistance (property class 70)	$M^0_{Rk,s}$	[Nm]	11	26		52	92	233	454
Partial safety factor	$\gamma_{Ms}$	[-]	1,56						
Characteristic resistance (property class 80)	$M^0_{Rk,s}$	[Nm]	12	30		60	105	266	519
Partial safety factor	$\gamma_{Ms}$	[-]	1,33						
Factor of ductility	$k_2$	[-]	1,0						
<b>Concrete pry-out failure</b>									
Factor k acc. to ETAG 001, Annex C or $k_3$ acc. to CEN/TS	$k_{(3)}$	[-]	1,0	1,7		1,7		2,0	
<b>Concrete edge failure</b>									
Effective length of anchor under shear loading	$l_f$	[mm]	30	30	40	40	50	65	80
Outside diameter of anchor	$d_{nom}$	[mm]	8	10	10	12	15	20	25

<sup>1)</sup> Use restricted to anchoring of structural components statically indeterminate

**Drop-in Anchor E / ES**

**Performance**  
Characteristic values for **shear loads, stainless steel A4, HCR**

**Annex C4**



**Table C5: Displacements under tension loads**

Anchor size			M6x30	M8x30	M8x40	M10x30	M10x40	M12x50 M12x80	M16x65 M16x80	M20x80
<b>Steel zinc plated</b>										
Tension load in non-cracked concrete	N	[kN]	3	3	3,6	3,3	4,8	6,4	10	14,8
Displacement	$\delta_{N0}$	[mm]	0,24							
	$\delta_{N\infty}$	[mm]	0,36							
<b>Stainless steel A4 / HCR</b>										
Tension load in non-cracked concrete	N	[kN]	4	4	4,3	-	6,1	8,5	12,6	17,2
Displacement	$\delta_{N0}$	[mm]	0,12							
	$\delta_{N\infty}$	[mm]	0,24							

**Table C6: Displacements under shear loads**

Anchor size			M6x30	M8x30	M8x40	M10x30	M10x40	M12x50 M12x80	M16x65 M16x80	M20x80
<b>Steel zinc plated</b>										
Shear load in non-cracked concrete	V	[kN]	2	4	4	5,7	4,0	11,3	18,8	32,2
Displacement	$\delta_{V0}$	[mm]	0,9	0,9	1,0	1,5	0,6	1,2	1,2	1,6
	$\delta_{V\infty}$	[mm]	1,3	1,3	1,5	2,3	0,9	1,9	1,9	2,4
<b>Stainless steel A4 / HCR</b>										
Shear load in non-cracked concrete	V	[kN]	3,5	5,2	5,2	-	6,5	11,5	19,2	30,4
Displacement	$\delta_{V0}$	[mm]	1,9	1,1	0,7	-	1,0	1,7	2,4	2,6
	$\delta_{V\infty}$	[mm]	2,8	1,6	1,0	-	1,5	2,6	3,6	3,8

**Drop-in Anchor E / ES**Performance  
Displacements**Annex C5**