



...eine starke Verbindung

## DÉCLARATION DES PERFORMANCES

DoP No MKT-1.2-101\_fr

- ✧ **Code d'identification unique du produit type:** **Ancre de fixation E / ES**
- ✧ **Usage(s) prévu(s):** Chevilles d'ancrage dans le béton pour systèmes non porteurs redondants, voir l'annexe / Annex B
- ✧ **Fabricant:** MKT Metall-Kunststoff-Technik GmbH & Co.KG  
Auf dem Immel 2  
67685 Weilerbach
- ✧ **Système(s) d'évaluation et de vérification de la constance des performances:** 2+
- ✧ **Document d'évaluation européen:** **EAD 330747-00-0601**  
Évaluation technique européenne: **ETA-05/0116, 27.05.2021**  
Organisme d'évaluation technique: DIBt, Berlin  
Organisme(s) notifié(s): NB 2873 – Technische Universität Darmstadt
- ✧ **Performance(s) déclarée(s):**

Caractéristiques essentielles	Performances
<b>Sécurité en cas d'incendie (BWR 2)</b>	
Le comportement du feu	Classe A1
Résistance au feu	Annexe/Annex C5
<b>Sécurité lors de l'utilisation (BWR 4)</b>	
Résistance caractéristique pour toutes les directions de charge et tous les modes de défaillance pour la méthode de conception simplifiée	Annexe/Annex B3, C1 – C4
Durabilité	Annexe/Annex B1

Les performances du produit identifié ci-dessus sont conformes aux performances déclarées. Conformément au règlement (UE) no 305/2011, la présente déclaration des performances est établie sous la seule responsabilité du fabricant mentionné ci-dessus.

Signé pour le fabricant et en son nom par:



**Stefan Weustenhagen**  
(Directeur général)  
**Weilerbach, 27.05.2021**

p.p. 

**Dipl.-Ing. Detlef Bigalke**  
(Directeur du développement de produits)



L'original de cette déclaration d'exécution a été rédigé en allemand. En cas de divergences dans la traduction, la version allemande fait foi.

## Specifications of intended use

Drop-in Anchor E / ES	Anchorage depth $h_{ef} \geq 30$ mm						
	M6x30	M8x30	M8x40	M10x30	M10x40	M12x50	M16x65
Steel, zinc plated				✓			
Stainless steel A4 and high corrosion resistant steel HCR		✓		-		✓	
Static and quasi-static loads				✓			
Fire exposure				✓			
Cracked and uncracked concrete				✓			
Solid concrete <b>C20/25 to C50/60</b>				✓			

Drop-in Anchor ES	Anchorage depth $h_{ef} = 25$ mm			
	M6x25	M8x25	M10x25	M12x25
Steel, zinc plated			✓	
Stainless steel A4 and high corrosion resistant steel HCR			-	
Static and quasi-static loads			✓	
Fire exposure (solid concrete, C20/25 to C50/60)			✓	
Cracked and uncracked concrete			✓	
Solid concrete <b>C12/15 to C50/60</b>			✓	
Precast pre-stressed hollow core slabs C30/37 to C50/60			✓	

**Use only for redundant, non-structural systems!**

### Base materials:

- Compacted, reinforced or unreinforced normal weight concrete (without fibers) acc. to EN 206:2013 + A1:2016

### Use conditions:

- Structures subject to dry internal conditions (zinc plated steel, stainless steel or high corrosion resistant steel)
- Structures subject to external atmospheric exposure (including industrial and marine environment) or exposure to permanently damp internal condition, if no particular aggressive conditions exist (stainless steel or high corrosion resistant steel)
- Structures subject to external atmospheric exposure and to permanently damp internal condition, if other particular aggressive conditions (high corrosion resistant steel)

Note: Particular aggressive conditions are e.g. permanent, alternating immersion in seawater or the splash zone of seawater, chloride atmosphere of indoor pools or atmosphere with extreme chemical pollution (e.g. in desulphurization plants or road tunnels where de-icing materials are used.)

<b>Drop-in Anchor E / ES</b>	<b>Annex B1</b>
Intended use Specifications	

## Specifications of intended use

### Design:

- Anchorages are designed under the responsibility of an engineer experienced in anchorages and concrete work
- Verifiable calculation notes and drawings are prepared taking account of the loads to be anchored. The position of the anchor is indicated on the design drawings (e.g. position of the anchor relative to reinforcement or to supports, etc.)
- The strength class and the length of the fastening screw or threaded rod shall be defined by the designing engineer
- Anchorages are designed acc. to EN 1992-4:2018 (if necessary in connection with TR 055)

### Installation:

- Anchor installation in accordance with the manufacturer's specifications and drawings and using the appropriate tools
- Drill hole by hammer drilling or vacuum drilling

**Drop-in Anchor E / ES**

**Intended use**  
Specifications

**Annex B2**

**Table B1: Installation parameters for  $h_{ef} \geq 30$  mm**

Anchor size			M6x30	M8x30	M8x40	M10x30	M10x40	M12x50	M16x65
Depth of drill hole E	$h_0 =$	[mm]	30	30	40	30	40	50	65
Depth of drill hole ES	$h_0 \geq$	[mm]	30	30	40	30	40	50	65
Drill hole diameter	$d_0 =$	[mm]	8	10	10	12	12	15	20
Cutting diameter of drill bit	$d_{cut} \leq$	[mm]	8,45	10,45	10,45	12,5	12,5	15,5	20,55
Maximum installation torque	$T_{inst} \leq$	[Nm]	4	8	8	15	15	35	60
Diameter of clearance hole in the fixture	$d_f \leq$	[mm]	7	9	9	12	12	14	18
Thread length	$L_{th}$	[mm]	13	13	20	12	15	18	23
Minimum screw-in depth	$L_{sdmin}$	[mm]	7	9	9	10	11	13	18
<b>Steel, zinc plated</b>									
Minimum thickness of member	$h_{min}$	[mm]	100	100	100	120	120	130	160
Minimum spacing	$s_{min}$	[mm]	55	60	80	100	100	120	150
Minimum distance	$c_{min}$	[mm]	95	95	95	115	135	165	200
<b>Stainless steel A4, HCR</b>									
Minimum thickness of member	$h_{min}$	[mm]	100	100	100	-	130	140	160
Minimum spacing	$s_{min}$	[mm]	50	60	80	-	100	120	150
Minimum distance	$c_{min}$	[mm]	80	95	95	-	135	165	200

**Table B2: Installation parameters for  $h_{ef} = 25$  mm**

Anchor size			M6x25	M8x25	M10x25	M12x25
Depth of drill hole	$h_0 \geq$	[mm]	25	25	25	25
Drill hole diameter	$d_0 =$	[mm]	8	10	12	15
Cutting diameter of drill bit	$d_{cut} \leq$	[mm]	8,45	10,45	12,5	15,5
Maximum installation torque	$T_{inst} \leq$	[Nm]	4	8	15	35
Diameter of clearance hole in the fixture	$d_f \leq$	[mm]	7	9	12	14
Thread length	$L_{th}$	[mm]	12	12	12	12
Minimum screw-in depth	$L_{sdmin}$	[mm]	6	8	10	12
<b>Minimum thickness of member</b>	$h_{min,1}$	[mm]	<b>80</b>			
Minimum spacing	$s_{min}$	[mm]	30	70	70	100
Minimum edge distance	$c_{min}$	[mm]	60	100	100	130
<b>Standard thickness of member</b>	$h_{min,2}$	[mm]	<b>100</b>			
Minimum spacing	$s_{min}$	[mm]	30	50	60	100
Minimum edge distance	$c_{min}$	[mm]	60	100	100	110
<b>Installation in precast pre-stressed hollow core slabs C30/37 to C50/60</b>						
Spacing	$s_{min}$	[mm]	200			
Edge distance	$c_{min}$	[mm]	150			

**Drop-in Anchor E / ES**

 Intended use  
 Installation parameters

**Annex B3**

## Admissible anchor positions in precast pre-stressed hollow core slabs ( $w / e \leq 4,2$ )

Core distance:  
 $l_c \geq 100 \text{ mm}$

Pre-stressing steel distance:  
 $l_p \geq 100 \text{ mm}$

Distance between anchor position and pre-stressing steel:  
 $a_p \geq 50 \text{ mm}$

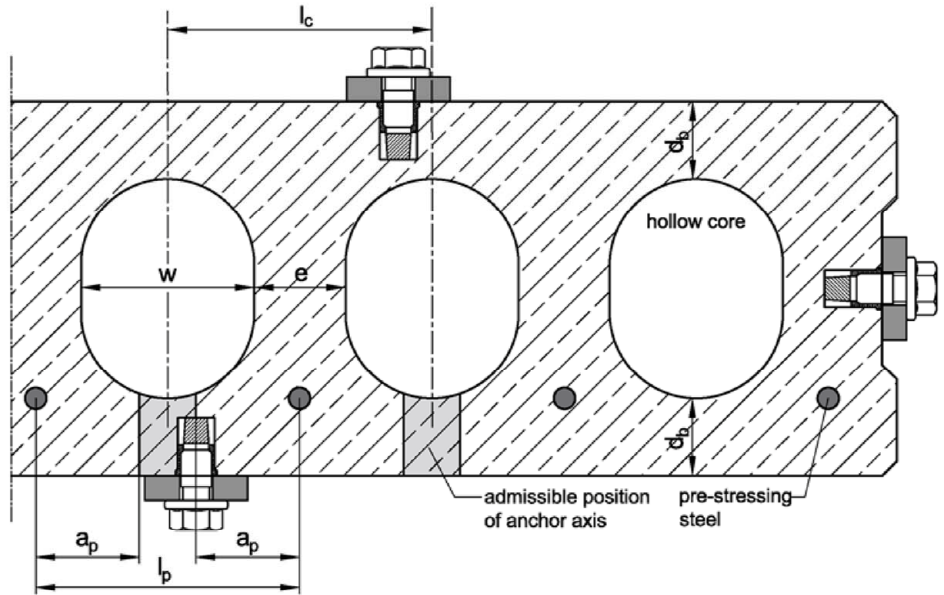

## Minimum spacing and edge distance of anchors and distance in precast pre-stressed hollow core slabs

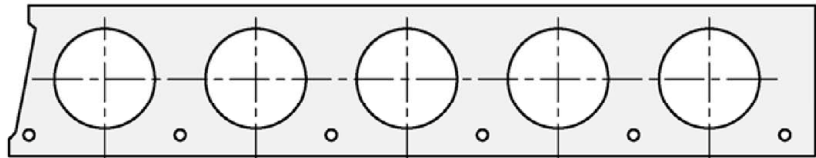

Minimum edge distance  
 $c_{min} \geq 150 \text{ mm}$

Minimum spacing  
 $s_{min} \geq 200 \text{ mm}$

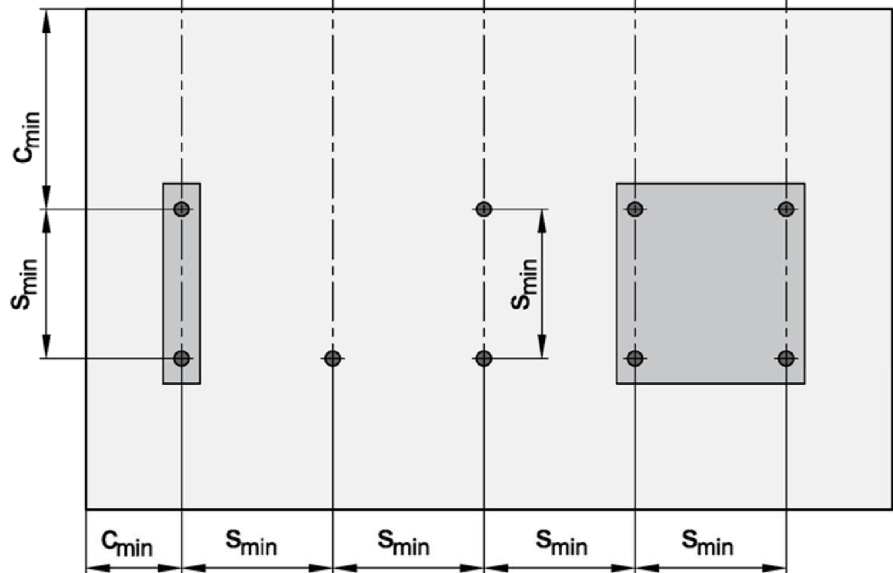

### Drop-in Anchor E / ES

**Intended use**  
 Installation in precast pre-stressed hollow core slabs

**Annex B4**

## Installation instructions for solid concrete slabs

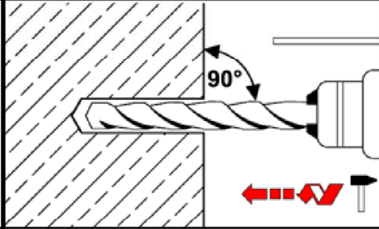
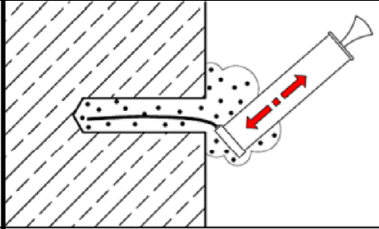
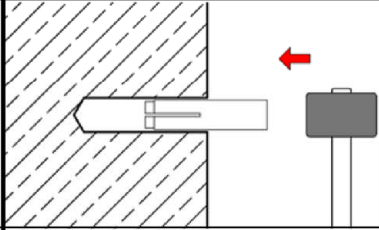
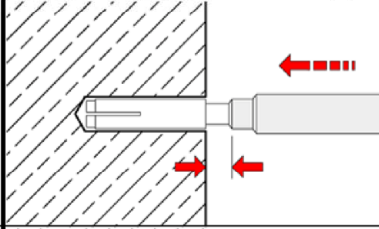
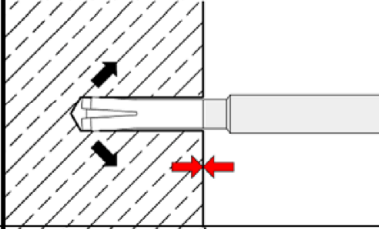
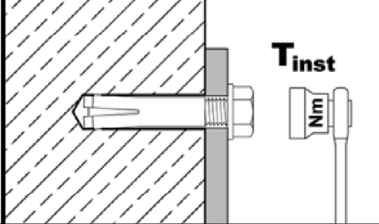
1		<p>Drill hole perpendicular to concrete surface. Using vacuum drill bit proceed with step 3.</p>
2		<p>Blow out dust. Alternatively, vacuum clean down to the bottom of the hole.</p>
3		<p>Drive in anchor.</p>
4		<p>Drive in cone by using setting tool.</p>
5		<p>Shoulder of setting tool must fit on anchor rim.</p>
6		<p>Turn in screw or threaded rod with nut, observe minimum screw-in depth (see Annex B3). Apply installation torque <math>T_{inst}</math>.</p>

### Drop-in Anchor E / ES

**Intended use**  
Installation instructions for solid concrete slabs

**Annex B5**

## Installation instructions for precast pre-stressed hollow core slabs

1		Search for the position of the reinforcement.
2		Mark the position of the pre-stressing steel and search for the other position of the pre-stressing steel.
3		Mark the positions of next pre-stressing steel.
4		Drill hole while maintaining the required distances.
5		Blow out dust. Alternatively vacuum clean down to the bottom of the hole.
6		Drive in anchor.
7		Drive in cone by using setting tool.
8		Shoulder of setting tool must fit on anchor rim.
9		Turn in screw or threaded rod with nut, observe the minimum screw-in depth (see Annex B3). Apply installation torque $T_{inst}$ .

### Drop-in Anchor E / ES

**Intended use**  
Installation instructions for precast pre-stressed hollow core slabs

**Annex B6**

**Table C1: Characteristic resistance for  $h_{ef} \geq 30$  mm in solid concrete slabs**

Anchor size			M6x30	M8x30	M8x40	M10x30	M10x40	M12x50	M16x65
Installation factor	$\gamma_{inst}$	[-]	1,0						
<b>Load in any direction</b>									
Characteristic resistance in concrete <b>C20/25 to C50/60</b>	$F_{Rk}^0$	[kN]	3	5	6	6	6	6	16
Partial factor	$\gamma_M^{1)}$	[-]	1,8	2,16		2,1	2,16	1,8	1,8
Spacing	$s_{cr}$	[mm]	130	180	210	230	170	170	400
Edge distance	$c_{cr}$	[mm]	65	90	105	115	85	85	200
<b>Shear load with lever arm, steel zinc plated</b>									
Characteristic resistance <b>(Steel 4.6)</b>	$M_{Rk,s}^0$	[Nm]	6,1	15	15	30	30	52	133
Partial factor	$\gamma_{Ms}^{1)}$	[-]	1,67						
Characteristic resistance <b>(Steel 4.8)</b>	$M_{Rk,s}^0$	[Nm]	6,1	15	15	30	30	52	133
Partial factor	$\gamma_{Ms}^{1)}$	[-]	1,25						
Characteristic resistance <b>(Steel 5.6)</b>	$M_{Rk,s}^0$	[Nm]	7,6	19	19	37	37	65	166
Partial factor	$\gamma_{Ms}^{1)}$	[-]	1,67						
Characteristic resistance <b>(Steel 5.8)</b>	$M_{Rk,s}^0$	[Nm]	7,6	19	19	37	37	65	166
Partial factor	$\gamma_{Ms}^{1)}$	[-]	1,25						
Characteristic resistance <b>(Steel 8.8)</b>	$M_{Rk,s}^0$	[Nm]	12	30	30	59	60	105	266
Partial factor	$\gamma_{Ms}^{1)}$	[-]	1,25						
<b>Shear load with lever arm, stainless steel A4 / HCR</b>									
Characteristic resistance <b>(Property class 70)</b>	$M_{Rk,s}^0$	[Nm]	11	26	26	- <sup>2)</sup>	52	92	233
Partial factor	$\gamma_{Ms}^{1)}$	[-]	1,56						
Characteristic resistance <b>(Property class 80)</b>	$M_{Rk,s}^0$	[Nm]	12	30	30	- <sup>2)</sup>	60	105	266
Partial factor	$\gamma_{Ms}^{1)}$	[-]	1,33						

<sup>1)</sup> in absence of other national regulations

<sup>2)</sup> Anchor version is not part of the ETA

**Drop-in Anchor E / ES**

**Performance**  
Characteristic resistance for  $h_{ef} \geq 30$  mm in **solid concrete**

**Annex C1**



**Table C2: Characteristic resistance for  $h_{ef} = 25$  mm in solid concrete slabs**

Anchor size			M6x25	M8x25	M10x25	M12x25
Installation factor	$\gamma_{inst}$	[-]	1,0			
<b>Load in any direction</b>						
Characteristic resistance in concrete <b>C12/15 and C16/20</b>	$F^0_{RK}$	[kN]	2,5	2,5	3,5	3,5
Characteristic resistance in concrete <b>C20/25 to C50/60</b>	$F^0_{RK}$	[kN]	3,5	4,0	4,5	4,5
Partial factor	$\gamma_M^{1)}$	[-]	1,5			
Spacing	$s_{cr}$	[mm]	75	75	75	75
Edge distance	$c_{cr}$	[mm]	38	38	38	38
<b>Shear load with lever arm</b>						
Characteristic resistance <b>(Steel 4.6)</b>	$M^0_{RK,s}$	[Nm]	6,1	15	30	52
Partial factor	$\gamma_{Ms}^{1)}$	[-]	1,67			
Characteristic resistance <b>(Steel 4.8)</b>	$M^0_{RK,s}$	[Nm]	6,1	15	30	52
Partial factor	$\gamma_{Ms}^{1)}$	[-]	1,25			
Characteristic resistance <b>(Steel 5.6)</b>	$M^0_{RK,s}$	[Nm]	7,6	19	37	65
Partial factor	$\gamma_{Ms}^{1)}$	[-]	1,67			
Characteristic resistance <b>(Steel 5.8)</b>	$M^0_{RK,s}$	[Nm]	7,6	19	37	65
Partial factor	$\gamma_{Ms}^{1)}$	[-]	1,25			
Characteristic resistance <b>(Steel 8.8)</b>	$M^0_{RK,s}$	[Nm]	12	30	60	105
Partial factor	$\gamma_{Ms}^{1)}$	[-]	1,25			

<sup>1)</sup> in absence of other national regulations

**Drop-in Anchor E / ES**

**Performance**  
Characteristic resistance for  $h_{ef} = 25$  mm in **solid concrete**

**Annex C2**

**Table C3: Characteristic resistance for  $h_{ef} = 25$  mm in precast pre-stressed hollow core slabs**

Anchor size			M6x25	M8x25	M10x25	M12x25
Installation factor	$\gamma_{inst}$	[-]	1,0			
<b>Load in any direction</b>						
Flange thickness	$d_b$	[mm]	$\geq 35$ (30) <sup>1)</sup>			
Characteristic resistance in precast pre-stressed hollow core slabs <b>C30/37 to C50/60</b>	$F^{0}_{RK}$	[kN]	3,5	4,0	4,5	4,5
Partial factor	$\gamma_{M^2)}$	[-]	1,5			
Spacing	$s_{cr}$	[mm]	200			
Edge distance	$c_{cr}$	[mm]	150			
<b>Shear load with lever arm</b>						
Characteristic resistance <b>(Steel 4.6)</b>	$M^{0}_{RK,s}$	[Nm]	6,1	15	30	52
Partial factor	$\gamma_{Ms^2)}$	[-]	1,67			
Characteristic resistance <b>(Steel 4.8)</b>	$M^{0}_{RK,s}$	[Nm]	6,1	15	30	52
Partial factor	$\gamma_{Ms^2)}$	[-]	1,25			
Characteristic resistance <b>(Steel 5.6)</b>	$M^{0}_{RK,s}$	[Nm]	7,6	19	37	65
Partial factor	$\gamma_{Ms^2)}$	[-]	1,67			
Characteristic resistance <b>(Steel 5.8)</b>	$M^{0}_{RK,s}$	[Nm]	7,6	19	37	65
Partial factor	$\gamma_{Ms^2)}$	[-]	1,25			
Characteristic resistance <b>(Steel 8.8)</b>	$M^{0}_{RK,s}$	[Nm]	12	30	60	105
Partial factor	$\gamma_{Ms^2)}$	[-]	1,25			

<sup>1)</sup> the anchor may be set in a flange thickness of 30 mm with identical characteristic loads, if the borehole cuts no hollow core

<sup>2)</sup> in absence of other national regulations

**Drop-in Anchor E / ES**

**Performance**

Characteristic resistance for  $h_{ef} = 25$  mm in **precast pre-stressed hollow core slabs**

**Annex C3**

**Table C4: Characteristic values under fire exposure in solid concrete slabs  
C20/25 to C50/60 for  $h_{ef} \geq 30$  mm**

Anchor size				M6x30	M8x30	M8x40	M10x30	M10x40	M12x50	M16x65	
<b>Fire resistance class</b>		<b>Load in any direction</b>									
Steel 4.6	R 30	Characteristic resistance	$F^{0}_{Rk,fi}$	[kN]	0,4	0,6	0,6	0,9	0,9	1,5	3,1
	R 60			[kN]	0,35	0,6	0,6	0,8	0,8	1,3	2,4
	R 90			[kN]	0,3	0,6	0,6	0,6	0,6	1,1	2,0
	R 120			[kN]	0,25	0,5	0,5	0,5	0,5	0,8	1,6
Steel 4.8	R 30	Characteristic resistance	$F^{0}_{Rk,fi}$	[kN]	0,4	0,9	1,1	0,9	1,5	1,5	4,0
	R 60			[kN]	0,35	0,9	0,9	0,9	1,5	1,5	4,0
	R 90			[kN]	0,3	0,6	0,6	0,9	1,1	1,5	3,0
	R 120			[kN]	0,3	0,5	0,5	0,7	0,9	1,2	2,4
Steel $\geq 5.6$	R 30	Characteristic resistance	$F^{0}_{Rk,fi}$	[kN]	0,8	0,9	1,5	0,9	1,5	1,5	4,0
	R 60			[kN]	0,8	0,9	1,5	0,9	1,5	1,5	4,0
	R 90			[kN]	0,4	0,9	0,9	0,9	1,5	1,5	3,7
	R 120			[kN]	0,3	0,5	0,5	0,7	1,0	1,2	2,4
A4 / HCR	R 30	Characteristic resistance	$F^{0}_{Rk,fi}$	[kN]	0,8	0,9	1,5	<sup>-1)</sup>	1,5	1,5	4,0
	R 60			[kN]	0,8	0,9	1,5	<sup>-1)</sup>	1,5	1,5	4,0
	R 90			[kN]	0,4	0,9	0,9	<sup>-1)</sup>	1,5	1,5	3,7
	R 120			[kN]	0,3	0,5	0,5	<sup>-1)</sup>	1,0	1,2	2,4
Partial factor			$\gamma_{M,fi}$	[-]	1,0						
<b>Steel zinc plated</b>											
		Spacing	$S_{cr,fi}$	[mm]	130	180	210	170	170	200	400
R 30 – R 120		Edge distance	$C_{cr,fi}$	[mm]	65	90	105	85	85	100	200
If the fire attack is from more than one side, the edge distance shall be $\geq 300$ mm.											
<b>Stainless steel A4, HCR</b>											
		Spacing	$S_{cr,fi}$	[mm]	130	180	210	<sup>-1)</sup>	170	200	400
R 30 – R 120		Edge distance	$C_{cr,fi}$	[mm]	65	90	105	<sup>-1)</sup>	85	100	200
If the fire attack is from more than one side, the edge distance shall be $\geq 300$ mm.											

<sup>1)</sup> Anchor version is not part of the ETA

**Drop-in Anchor E / ES**

**Performance**  
Characteristic values under **fire exposure** for  $h_{ef} \geq 30$  mm

**Annex C4**

**Table C5: Characteristic values under fire exposure in solid concrete slabs  
C20/25 to C50/60 for  $h_{ef} = 25$  mm**

Anchor size				M6x25	M8x25	M10x25	M12x25		
<b>Fire resistance class</b>		<b>Load in any direction</b>							
Steel $\geq 4.6$	R 30	Characteristic resistance	$F^{0}_{RK,fi}$	[kN]	0,4	0,6	0,6	0,6	
	R 60			[kN]	0,35	0,6	0,6	0,6	
	R 90			[kN]	0,3	0,6	0,6	0,6	
	R 120			[kN]	0,25	0,5	0,5	0,5	
Partial factor			$\gamma_{M,fi}$	[-]				1,0	
Spacing			$s_{cr,fi}$	[mm]	100	100	100	100	
R 30 – R 120			Edge distance	$c_{cr,fi}$	[mm]	50	50	50	50
If the fire attack is from more than one side, the edge distance shall be $\geq 300$ mm.									

**Drop-in Anchor E / ES**

**Performance**  
Characteristic values under **fire exposure** for  $h_{ef} = 25$  mm

**Annex C5**