

## DICHIARAZIONE DI PRESTAZIONE

DoP No. MKT-161 - it

- ✧ **Codice di identificazione unico del prodotto-tipo:** **Ancorante SLZ per carichi pesanti**
- ✧ **Usi previsti:** Tasselli ad espansione a forza controllata (acciaio zincato) nella misura 14 / M10 per ancoraggio nel calcestruzzo, vedi allegato B /Annex B
- ✧ **Fabbricante:** MKT Metall-Kunststoff-Technik GmbH & Co.KG  
Auf dem Immel 2  
67685 Weilerbach
- ✧ **Sistema o sistemi di valutazione e verifica della costanza della prestazione:** 1
- ✧ **Documento per la valutazione europea:** **EAD 330232-00-0601**  
Valutazione tecnica europea: **ETA-09/0342, 01.03.2018**  
Organismo di valutazione tecnica: **DIBt, Berlin**  
Organismi notificati: **NB 1343 – MPA, Darmstadt**

✧ **Prestazioni dichiarate:**

Caratteristiche essenziali	Prestazione
<b>Resistenza meccanica e stabilità (BWR 1)</b>	
Resistenze caratteristiche (effetti statici e quasi statici), Turni	Allegato / Annex C1 – C2
<b>Sicurezza in caso di incendio (BWR 2)</b>	
Comportamento al fuoco	Classe A1
Resistenza al fuoco	Allegato / Annex C3

La prestazione del prodotto sopra identificato è conforme all'insieme delle prestazioni dichiarate. La presente dichiarazione di responsabilità viene emessa, in conformità al regolamento (EU) n. 305/2011, sotto la sola responsabilità del fabbricante sopra identificato.

Firmato a nome e per conto del fabbricante da:

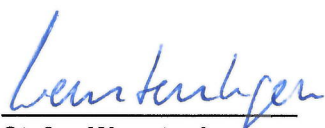

**Stefan Weustenhagen**  
(Direttore Generale)  
**Weilerbach, 01.03.2018**

p.p.

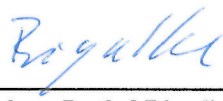

**Dipl.-Ing. Detlef Bigalke**  
(Direttore del Sviluppo del Prodotto)



L'originale di questa dichiarazione di prestazione è stata scritta in tedesco. In caso di deviazioni nella traduzione, la versione tedesca è valida.

## Specifications of intended use

### Anchorage subject to:

- Static or quasi-static action
- fire exposure

### Base materials:

- Reinforced or unreinforced normal weight concrete according to EN 206-1:2000
- Strength classes C20/25 to C50/60 according to EN 206-1:2000
- Cracked and uncracked concrete

### Use conditions (Environmental conditions):

- Structures subject to dry internal conditions (zinc plated steel).

### Design:

- Anchorages are designed under the responsibility of an engineer experienced in anchorages and concrete work.
- Verifiable calculation notes and drawings are prepared taking account of the loads to be anchored. The position of the anchor is indicated on the design drawings (e.g. position of the anchor relative to reinforcement or to supports, etc.).
- Anchorages are designed according to FprEN 1992-4: 2016 and TR 055.

### Installation:

- Anchor installation carried out by appropriately qualified personnel and under the supervision of the person responsible for technical matters of the site.
- Positioning of the drill holes without damaging the reinforcement
- In case of aborted hole: new drilling at a minimum distance away of twice the depth of the aborted hole or smaller distance if the aborted drill hole is filled with high strength mortar and if under shear or oblique tension load it is not in the direction of load application.
- Anchor installation such that the effective anchorage depth is complied with. This compliance is ensured, when the embedment mark of the anchor does no more exceed the concrete surface
- Drilling by hammer drill bit (use of vacuum drill bit is admissible)

## Highload Anchor SLZ

Intended use  
Specifications

Annex B1

## Installation instructions

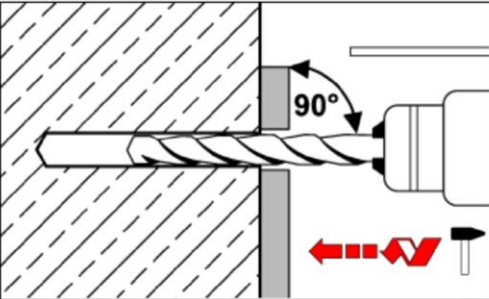
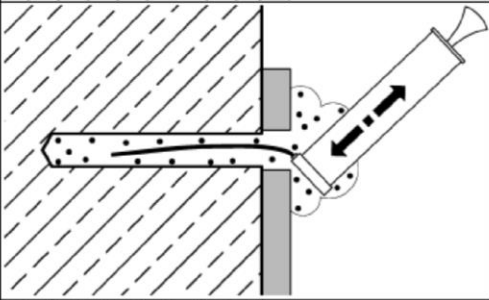
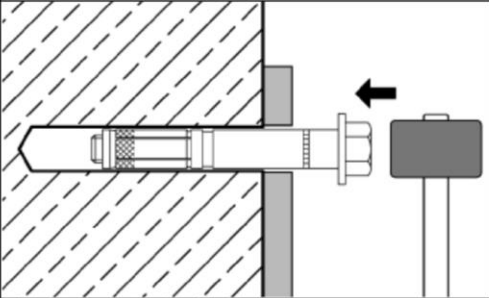
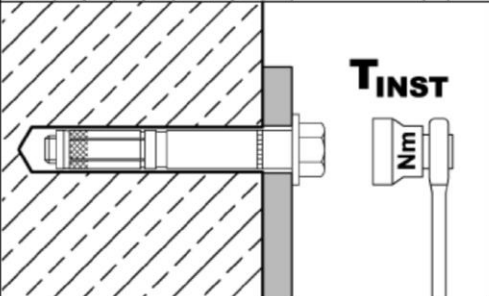
1		<p>Drill hole perpendicular to concrete surface. Using a vacuum drill bit, proceed with step 3.</p>
2		<p>Blow out dust. Alternatively vacuum clean down to the bottom of the hole.</p>
3		<p>Drive in anchor.</p>
4		<p>Apply tightening torque <math>T_{inst}</math> by using torque wrench.</p>

### Highload Anchor SLZ

Intended use  
Installation instructions

Annex B2

**Table B1: Installation parameters**

Anchor size			14/M10
Size of thread			M10
Effective anchorage depth	$h_{ef}$	[mm]	65
Nominal diameter of drill bit	$d_0$	[mm]	14
Cutting diameter of drill bit	$d_{cut} \leq$	[mm]	14,5
Depth of drill hole	$h_1 \geq$	[mm]	85
Diameter of clearance hole in the fixture mounted on distance sleeve	$d_f \leq$	[mm]	16
Diameter of clearance hole in the fixture mounted on threaded bolt	$d_f \leq$	[mm]	12
Installation torque	$T_{inst}$	[Nm]	50
Minimum thickness of member	$h_{min}$	[mm]	130
Minimum spacing	$s_{min}$	[mm]	60
	$c \geq$	[mm]	120
Minimum edge distance	$c_{min}$	[mm]	70
	$s \geq$	[mm]	130

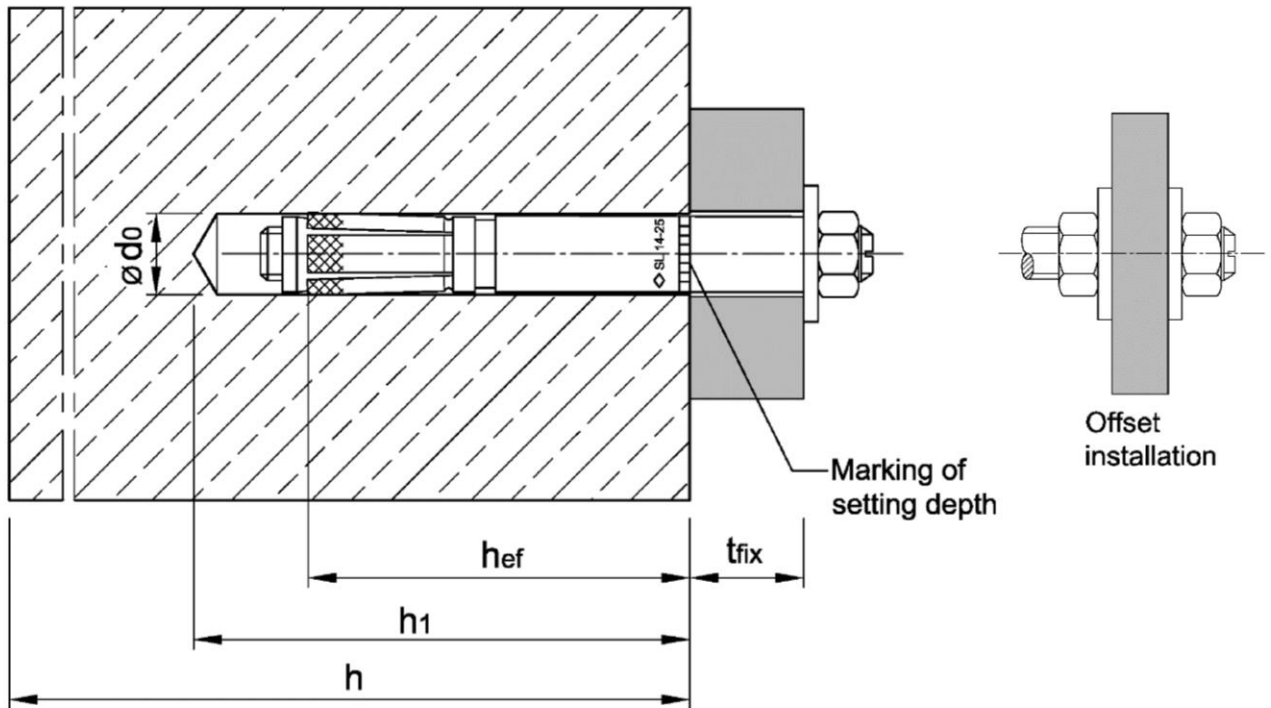

**Highload Anchor SLZ**

**Intended use**  
Installation parameters

**Annex B3**

**Table C1: Characteristic values for tension loads**

<b>Anchor size</b>			<b>14/M10</b>
Installation safety factor	$\gamma_{inst}$	[-]	1,0
<b>Steel failure</b>			
Characteristic resistance	$N_{RK,s}$	[kN]	46
Partial safety factor	$\gamma_{Ms}$	[-]	1,5
<b>Pull-out failure</b>			
Characteristic resistance in cracked concrete C20/25	$N_{RK,p}$	[kN]	12
Characteristic resistance in uncracked concrete C20/25	$N_{RK,p}$	[kN]	20
Increasing factors for $N_{RK,p}$	$\psi_C$	[-]	$\left(\frac{f_{ck}}{20}\right)^{0,5}$
<b>Concrete cone failure</b>			
Effective Anchorage depth	$h_{ef}$	[mm]	65
Spacing	$s_{cr,N}$	[mm]	3 $h_{ef}$
Edge distance	$c_{cr,N}$	[mm]	1,5 $h_{ef}$
Factor $k_1$ for cracked concrete	$k_{cr,N}$	[-]	7,7
Factor $k_1$ for uncracked concrete	$k_{ucr,N}$	[-]	11,0
<b>Splitting failure</b>			
Characteristic resistance in uncracked concrete	$N^0_{RK,sp}$	[kN]	min [ $N_{RK,p}; N^0_{RK,c}$ ]
Spacing	$s_{cr,sp}$	[mm]	390
Edge distance	$c_{cr,sp}$	[mm]	195

**Table C2: Displacements under tension loads**

<b>Anchor size</b>			<b>14/M10</b>
Tension load in cracked concrete	N	[kN]	5,7
Displacement	$\delta_{N0}$	[mm]	0,8
	$\delta_{N\infty}$	[mm]	1,5
Tension load in uncracked concrete	N	[kN]	9,5
Displacement	$\delta_{N0}$	[mm]	0,3
	$\delta_{N\infty}$	[mm]	1,2

**Highload Anchor SLZ**

**Performance**  
 Characteristic values and displacements under **tension load**

**Annex C1**

**Table C3: Characteristic values for shear loads**

<b>Anchor size</b>			<b>14/M10</b>
<b>Steel failure without lever arm</b>			
Characteristic resistance, fixture mounted on distance sleeve with $t_{fix} \leq 75$ mm	$V_{RK,s}^0$	[kN]	32,8
Characteristic resistance, fixture mounted on distance sleeve with $t_{fix} > 75$ mm	$V_{RK,s}^0$	[kN]	23,2
Factor	$k_7$	[-]	1,0
Partial safety factor	$\gamma_{Ms}$	[-]	1,25
<b>Steel failure with lever arm</b>			
Characteristic resistance	$M_{RK,s}^0$	[Nm]	60
Partial safety factor	$\gamma_{Ms}$	[-]	1,25
<b>Concrete pry-out failure</b>			
Factor	$k_8$	[-]	2,0
<b>Concrete edge failure</b>			
Effective length of anchor in shear loading	$l_f$	[mm]	65
Outside diameter of anchor	$d_{nom}$	[mm]	14

**Table C4: Displacements under shear loads**

<b>Anchor size</b>			<b>14/M10</b>
Shear load in non-cracked concrete	$V$	[kN]	13,2
Displacement	$\delta_{V0}$	[mm]	2,2
	$\delta_{V\infty}$	[mm]	3,3

**Highload Anchor SLZ**

**Performance**  
 Characteristic values and displacements under **shear load**

**Annex C2**

**Table C5: Characteristic values under fire exposure in concrete C20/25 to C50/60**

<b>Anchor size</b>			<b>14/M10</b>	
<b>Tension load</b>				
<b>Steel failure</b>				
Characteristic resistance	R30	$N_{Rk,s,fi}$	[kN]	0,9
	R60			0,8
	R90			0,6
	R120			0,5
<b>Shear load</b>				
<b>Steel failure without lever arm</b>				
Characteristic resistance	R30	$V_{Rk,s,fi}$	[kN]	0,9
	R60			0,8
	R90			0,6
	R120			0,5
<b>Steel failure with lever arm</b>				
Characteristic resistance	R30	$M^0_{Rk,s,fi}$	[Nm]	1,1
	R60			1,0
	R90			0,7
	R120			0,6

**Highload Anchor SLZ**

**Performance**  
Characteristic values under **fire exposure**

**Annex C3**