

## VYHLÁSENIE O PARAMETROCH

DoP č.: MKT-451 – sk

- ✧ **Jedinečný identifikačný kód typu výrobku:** Vstrekovací systém VM-EA
- ✧ **Zamýšľané použitie/použitia:** Lepené kotvy na ukotvenie do betón bez trhlín, vid' príloha / Annex B
- ✧ **Výrobca:** MKT Metall-Kunststoff-Technik GmbH & Co.KG  
Auf dem Immel 2  
67685 Weilerbach
- ✧ **Systém (y) na hodnotenie a overovanie stálosti úžitkových vlastností:** 1
- ✧ **Európsky hodnotiaci dokument:** EAD 330499-01-0601  
Európske technické posúdenie: ETA-16/0898, 25.04.2020  
Orgán technického posudzovania: TZÚS, Prag  
Notifikovaný(-é) subjekt(-y): NB 1343 – MPA, Darmstadt

✧ **Deklarované parametre:**

Podstatné vlastnosti	Parametre
<b>Mechanická odolnosť a stabilita (BWR 1)</b>	
Charakteristické odpory pri ťahovom zaťažení (statické a kvázistatické účinky)	Príloha / Annex C1, C2, C4
Charakteristické odpory pri priečnom namáhaní (statické a kvázistatické účinky)	Príloha / Annex C1, C3, C5
Posuny	Príloha / Annex C6
Trvanlivosť	Príloha / Annex B1
<b>Hygiena, zdravie a životné prostredie (BWR 3)</b>	
Obsah, emisie a / alebo uvoľňovanie nebezpečných látok	Výkon nie je hodnotený

Výkonnosť vyššie uvedeného produktu je deklarovaná úžitková vlastnosť / výkon. Uvedený výrobca je zodpovedný výlučne za vypracovanie vyhlásenia o úžitkových vlastnostiach v súlade s nariadením (EÚ) č. 305/2011.

Podpísal(-a) za a v mene výrobcu:

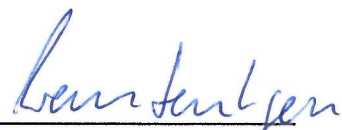
  
**Stefan Weustenhagen**  
(Generálny riaditeľ)

Weilerbach, 25.04.2020

p.p.   
**Dipl.-Ing. Detlef Bigalke**  
(Vedúci vývoja produktov)



Originál tohto vyhlásenia o úžitkových vlastnostiach bol napísaný v nemčine. Pre odchýlky v preklade platí nemecká verzia.

### Installation threaded rod M8 to M24

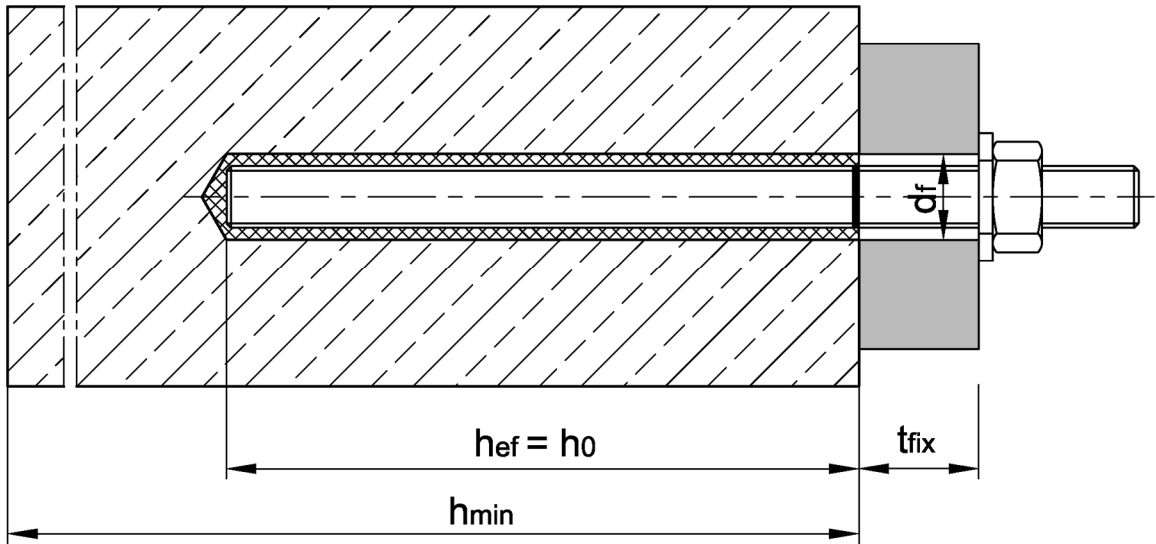

### Installation internally threaded anchor rod VMU-IG M6 to M16

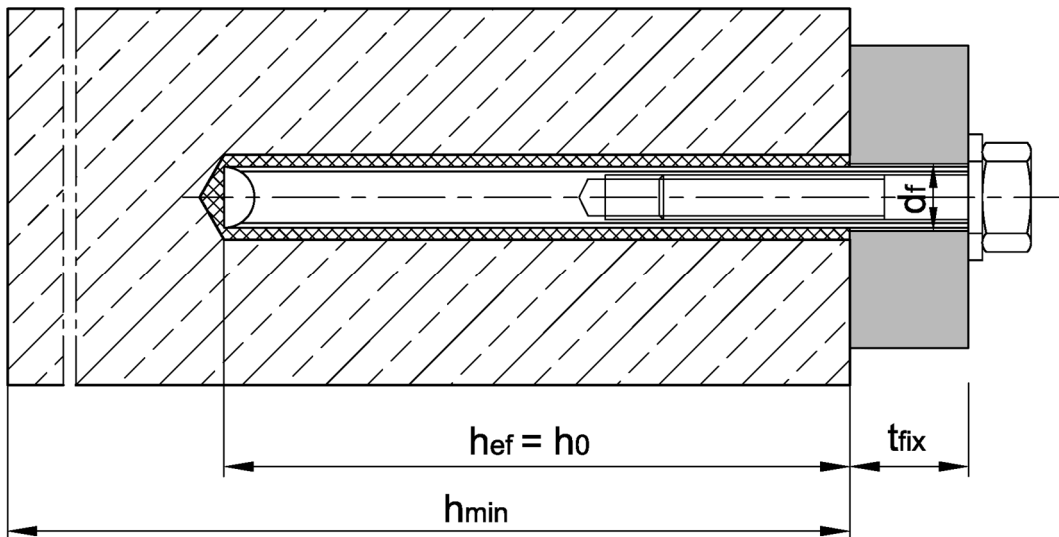

- $t_{fix}$  = thickness of fixture
- $d_f$  = diameter of clearance hole in the fixture
- $h_{ef}$  = effective embedment depth
- $h_o$  = depth of drill hole
- $h_{min}$  = minimum thickness of member

**Injection System VM-EA for concrete**

**Product description**  
Installation conditions

**Annex A1**

**Cartridge: VM-EA, VM-EA blue, VM-EA express, VM-EA low speed**

**150 ml, 280 ml, 300 ml up to 330 ml and 380 ml up to 420 ml cartridge (Type: coaxial)**

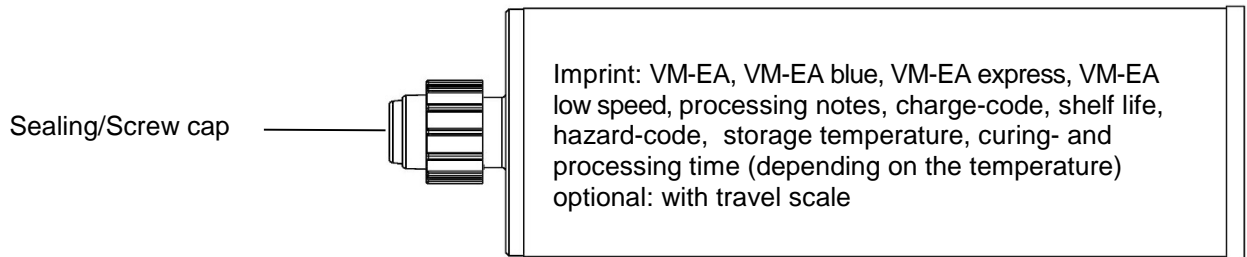

**235 ml, 345 ml up to 360 ml and 825 ml cartridge (Type: “side-by-side”)**

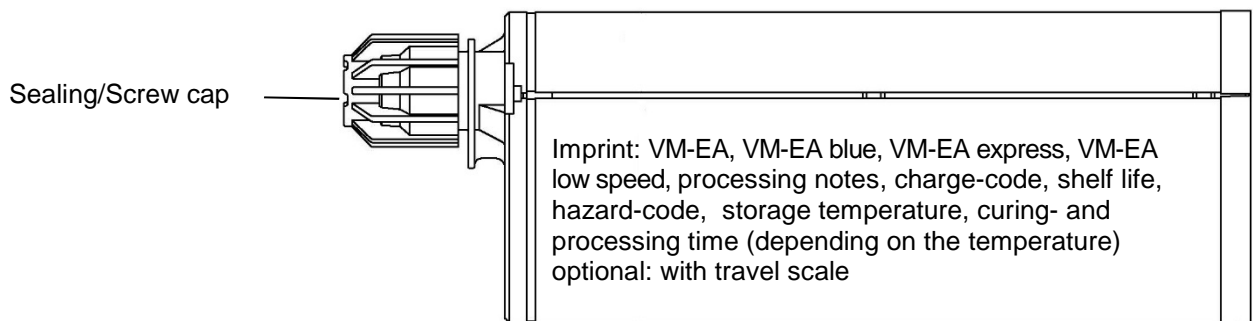

**165 ml and 300 ml cartridge (Type: “foil tube”)**

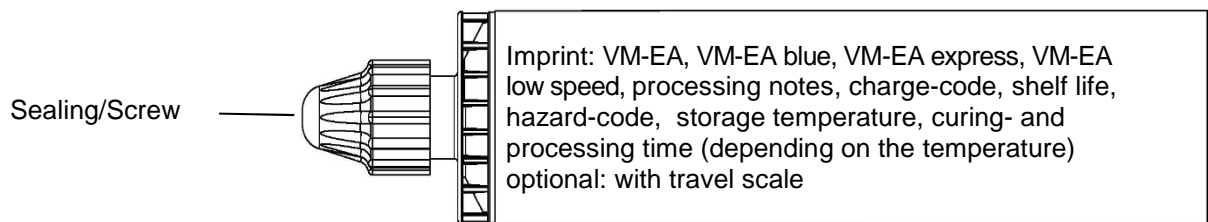

**Static mixer**

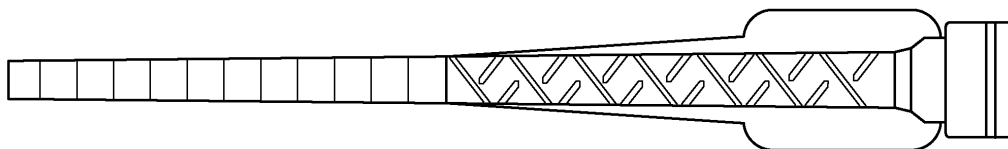

**Injection System VM-EA for concrete**

**Product description**  
Injection system

**Annex A2**

## Threaded rod

**Threaded rod VMU-A, V-A with washer and hexagon nut**  
**M8, M10, M12, M16, M20, M24** (zinc plated, A4, HCR)

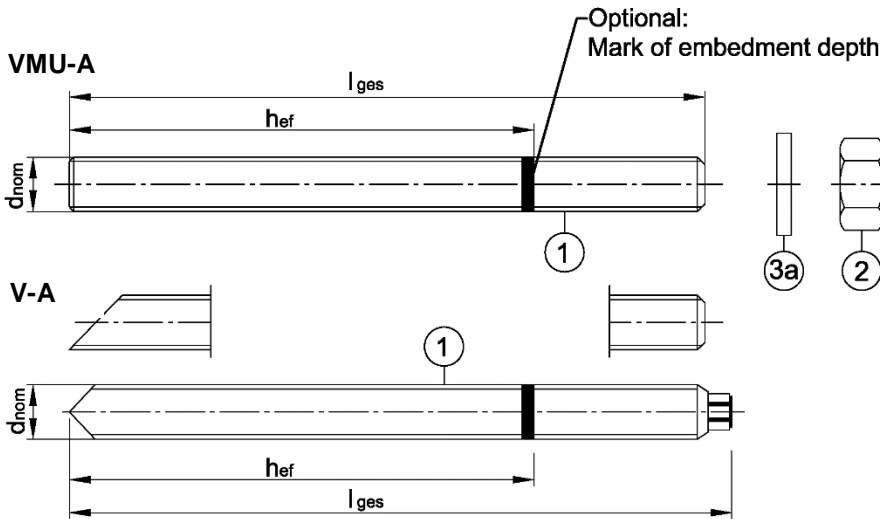

Marking: e.g.  $\diamond$  M10

- $\diamond$  Identifying mark of manufacturing plant
- M10 Size of thread
- A4 additional marking for stainless steel
- HCR additional marking for High corrosion resistant steel

**Threaded rod VM-A** (material sold by the metre, to be cut at the required length)  
**M8, M10, M12, M16, M20, M24** (zinc plated, A2, A4, HCR)

**Commercial standard threaded rod with:**

**M8, M10, M12, M16, M20, M24** (zinc plated, A2, A4, HCR)

- Materials, dimensions and mechanical properties see Table A1
- Inspection certificate 3.1 acc. to EN 10204:2004

## Internally threaded anchor rod

**VMU-IG M6, VMU-IG M8, VMU-IG M10, VMU-IG M12, VMU-IG M16**  
(zinc plated, A4, HCR)

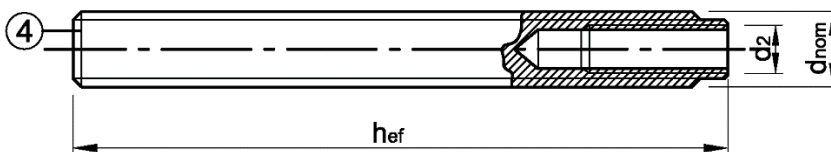

Marking e.g.:  $\diamond$  I M8

- $\diamond$  Identifying mark of manufacturing plant
- I Internal thread
- M8 Size of internal thread
- A4 additional marking for stainless steel
- HCR additional marking for high corrosion resistant steel

**Injection System VM-EA for concrete**

**Product description**

Threaded rod and internally threaded anchor rod

**Annex A3**

**Table A1: Materials**

Part	Designation	Material				
<b>Steel, zinc plated</b> electroplated $\geq 5 \mu\text{m}$ acc. to EN ISO 4042:1999 or hot-dip galvanized $\geq 45 \mu\text{m}$ acc. to EN ISO 1461:2009, EN ISO 10684:2004+AC:2009 or sherardized $\geq 45 \mu\text{m}$ acc. to EN ISO 17668:2016						
1	Threaded rod	Property class	characteristic steel ultimate strength	characteristic steel yield strength	fracture elongation	EN 10087:1998, EN 10263:2001;  Commercial standard threaded rod: EN ISO 898-1:2013
		4.6	$f_{uk} \geq 400 \text{ N/mm}^2$ ;	$f_{yk} \geq 240 \text{ N/mm}^2$ ;	$A_5 > 8 \%$	
		4.8	$f_{uk} \geq 400 \text{ N/mm}^2$	$f_{yk} \geq 320 \text{ N/mm}^2$	$A_5 > 8 \%$	
		5.6	$f_{uk} \geq 500 \text{ N/mm}^2$	$f_{yk} \geq 300 \text{ N/mm}^2$	$A_5 > 8 \%$	
		5.8	$f_{uk} \geq 500 \text{ N/mm}^2$	$f_{yk} \geq 400 \text{ N/mm}^2$	$A_5 > 8 \%$	
		8.8	$f_{uk} \geq 800 \text{ N/mm}^2$	$f_{yk} \geq 640 \text{ N/mm}^2$	$A_5 > 8 \%$	
2	Hexagon nut	4	for class 4.6 or 4.8 rods			EN ISO 898-2:2012
		5	for class 4.6, 4.8, 5.6 or 5.8 rods			
		8	for class 4.6, 4.8, 5.6, 5.8 or 8.8 rods			
3	Washer	e.g.: EN ISO 887:2006, EN ISO 7089:2000, EN ISO 7093:2000 or EN ISO 7094:2000				
4	Internally threaded anchor rod	5.8	Steel, electroplated or sherardized	$A_5 > 8\%$	EN 10087:1998	
		8.8	Steel, electroplated or sherardized	$A_5 > 8\%$		
<b>Stainless steel A2<sup>1)</sup></b> <b>Stainless steel A4</b> <b>High corrosion resistant steel HCR</b>			(e.g. 1.4301 / 1.4307 / 1.4311 / 1.4567 / 1.4541) (e.g. 1.4401 / 1.4404 / 1.4571 / 1.4578 / 1.4362) (e.g. 1.4529 / 1.4565)			
1	Threaded rod	Property class	characteristic steel ultimate strength	characteristic steel yield strength	fracture elongation	EN 10088-1:2014 EN ISO 3506-1:2009
		50	$f_{uk} = 500 \text{ N/mm}^2$	$f_{yk} = 210 \text{ N/mm}^2$	$A_5 > 8 \%$	
		70	$f_{uk} = 700 \text{ N/mm}^2$	$f_{yk} = 450 \text{ N/mm}^2$	$A_5 > 8 \%$	
		80	$f_{uk} = 800 \text{ N/mm}^2$	$f_{yk} = 600 \text{ N/mm}^2$	$A_5 > 8 \%$	
2	Hexagon nut	50	for class 50 rods			EN 10088-1:2014 EN ISO 3506-2:2009
		70	for class 50 or 70 rods			
		80	for class 50,70 or 80 rods			
3	Washer	e.g.: EN ISO 887:2006, EN ISO 7089:2000, EN ISO 7093:2000 or EN ISO 7094:2000				
4	Internally threaded anchor rod	70	property class 70		$A_5 > 8 \%$	EN 10088-1:2014

<sup>1)</sup> For property classes 50 and 70

<b>Injection System VM-EA for concrete</b>	<b>Annex A4</b>
<b>Product description</b> Materials	

## Specifications of intended use

Injection System VM-EA	Anchor rod	Internally threaded anchor rod
Static or quasi-static action	<b>VMU-A, V-A, VM-A</b> , commercial standard threaded rod M8 – M24 zinc plated, A2, A4, HCR	<b>VMU-IG</b> M6 - M16 electroplated or sherardized, A4, HCR
Base materials	reinforced or unreinforced normal weight concrete acc. to EN 206:2013+A1:2016	
	strength classes acc. to EN 206:2013+A1:2016: C20/25 to C50/60	
	uncracked concrete	
Temperature Range I: 24°C / 40°C	Temperature range from -40°C to +40°C with max. long term temperature +24°C and max. short term temperature +40 °C	
Temperature Range II: 50°C / 80°C	Temperature range from -40°C to +80°C with max. long term temperature +50°C and max. short term temperature +80 °C	

### Use conditions (Environmental conditions):

- Structures subject to dry internal conditions (all materials).
- For all other conditions according to EN 1993-1-4:2006+A1:2015 corresponding to corrosion resistance classes:
  - Stainless steel A2 according to Annex A, Table A3: CRC II
  - Stainless steel A4 according to Annex A, Table A3: CRC III
  - High corrosion resistant steel HCR according to Annex A, Table A3: CRC V
 Steel grades of a higher corrosion resistance class may be used

### Design:

- Verifiable calculation notes and drawings are prepared taking account of the loads to be anchored. The position of the anchor is indicated on the design drawings (e.g. position of the anchor relative to reinforcement or to supports, etc.)
- Anchorages are designed under the responsibility of an engineer experienced in anchorages and concrete work
- Anchorages are designed in accordance with EN 1992-4:2018 or TR 055.

### Concrete condition:

- I1 = installation in dry or wet (water saturated) concrete and use in service in dry or wet concrete
- I2 = installation in water-filled drill holes (not sea water) and use in service in dry or wet concrete

### Installation:

- Hole drilling by hammer or compressed air drill mode
- Anchor installation carried out by appropriately qualified personnel and under the supervision of the person responsible for technical matters of the site

### Installation direction:

- D3 = downward and horizontal and upwards (e.g. overhead) installation

<b>Injection System VM-EA for concrete</b>	<b>Annex B1</b>
<b>Intended use Specifications</b>	

**Table B1: Installation parameters for threaded rod**

Threaded rod			M 8	M 10	M 12	M 16	M 20	M 24
Diameter of threaded rod	$d=d_{nom}$	[mm]	8	10	12	16	20	24
Nominal drill hole diameter	$d_0$	[mm]	10	12	14	18	24	28
Effective anchorage depth	$h_{ef,min}$	[mm]	60	60	70	80	90	96
	$h_{ef,max}$	[mm]	160	200	240	320	400	480
Diameter of clearance hole in the fixture	$d_f \leq$	[mm]	9	12	14	18	22	26
Installation torque	$T_{inst} \leq$	[Nm]	10	20	40	80	120	160
Minimum thickness of member	$h_{min}$	[mm]	$h_{ef} + 30 \text{ mm}$ $\geq 100 \text{ mm}$			$h_{ef} + 2d_0$		
Minimum spacing	$s_{min}$	[mm]	40	50	60	80	100	120
Minimum edge distance	$c_{min}$	[mm]	40	50	60	80	100	120

**Table B2: Installation parameters for internally threaded anchor rod**

Internally threaded anchor rod			VMU-IG M 6	VMU-IG M 8	VMU-IG M 10	VMU-IG M 12	VMU-IG M 16
Inner diameter of threaded rod	$d_2$	[mm]	6	8	10	12	16
Outer diameter of threaded rod <sup>1)</sup>	$d=d_{nom}$	[mm]	10	12	16	20	24
Nominal drill hole diameter	$d_0$	[mm]	12	14	18	24	28
Effective anchorage depth	$h_{ef,min}$	[mm]	60	70	80	90	96
	$h_{ef,max}$	[mm]	200	240	320	400	480
Diameter of clearance hole in the fixture <sup>1)</sup>	$d_f \leq$	[mm]	7	9	12	14	18
Installation torque	$T_{inst} \leq$	[Nm]	10	10	20	40	60
Minimum screw-in depth	$l_{IG}$	[mm]	8	8	10	12	16
Minimum thickness of member	$h_{min}$	[mm]	$h_{ef} + 30 \text{ mm}$ $\geq 100 \text{ mm}$			$h_{ef} + 2d_0$	
Minimum spacing	$s_{min}$	[mm]	50	60	80	100	120
Minimum edge distance	$c_{min}$	[mm]	50	60	80	100	120

<sup>1)</sup> With metric thread acc. to EN 1993-1-8:2005+AC:2009

**Injection System VM-EA for concrete**

**Intended use**  
Installation parameters

**Annex B2**

# Installation instructions

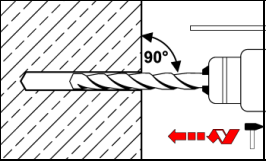
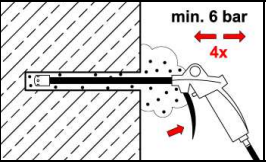
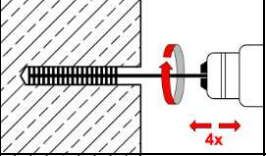
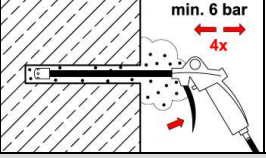
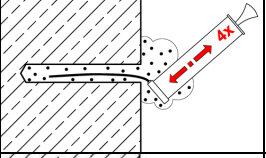
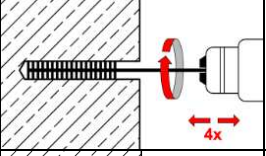
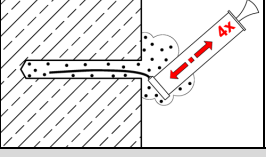
Drilling of the hole		
1.		<p>Drill with hammer drill a hole into the base material to the size required by the selected anchor (Table B1 or B2). In case of aborted drill hole, the drill hole shall be filled with mortar.</p>
Cleaning		
<p><b>Attention! Standing water in the drill hole must be removed before cleaning!</b></p>		
<p><b>Cleaning with compressed air</b> (all diameters)</p>		
2a.		<p>Starting from the bottom or back of the drill hole, blow out the hole with compressed air (min. 6 bar) a minimum of <b>four</b> times. If the drill hole ground is not reached, an extension must be used.</p>
2b.		<p>Attach the brush to a drilling machine or a battery screwdriver. Brush the hole with an appropriate sized wire brush <math>&gt; d_{b,min}</math> (Table B3) a minimum of <b>four</b> times. If the drill hole ground is not reached, a brush extension shall be used.</p>
2c.		<p>Finally blow the hole clean again with compressed air (min. 6 bar) a minimum of <b>four</b> times. If the drill hole ground is not reached an extension shall be used.</p>
2.	<p><b>Manual cleaning</b> Drill hole diameter <math>d_0 \leq 20\text{mm}</math> or drill hole depth <math>h_0 \leq 240\text{mm}</math></p>	
2a.		<p>Starting from the bottom or back of the drill hole, blow the hole clean with the blow-out pump minimum of <b>four</b> times. If the drill hole ground is not reached an extension shall be used.</p>
2b.		<p>Attach the brush to a drilling machine or a battery screwdriver. Brush the hole with an appropriate sized wire brush <math>&gt; d_{b,min}</math> (Table B3) a minimum of <b>four</b> times. If the drill hole ground is not reached, a brush extension shall be used.</p>
2c.		<p>Finally blow the hole clean again with the blow-out pump a minimum of <b>four</b> times. If the drill hole ground is not reached an extension shall be used.</p>
<p><b>After cleaning, the drill hole has to be protected against re-contamination in an appropriate way, until dispensing the mortar in the drill hole. If necessary, the cleaning repeated has to be directly before dispensing the mortar. In-flowing water must not contaminate the drill hole again.</b></p>		

Injection System VM-EA for concrete

Intended use  
Installation instructions

Annex B3

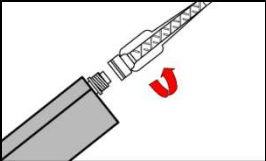
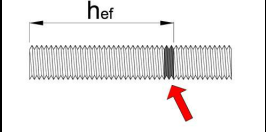
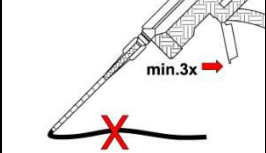
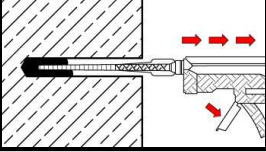
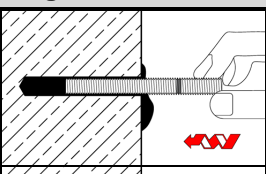
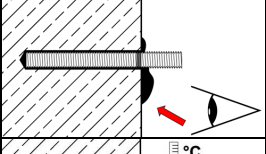
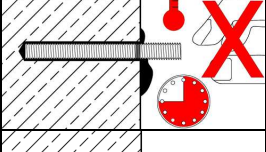
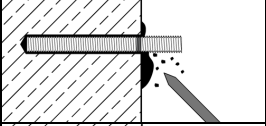
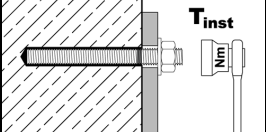

## Installation instructions (continuation)

Injection		
3.		Attach a supplied static-mixing nozzle to the cartridge and load the cartridge into the correct dispensing tool. For foil tube cartridges: cut off the foil tube clip before use. For every working interruption longer than the recommended working time (Table B4) as well as for new cartridges, a new static-mixer shall be used.
4.		Prior to inserting the anchor rod into the filled drill hole, the position of the embedment depth shall be marked on the anchor rod.
5.		Prior to dispensing into the drill hole, squeeze out separately a minimum of three full strokes and discard non-uniformly mixed adhesive components until the mortar shows a consistent grey or blue (VM-EA blue) color. For foil tube cartridges discard a minimum of six full strokes.
6a.		Starting from the bottom or back of the cleaned drill hole fill the hole up to approximately two-thirds with adhesive. Slowly withdraw the static mixing nozzle as the hole fills to avoid air pockets. For embedment larger than 190mm an extension nozzle shall be used. Observe the gel-/ working times given in Table B4.
Inserting the anchor		
7.		Push the threaded rod into the hole while turning slightly to ensure proper distribution of the adhesive until the embedment depth is reached. The anchor shall be free of dirt, grease, oil or other foreign material.
8.		Make sure that the anchor is fully seated up to the full embedment depth and that excess mortar is visible at the top of the hole. If these requirements are not maintained, the application has to be renewed. For overhead installation, the anchor should be fixed (e.g. by wedges).
9.		Allow the adhesive to cure to the specified time prior to applying any load or torque. Do not move or load the anchor until it is fully cured (attend Table B4).
10.		Remove excess mortar.
11.		The fixture can be mounted after curing time. Apply installation torque $T_{inst}$ according to Table B1 or B2.

### Injection System VM-EA for concrete

**Intended use**  
Installation instructions (continuation)

**Annex B4**

**Table B3: Parameter cleaning tools**

Threaded rod	Internally threaded anchor rod	Drill bit - Ø	Brush - Ø	min. Brush - Ø
[-]	[-]	$d_0$ [mm]	$d_b$ [mm]	$d_{b,min}$ [mm]
M8	-	10	12	10,5
M10	VMU-IG M6	12	14	12,5
M12	VMU-IG M8	14	16	14,5
M16	VMU-IG M10	18	20	18,5
M20	VMU-IG M12	24	26	24,5
M24	VMU-IG M16	28	30	28,5

**Recommended compressed air tool (min 6 bar)**  
all applications



**Blow-out pump (volume 750ml)**  
Drill bit diameter ( $d_0$ ): 10 mm to 20 mm  
Drill hole depth ( $h_0$ ): ≤ 240 mm



**Cleaning brush RB**



**Table B4: Working time and curing time**

Concrete temperature	VM-EA low speed		VM-EA, VM-EA blue <sup>1)</sup>		VM-EA express	
	working time	minimum curing time	working time	minimum curing time	working time	minimum curing time
-10 to -6°C	-	-	-	-	60 min	4 h
-5 to -1°C	-	-	90 min	6 h	45 min	2 h
0 to +4°C	-	-	45 min	3 h	25 min	80 min
+5 to +9°C	-	-	25 min	2 h	10 min	45 min
+10 to +14°C	30 min	5 h	20 min	100 min	4 min	25 min
+15 to +19°C	20 min	210 min	15 min	80 min	3 min	20 min
+20 to +29°C	15 min	145 min	6 min	45 min	2 min	15 min
+30 to +34°C	10 min	80 min	4 min	25 min	-	-
+35 to +39°C	6 min	45 min	2 min	20 min	-	-
+40 to +44°C	4 min	25 min	-	-	-	-
+45 °C	2 min	20 min	-	-	-	-
<b>Cartridge temperature</b>	<b>+5°C to +45°C</b>		<b>+5°C to +40°C</b>		<b>0°C to +30°C</b>	

<sup>1)</sup> The VM-EA blue injection mortar has a curing time proof by changing the color from blue to grey after minimum curing time. The curing time proof is only valid for the standard version of the mortar

**Injection System VM-EA for concrete**

**Intended Use**  
Parameter cleaning tools, working time and curing time

**Annex B5**