

SUORITUSTASOILMOITUS

DoP Nro: **MKT-2.3-400**_fi

- ◇ **Tuotetyypin yksilöllinen tunniste:** **Ruiskutusjärjestelmä VME plus raudoitusliitännät**
- ◇ **Aiottu käyttötarkoitus (aiotut käyttötarkoitukset):** Järjestelmät myöhemmille raudoitusliitännöille, katso Liite / Annex B
- ◇ **Valmistaja:** MKT Metall-Kunststoff-Technik GmbH & Co.KG
Auf dem Immel 2
67685 Weilerbach
- ◇ **Suoritustason pysyvyyden arvioinnissa ja varmentamisessa käytetty järjestelmä/käytetyt järjestelmät:** 1
- ◇ **Eurooppalainen arviointiasiakirja:** **EAD 330087-00-0601**
Eurooppalainen tekninen arviointi: **ETA-19/0671, 10.12.2019**
Teknisestä arvioinnista vastaava laitos: DIBt, Berlin
Ilmoitettu laitos/ilmoitetut laitokset: NB 2873 – Technische Universität Darmstadt

◇ **Ilmoitettu suoritusaste/ilmoitetut suoritusastot:**

Olellaiset ominaisuudet	Suoritusaste
Mekaaninen lujuus ja vakaus (BWR 1)	
Karakteristiset vastukset staattisille ja kvasi-staattisille kuormille	Liite/Annex C1
Paloturvallisuus (BWR 2)	
Palokäyttäytyminen	Luokka A1
Palonkestävyys	Liite/Annex C2 – C3

Edellä yksilöidyn tuotteen suoritusaste on ilmoitettujen suoritusasteojen joukon mukainen. Tämä suoritusasteoilmoitus on asetuksen (EU) N:o 305/2011 mukaisesti annettu edellä ilmoitetun valmistajan yksinomaisella vastuulla.

Valmistajan puolesta allekirjoittanut:

Stefan Weustenhagen
(Toimitusjohtaja)
Weilerbach, 01.01.2021

p.p. 
Dipl.-Ing. Detlef Bigalke
(Tuotekehityksen johtaja)



Tämän suoritusasteoilmoituksen alkuperäinen teksti on kirjoitettu saksaksi. Jos käännökset poikkeavat toisistaan, saksankielinen versio on pätevä.

Specifications of intended use

Rebar	Ø8	Ø10	Ø12	Ø14	Ø16	Ø20	Ø22	Ø24	Ø25	Ø28	Ø32	Ø34	Ø36	Ø40
Static or quasi-static action								✓						
Fire exposure								✓						
Hammer drill and compressed air drill								✓						
Vacuum drill						✓								-

Tension anchor ZA	M12	M16	M20	M24
Static or quasi-static action			✓	
Fire exposure			✓	
Hammer drill and compressed air drill			✓	
Vacuum drill			✓	

Base material:

- Reinforced or unreinforced normal weight concrete acc. to EN 206: 2013+A1:2016
- Strength classes C12/15 to C50/60 acc. to EN 206:2013+A1:2016
- Maximum chloride content of 0,40 % (CL 0,40) related to the cement content acc. to EN 206:2013+A1:2016
- Non-carbonated concrete

Note: In case of a carbonated surface of the existing concrete structure the carbonated layer shall be removed in the area of the post-installed rebar connection with a diameter of $\varnothing + 60$ mm prior to the installation of the new rebar. The depth of concrete to be removed shall correspond to at least the minimum concrete cover in accordance with EN 1992-1-1:2004+AC:2010. The foregoing may be neglected if building components are new and not carbonated and if building components are in dry conditions.

Temperature range:

- - 40 °C to +80 °C (max. short term temperature +80 °C and max. long term temperature +50 °C)

Use conditions (Environmental conditions) with tension anchor ZA:

- Structures subject to dry internal conditions (zinc plated steel, stainless steel or high corrosion resistant steel)
- Structures subject to dry internal conditions or subject to external atmospheric exposure (including industrial and marine environment) and to permanently damp internal condition, if no particular aggressive conditions exist (stainless steel or high corrosion resistant steel)
- Structures subject to external atmospheric exposure and to permanently damp internal condition, if other particular aggressive conditions exist (high corrosion resistant steel)

Note: Particular aggressive conditions are e.g. permanent, alternating immersion in seawater or the splash zone of seawater, chloride atmosphere of indoor swimming pools or atmosphere with extreme chemical pollution (e.g. in desulphurization plants or road tunnels where de-icing materials are used)

Injection System VME plus for rebar connections

Intended use
Specifications of intended use

Annex B1

Specifications of intended use - continuation

Design:

- Anchorages are designed under the responsibility of an engineer experienced in anchorages and concrete work
- Verifiable calculation notes and drawings are prepared taking account of the loads to be anchored
- Anchorages are designed in accordance with EN 1992-1-1:2004+AC:2010, EN 1992-1-2:2004+AC:2008 and Annex B3 and B4
- The actual position of the reinforcement in the existing structure shall be determined on the basis of the construction documentation and taken into account when designing

Installation:

- Dry or wet concrete
- Installation in water filled bore holes is not admissible
- Hole drilling by hammer drill, compressed air drill or vacuum drill
- The installation of post-installed rebar or tension anchor ZA shall be done only by suitable trained installer and under supervision on site; the conditions under which an installer may be considered as suitable trained and the conditions for supervision on site are up to the member states in which the installation is done
- Check the position of the existing rebars (if the position of existing rebars is not known, it shall be determined using a rebar detector suitable for this purpose as well as on the basis of the construction documentation and then marked on the building component for the overlap joint)
- Minimum concrete cover acc. to EN 1992-1-1:2004+AC:2010 must be observed

Injection System VME plus for rebar connections

Intended use
Specifications of intended use - continuation

Annex B2

General construction rules for tension anchor ZA

- The length for the post-installed thread must not be added to the anchoring length
- The tension anchor ZA can only transfer forces towards the bar axis
- Tension forces must be transferred by an overlap joint into the present reinforcement of the member
- The transmission of shear forces must be ensured by additional measures, e.g. by shear cleats or anchors with an European Technical Assessment (ETA)
- In the anchor plate the holes for the tension anchors must be executed as elongated holes with axis in the direction of the shear force
- If the clear distance of overlapping bars is greater than $4\emptyset$, the lap length must be increased by a length equal to the clear space where it exceeds $4\emptyset$

Figure B1: Tension anchor ZA

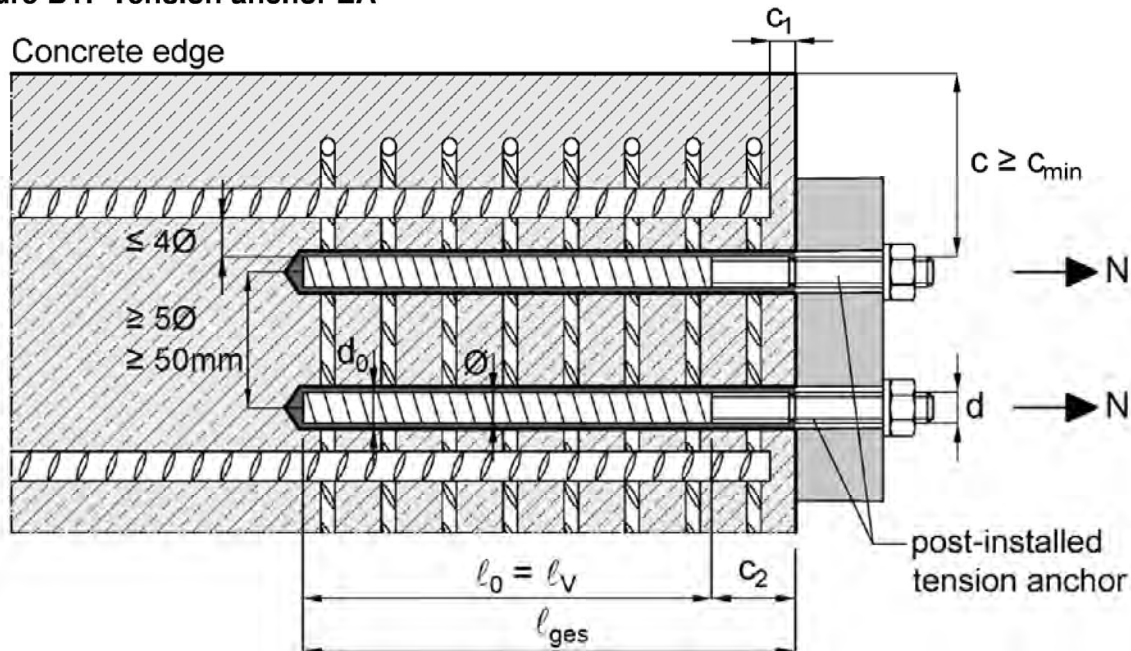

c	concrete cover of tension anchor ZA
c ₁	concrete cover at front end of cast-in-place rebar
c ₂	length of bonded thread
c _{min}	minimum concrete cover according Table B1 and EN 1992-1-1:2004+AC:2010, section 4.4.1.2
Ø	diameter of tension anchor (rebar part)
d	diameter of tension anchor (threaded part)
l ₀	lap length acc. to EN 1992-1-1:2004+AC:2010, section 8.7.3
l _v	embedment depth $l_v \geq l_0 + c_1$
l _{ges}	overall embedment depth $l_{ges} \geq l_0 + c_2$
d ₀	nominal drill bit diameter according Annex B6

Injection System VME plus for rebar connections

Intended use
General construction rules (**Tension anchor ZA**)

Annex B3

General construction rules for post-installed rebars

- The shear transfer between old and new concrete shall be designed acc. to EN 1992-1-1:2004+AC:2010
- Only tension forces in the axis of the rebar may be transmitted
- The joints for concreting must be roughened to at least such an extent that aggregate protrude
- If the clear distance of overlapping bars is greater than $4\varnothing$, the lap length must be increased by a length equal to the clear space where it exceeds $4\varnothing$

Figure B2: Post-installed rebars

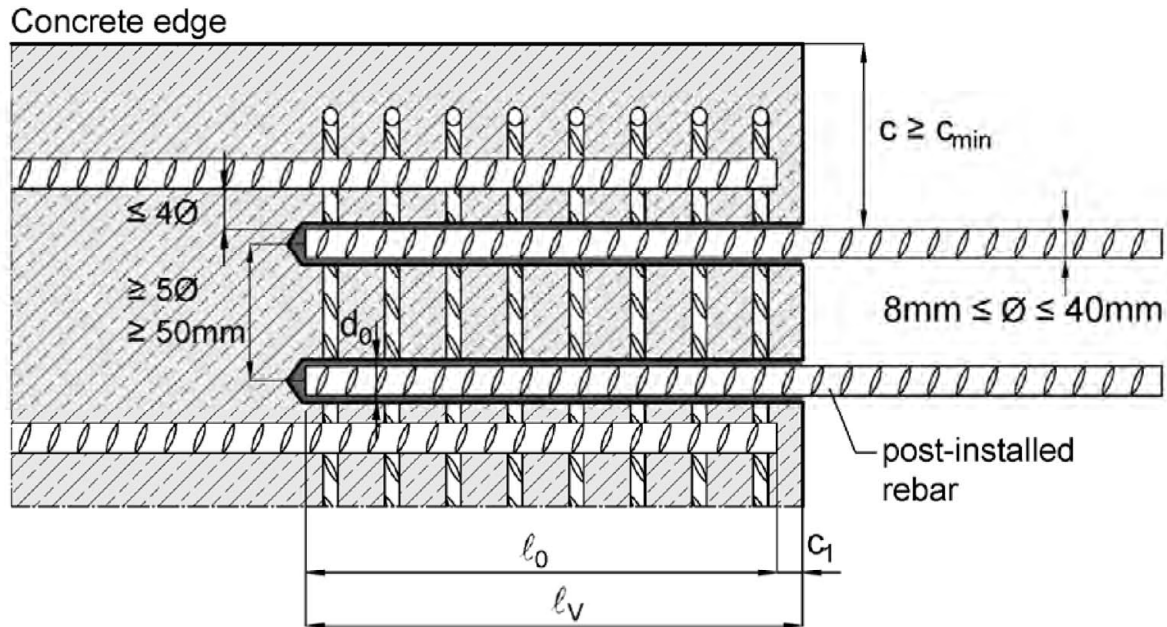

- c concrete cover of post-installed rebar
 c_1 concrete cover at front end of cast-in-place rebar
 c_{min} minimum concrete cover according Table B1 and EN 1992-1-1:2004+AC:2010, section 4.4.1.2
 \varnothing diameter of post-installed rebar
 l_0 lap length acc. to EN 1992-1-1:2004+AC:2010, section 8.7.3
 l_v embedment depth $l_v \geq l_0 + c_1$
 d_0 nominal drill bit diameter according to Annex B6

Injection System VME plus for rebar connections

Intended use
 General construction rules (**post-installed rebar**)

Annex B4

Table B1: Minimum concrete cover $c_{min}^{1)}$ of post-installed rebar and tension anchor ZA depending on drill method

Drilling method	Rod diameter	c_{min}	
		without drilling aid	with drilling aid
Hammer drilling Vacuum drilling	< 25 mm	30 mm + 0,06 $l_v \geq 2 \varnothing$	30 mm + 0,02 $l_v \geq 2 \varnothing$
	≥ 25 mm	40 mm + 0,06 $l_v \geq 2 \varnothing$	40 mm + 0,02 $l_v \geq 2 \varnothing$
Compressed air drilling	< 25 mm	50 mm + 0,08 l_v	50 mm + 0,02 l_v
	≥ 25 mm	60 mm + 0,08 l_v	60 mm + 0,02 l_v

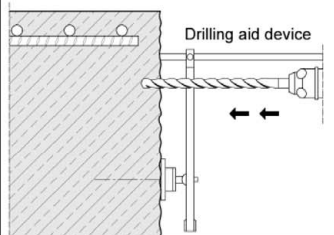

¹⁾ See Annex B3 and B4; Minimum concrete cover acc. to EN 1992-1-1:2004+AC:2010 must be observed

Table B2: Dimensions and installation parameters of tension anchor ZA

Anchor size			M12	M16	M20	M24
Thread diameter	d	[mm]	12	16	20	24
Rebar diameter	\varnothing	[mm]	12	16	20	25
Nominal drill hole diameter	d_0	[mm]	16	20	25	32
Diameter of clearance hole in fixture	d_f	[mm]	14	18	22	26
Width across nut flats	SW	[mm]	19	24	30	36
Cross section area (threaded part)	A_s	[mm ²]	84	157	245	353
Effective embedment depth	l_v	[mm]	according to static calculation			
Length of bonded thread	steel, zinc plated	c_2	[mm]	≥ 20		
	A4/HCR			≥ 100		
Maximum installation torque	T_{inst}	[Nm]	50	100	150	150

Table B3: Working and curing time

Bore hole temperature	Working time ¹⁾	Minimum curing time	
		dry concrete	wet concrete
[-]	[t_{gel}]	[$t_{cure,dry}$]	[$t_{cure,wet}$]
+5°C to +9°C	80 min	48 h	96 h
+ 10°C to + 14°C	60 min	28 h	56 h
+ 15°C to + 19°C	40 min	18 h	36 h
+ 20°C to + 24°C	30 min	12 h	24 h
+ 25°C to + 34°C	12 min	9 h	18 h
+ 35°C to + 39°C	8 min	6 h	12 h
+40 °C	8 min	4 h	8 h
Cartridge temperature	+5°C to +40°C		

¹⁾ t_{gel} : maximum time from starting of mortar injection to completing of rebar setting

Injection System VME plus for rebar connections

Intended use

Minimum concrete cover / Installation parameters ZA / Working and curing time

Annex B5

Table B4: Installation tools and max. embedment depth – Hammer drilling (HD) or compressed air drilling (CD)

Rebar size Ø	Tension anchor ZA	Drill bit diameter d ₀		Brush- Ø d _b		Brush- Ø d _{b,min}	Retaining washer ¹⁾	Cartridge 440ml or 585ml		Cartridge 1400 ml	Extension pipe
		HD	CD	Hand- or akku-tool	Compressed air tool			Compressed air tool			
								l _{v,max}	l _{v,max}	l _{v,max}	
[mm]	[-]	[mm]	[mm]	[-]	[mm]	[mm]	[-]	[cm]	[cm]	[cm]	[-]
8	-	10	-	RB10	11,5	10,5	-	25	25	25	VM-XE 10 (l _{v,max} ≤ 130mm) or VM-XLE 16
	-	12	-	RB12	13,5	12,5	-	70	80	80	
10	-	12	-	RB12	13,5	12,5	-	25	25	25	
	-	14	-	RB14	15,5	14,5	VM-IA 14	70	100	100	
12	M12	14	-	RB14	15,5	14,5	VM-IA 14	25	25	25	
		16	16	RB16	17,5	16,5	VM-IA 16	70	130	120	
14	-	18	18	RB18	20,0	18,5	VM-IA 18	70	130	140	
16	M16	20	20	RB20	22,0	20,5	VM-IA 20	70	130	160	
20	M20	25	-	RB25	27,0	25,5	VM-IA 25	50	100	200	
		-	26	RB26	28,0	26,5	VM-IA 25	50	100	200	
22	-	28	28	RB28	30,0	28,5	VM-IA 28	50	100	200	
24	-	32	32	RB32	34,0	32,5	VM-IA 32	50	100	200	
25	M24	32	32	RB32	34,0	32,5	VM-IA 32	50	100	200	
28	-	35	35	RB35	37,0	35,5	VM-IA 35	50	100	200	
32	-	40	40	RB40	43,5	40,5	VM-IA 40	50	100	200	
34	-	40	40	RB40	43,5	40,5	VM-IA 40	-	100	200	
36	-	45	45	RB45	47,0	45,5	VM-IA 45	-	100	200	
40	-	55	55	RB55	58,0	55,5	VM-IA 55	-	100	200	

¹⁾ For horizontal or overhead installation and bore holes deeper than 240mm

Table B5: Installation tools and max. embedment depth – vacuum drilling (VD)

Rebar size Ø	Tension anchor ZA	Drill bit diameter d ₀		Brush- Ø d _b		Brush- Ø d _{b,min}	Retaining washer ¹⁾	Cartridge 440ml or 585ml		Cartridge 1400 ml	Extension pipe
		VD	Hand- or akku-tool	Compressed air tool	Compressed air tool						
					l _{v,max}			l _{v,max}	l _{v,max}		
[mm]	[-]	[mm]	[-]	[mm]	[mm]	[mm]	[-]	[cm]	[cm]	[cm]	[-]
8	-	10	No cleaning required				-	25	25	25	VM-XE 10 or VM-XLE 16
	-	12					-	70	80	80	
10	-	12					-	25	25	25	
	-	14					VM-IA 14	70	100	100	
12	M12	14					VM-IA 14	25	25	25	
		16					VM-IA 16	70	100	100	
14	-	18					VM-IA 18	70	100	100	
16	M16	20					VM-IA 20	70	100	100	
20	M20	25					VM-IA 25	50	100	100	
22	-	28					VM-IA 28	50	100	100	
24	-	32					VM-IA 32	50	100	100	
25	M24	32					VM-IA 32	50	100	100	
28	-	35					VM-IA 35	50	100	100	
32	-	40					VM-IA 40	50	100	100	

¹⁾ For horizontal or overhead installation and bore holes deeper than 240mm

Injection System VME plus for rebar connections

Intended use

Installation tools and max. embedment depth – all drilling methods

Annex B6

Cleaning and installation tools

Vacuum drill bit



Vacuum drill bit (MKT Hollow drill bit SB, Würth Hammer drill bit with suction or Heller Duster Expert hollow drill bit system) and a vacuum cleaner with minimum negative pressure of 253 hPa and flow rate of min. 150m³/h (42 l/s)

Compressed air hose (min. 6 bar) with air valve



Recommended compressed air tool (min. 6 bar)



Brush RB



Brush extension



SDS Plus Adapter

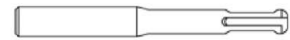

Table B6: Dispensing tools

Cartridge		Hand tool	Pneumatic tool
Type	Size		
side-by-side	440 ml, 585 ml	e.g.: VM-P 585 Profi or VM-P 585 Akku	e.g.: VM-P 585 Pneumatik
	1400 ml	-	e.g.: VM-P 1400 Pneumatik

Injection System VME plus for rebar connections

Intended use
Cleaning and installation tools / Dispensing tools

Annex B7

Installation instructions

Bore hole drilling

Attention: Before drilling, remove carbonated concrete and clean contact surface (see Annex B1). In case of aborted holes, the bore holes must be filled with mortar.

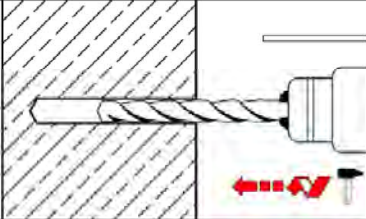
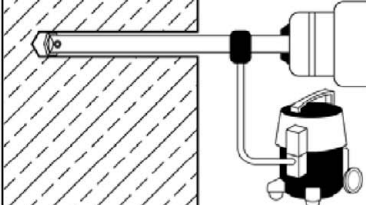
1	1a		<p>Hammer drilling or compressed air drilling Drill hole with drill bit diameter according to Table B4 and selected embedment depth. Proceed with step 2.</p>
	1b		<p>Vacuum drilling Drill hole with drill bit diameter according to Table B5 and selected embedment depth. This drilling method removes dust and cleans the bore hole during drilling. Proceed with step 3.</p>

Cleaning for hammer or compressed air drilled holes

Attention: remove standing water before cleaning

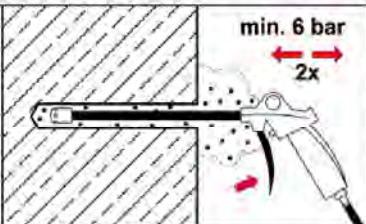
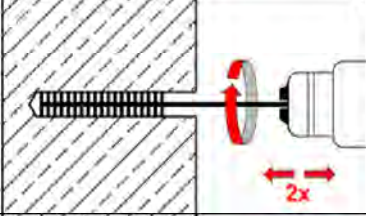
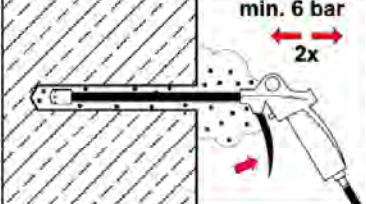
2	2a		<p>Starting from the bottom or back of the bore hole, blow out the hole with compressed air (min. 6 bar) (Annex B7) a minimum of two times until return air stream is free of noticeable dust. If bore hole ground is not reached, an extension must be used.</p>
	2b		<p>Brush the hole with an appropriate sized wire brush $\geq d_{b,min}$ (Table B4, check minimum brush diameter $d_{b,min}$) a minimum of two times using a drilling machine or battery screw driver. If bore hole ground is not reached, a brush extension must be used.</p>
	2c		<p>Finally blow the hole clean again with compressed air (min. 6 bar) (Annex B7) a minimum of two times until return air stream is free of noticeable dust. If bore hole ground is not reached, an extension must be used</p>

After cleaning, the drill hole has to be protected against re-contamination in an appropriate way, until dispensing the mortar in the drill hole. If necessary, the cleaning has to be repeated directly before dispensing the mortar. In-flowing water must not contaminate the drill hole again.

Injection System VME plus for rebar connections

Intended use

Installation instruction
Bore hole drilling and cleaning

Annex B8

Installation instruction (continuation)

Preparing the borehole

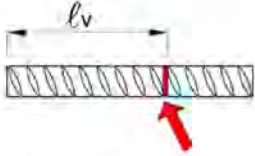
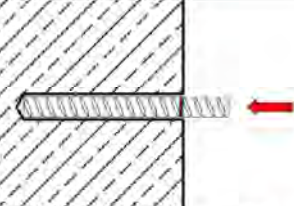
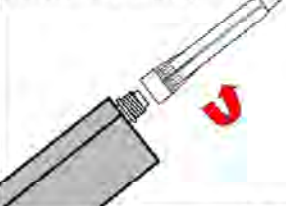
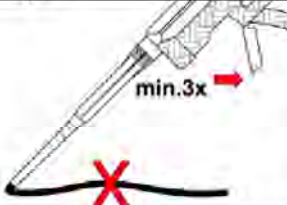
3		Mark the position of the embedment depth l_v (e.g. with tape).
4		Check drill hole depth by inserting rebar or anchor rod into the empty hole. The anchor should be free of dirt, grease, oil or foreign material.
5		Prepare cartridge with static mixer (if necessary with extension pipe and retaining washer). Attach the supplied static mixer to the cartridge and load the cartridge into the correct dispensing tool (Table B6). For every working interruption longer than the recommended working time (Table B3) as well as for new cartridges, a new static-mixer shall be used.
6		Prior to applying, discard mortar (forerun) until the mortar shows a consistent grey or red colour, but at least three full strokes and discard non-uniformly mixed adhesive components.

Making of extension pipe:

(all drilling methods)

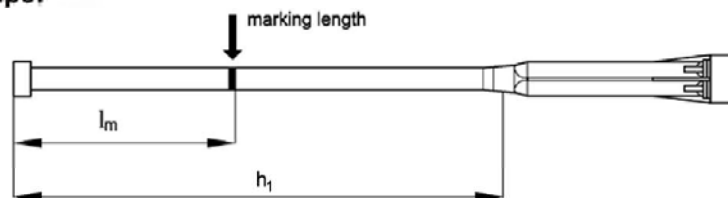

On the static mixer and the extension pipe the mortar filling mark l_m and the drill hole depth h_1 must be marked with an adhesive tape or text marker. Rough estimate: $l_m = \frac{1}{3} \cdot h_1$

Fill in the mortar as long until the filling mark l_m will be visible.

Optimal mortar volume: $l_m = h_1 * (1,2 * \frac{\phi^2}{d_0^2} - 0,2)$ [mm]

l_m length from the end of the retaining washer to the mark on the mixer extension

h_1 drill hole depth = embedment depth (l_v resp. l_{ges})

ϕ rebar diameter

d_0 nominal drill bit diameter

Injection System VME plus for rebar connections

Intended use

Installation instruction (continuation) - Preparing the borehole
Marking of extension pipe



Annex B9

Installation instruction (continuation)

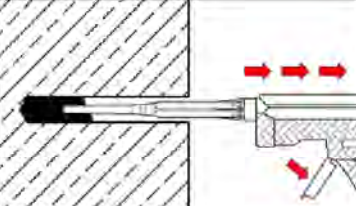
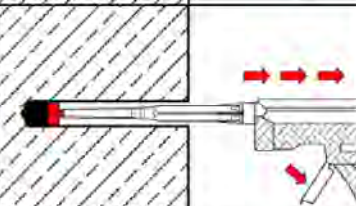
Injection into borehole

7		<p>Start from the bottom or the back of the cleaned bore hole, fill with adhesive until the level mark at the mixer extension (Annex B9) is visible at the top of the hole. Slowly withdraw the static mixing nozzle and using a piston plug during injection of the mortar, helps to avoid air pockets. For embedment larger than 190 mm an extension nozzle shall be used (Annex B6). Observe temperature dependent working times given in Table B3.</p>
8		<p>For horizontal or overhead installations and bore holes deeper than 240 mm, retaining washer (and appropriate mixer extension) must be used. Observe temperature dependent working times given in Table B3.</p>

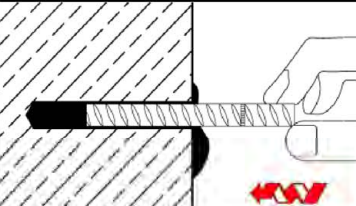
Installation of rebar or tension anchor

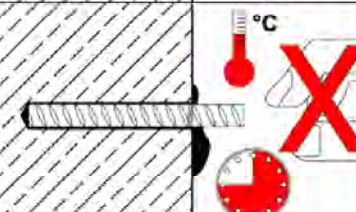
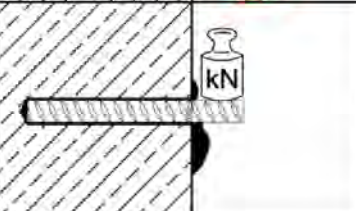
9		<p>Push the reinforcing bar or tension anchor into the bore hole while turning slightly to ensure positive distribution of the adhesive until the embedment depth is reached.</p>
10		<p>Be sure that the rebar or tension anchor is inserted in the bore hole until the embedment mark is at the concrete surface and excess mortar is visible at the top of the hole. If these requirements are not maintained, repeat application before end of working time! For overhead installation, the anchor should be fixed (e.g. by wedges).</p>
11		<p>Observe working and curing time according Table B3. Attention: the curing and working time can vary according to the base material temperature (Table B3).</p> <p>Do not move or load until full curing time t_{cure} has elapsed.</p>
12		<p>After the curing time the reinforcing bar or tension anchor can be loaded.</p>

Injection System VME plus for rebar connections

Intended use

Installation instruction (continuation)
Injection into borehole – Installation of rebar or tension anchor

Annex B10

Minimum anchorage length and minimum lap length

The minimum anchorage length $\ell_{b,min}$ and the minimum lap length $\ell_{0,min}$ according to EN 1992-1-1:2004+AC:2010 ($\ell_{b,min}$ acc. to Eq. 8.6 and Eq. 8.7 and $\ell_{0,min}$ acc. to Eq. 8.11) shall be multiplied by the amplification factor α_{lb} acc. to Table C1.

Table C1: Amplification factor α_{lb} – all drilling methods

Amplification factor	Rod diameter	Concrete strength class								
		C12/15	C16/20	C20/25	C25/30	C30/37	C35/45	C40/50	C45/55	C50/60
α_{lb} [-]	Ø8 to Ø40 ZA-M12 to ZA-M24	1,0								

Table C2: Reduction factor k_b for all drilling methods

Reduction-factor	Rod diameter	Concrete strength class								
		C12/15	C16/20	C20/25	C25/30	C30/37	C35/45	C40/50	C45/55	C50/60
k_b [-]	Ø8 to Ø40 ZA-M12 to ZA-M24	1,0								

Table C3: Design values of the ultimate bond stress $f_{bd,PIR}$ in N/mm² for all drilling methods and for good bond conditions

$$f_{bd,PIR} = k_b \cdot f_{bd}$$

with

f_{bd} : Design value of the ultimate bond stress in N/mm² considering the concrete strength classes and the rebar diameter according to EN 1992-1-1:2004+AC:2010

(for all other bond conditions multiply the values by 0,7)

k_b : Reduction factor according to Table C2

Bond strength	Rod diameter	Concrete strength class								
		C12/15	C16/20	C20/25	C25/30	C30/37	C35/45	C40/50	C45/55	C50/60
$f_{bd,PIR}$ [N/mm ²]	Ø8 to Ø32 ZA-M12 to ZA-M24	1,6	2,0	2,3	2,7	3,0	3,4	3,7	4,0	4,3
	Ø34	1,6	2,0	2,3	2,6	2,9	3,3	3,6	3,9	4,2
	Ø36	1,5	1,9	2,2	2,6	2,9	3,3	3,6	3,8	4,1
	Ø40	1,5	1,8	2,1	2,5	2,8	3,1	3,4	3,7	4,0

Injection System VME plus for rebar connections

Performances

Amplification factor α_{lb} / Reduction factor k_b / Design values of ultimate bond resistance $f_{bd,PIR}$

Annex C1

Design value of ultimate bond stress $f_{bd,fi}$ under fire exposure for concrete classes C12/15 to C50/60 (all drilling methods):

The design value of ultimate bond stress $f_{bd,fi}$ under fire exposure will be calculated by the following equation:

$$f_{bd,fi} = k_{fi}(\theta) \cdot f_{bd,PIR} \cdot \gamma_c / \gamma_{M,fi}$$

mit: $\theta \leq 278^\circ\text{C}$: $k_{fi}(\theta) = 4373,8 \cdot \theta^{-1,598} / (f_{bd,PIR} \cdot 4,3) \leq 1,0$

$\theta > 278^\circ\text{C}$: $k_{fi}(\theta) = 0$

$f_{bd,fi}$ design value of ultimate bond stress in case of fire in N/mm²

θ Temperature in °C in the mortar layer

$k_{fi}(\theta)$ Reduction factor under fire exposure

$f_{bd,PIR}$ Design value of the ultimate bond stress in N/mm² in cold condition according to Table C3 considering concrete class, rebar diameter, drilling method and the bond conditions according to EN 1992-1-1:2004+AC:2010

γ_c partial factor acc. to EN 1992-1-1:2004+AC:2010

$\gamma_{M,fi}$ partial factor acc. to EN 1992-1-2:2004+AC:2008

For evidence under fire exposure the anchorage length shall be calculated acc. to EN 1992-1-1:2004+AC:2010 Equation 8.3 using the temperature-dependent ultimate bond stress $f_{bd,fi}$.

Figure C1: Example graph of reduction factor $k_{fi}(\theta)$
Concrete strength class C20/25 for good bond conditions

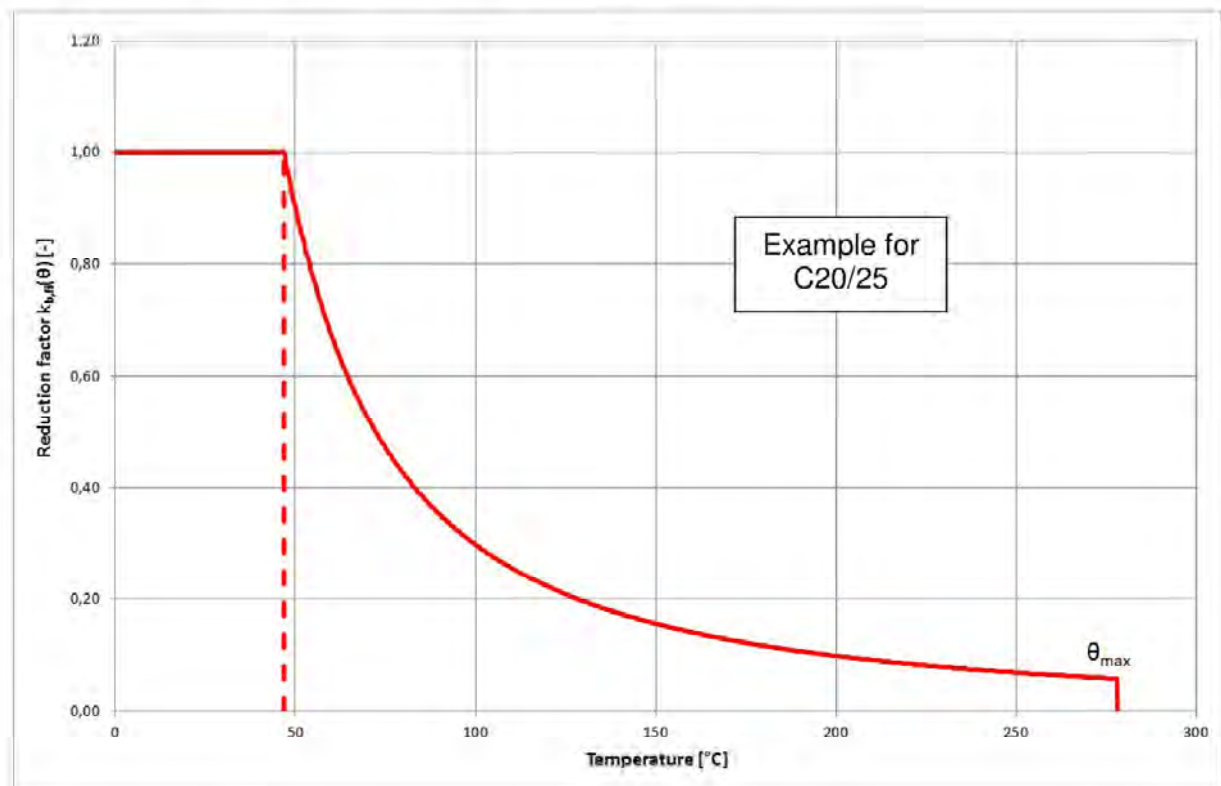

Injection System VME plus for rebar connections

Performances

Design value of ultimate bond stress $f_{bd,fi}$ under fire exposure for rebar

Annex C2

Table C4: Characteristic tension strength in case of fire for tension anchor ZA, concrete strength class C12/15 to C50/60, acc. to Technical Report TR 020

Tension anchor ZA		M12	M16	M20	M24
Steel failure					
Steel, zinc plated					
Characteristic tension strength	R30	$\sigma_{Rk,s,fi}$ [N/mm ²]	20		
	R60		15		
	R90		13		
	R120		10		
Stainless steel A4, HCR					
Characteristic tension strength	R30	$\sigma_{Rk,s,fi}$ [N/mm ²]	30		
	R60		25		
	R90		20		
	R120		16		

Design value of the tension strength $\sigma_{Rd,s,fi}$ under fire exposure for tension anchor ZA

The design value of the steel strength $\sigma_{Rd,s,fi}$ under fire exposure will be calculated by the following equation:

$$\sigma_{Rd,s,fi} = \sigma_{Rk,s,fi} / \gamma_{M,fi}$$

with:

- $\sigma_{Rk,s,fi}$ characteristic steel strength acc. to Table C4
- $\gamma_{M,fi}$ partial factor under fire exposure acc. to EN 1992-1-2:2004+AC:2008

Injection System VME plus for rebar connections	Annex C3
Performances Steel strength for tension anchor ZA under fire exposure	