



... eine starke Verbindung

## PRESTATIEVERKLARING

DoP Nr.: **MKT-540** - nl

- ◇ **Unieke identificatiecode van het producttype:** **Injectiesysteem VMH achteraf wapeningsaansluiting**
- ◇ **Beoogd(e) gebruik(en):** **Systeem achteraf wapeningsaansluiting ,  
zie bijlage / Annex B**
- ◇ **Fabrikant:** **MKT Metall-Kunststoff-Technik GmbH & Co.KG  
Auf dem Immel 2  
67685 Weilerbach**
- ◇ **Het systeem of de systemen voor de  
Beoordeling en verificatie van de  
prestatiebestendigheid:** **1**
- ◇ **Europees beoordelingsdocument:** **EAD 330087-00-0601**  
Europese technische beoordeling: **ETA-17/0715, 18.07.2018**  
Technische beoordelingsinstantie: **DIBt, Berlin**  
Aangemelde instantie(s): **NB 1343 – MPA, Darmstadt**

◇ **Aangegeven prestatie(s):**

Essentiële kenmerken	Prestaties
<b>Mechanische weerstand en stabiliteit (BWR1)</b>	
Karakteristieke weerstanden voor statische en quasi-statische belastingen	Bijlage/Annex C1
<b>Brandveiligheid (BWR2)</b>	
Brandgedrag	Klasse A1
Brandwerendheid	Bijlage/Annex C2 – C3

De prestaties van het hierboven omschreven product zijn conform de aangegeven prestaties. Deze prestatieverklaring wordt in overeenstemming met Verordening (EU) nr. 305/2011 onder de exclusieve verantwoordelijkheid van de hierboven vermelde fabrikant verstrekt.

Ondertekend voor en namens de fabrikant door:

  
**Stefan Weustenhagen**  
 (Directeur)  
**Weilerbach, 18.07.2018**

p.p.   
**Dipl.-Ing. Detlef Bigalke**  
 (Hoofd productontwikkeling)



Het origineel van deze prestatieverklaring was in het Duits geschreven. In geval van afwijkingen in de vertaling is de Duitse versie geldig.

## Specifications of intended use

### Anchorage subject to:

Rebar	Ø8	Ø10	Ø12	Ø14	Ø16	Ø20	Ø22	Ø24	Ø25	Ø28	Ø32
Static or quasi static action											✓
Fire exposure											✓

Tension anchor ZA	M12	M16	M20	M24
Static or quasi static action			✓	
Fire exposure			✓	

### Base material:

- Reinforced or unreinforced normal weight concrete acc. to EN 206-1:2000
- Strength classes C12/15 to C50/60 acc. to EN 206-1:2000
- Maximum chloride concrete of 0,40 % (CL 0,40) related to the cement content acc. to EN 206-1:2000
- Non-carbonated concrete

Note: In case of a carbonated surface of the existing concrete structure the carbonated layer shall be removed in the area of the post-installed rebar connection with a diameter of  $\varnothing + 60$  mm prior to the installation of the new rebar. The depth of concrete to be removed shall correspond to at least the minimum concrete cover in accordance with EN 1992-1-1:2004+AC:2010.

The foregoing may be neglected if building components are new and not carbonated and if building components are in dry conditions.

### Temperature range:

- - 40 °C to +80 °C (max. short term temperature +80 °C and max. long term temperature +50 °C)

### Use conditions (Environmental conditions):

- Structures subject to dry internal conditions (zinc plated steel, stainless steel or high corrosion resistant steel)
- Structures subject to external atmospheric exposure (including industrial and marine environment) and to permanently damp internal condition, if no particular aggressive conditions exist (stainless steel or high corrosion resistant steel)
- Structures subject to external atmospheric exposure and to permanently damp internal condition, if other particular aggressive conditions exist (high corrosion resistant steel)

Note: Particular aggressive conditions are e.g. permanent, alternating immersion in seawater or the splash zone of seawater, chloride atmosphere of indoor swimming pools or atmosphere with extreme chemical pollution (e.g. in desulphurization plants or road tunnels where de-icing materials are used)

**Injection System VHM** for rebar connections

**Intended use**  
Specifications of intended use

**Annex B1**

## Specifications of intended use

### Design:

- Verifiable calculation notes and drawings are prepared taking account of the loads to be anchored
- Anchorages are designed under the responsibility of an engineer experienced in anchorages and concrete work
- Anchorages are designed in accordance with EN 1992-1-1:2004+AC:2010, EN1992-1-2:2004+AC:2008 and Annex B3 and B4
- The actual position of the reinforcement in the existing structure shall be determined on the basis of the construction documentation and taken into account when designing

### Installation:

- Dry or wet concrete
- Installation in water filled bore holes is not admissible
- Overhead installation admissible
- Hole drilling by hammer drill, vacuum drill or compressed air drill
- Check the position of the existing rebars (if the position of existing rebars is not known, it shall be determined using a rebar detector suitable for this purpose as well as on the basis of the construction documentation and then marked on the building component for the overlap joint)
- The joints for concreting must be roughened to at least such an extent that aggregate protrude
- The installation of post-installed rebar or tension anchor ZA shall be done only by suitable trained installer and under supervision on site; the conditions under which an installer may be considered as suitable trained and the conditions for supervision on site are up to the member states in which the installation is done
- Minimum concrete cover acc. to EN 1992-1-1:2004+AC:2010 must be observed

**Injection System VHM** for rebar connections

**Intended use**  
Specifications of intended use

**Annex B2**

## General construction rules for tension anchor ZA

- The length for the post-installed thread must not be added to the anchoring length
- The tension anchor ZA can only transfer forces towards the bar axis
- Tension forces must be transferred by an overlap joint into the present reinforcement of the member
- The transmission of shear forces must be ensured by additional measures, e.g. by shear cleats or anchors with an European Technical Assessment (ETA)
- In the anchor plate the holes for the tension anchors must be executed as elongated holes with axis in the direction of the shear force
- If the clear distance of overlapping bars is greater than  $4\varnothing$ , the lap length must be increased by a length equal to the clear space where it exceeds  $4\varnothing$

Figure B1: Tension Anchor ZA

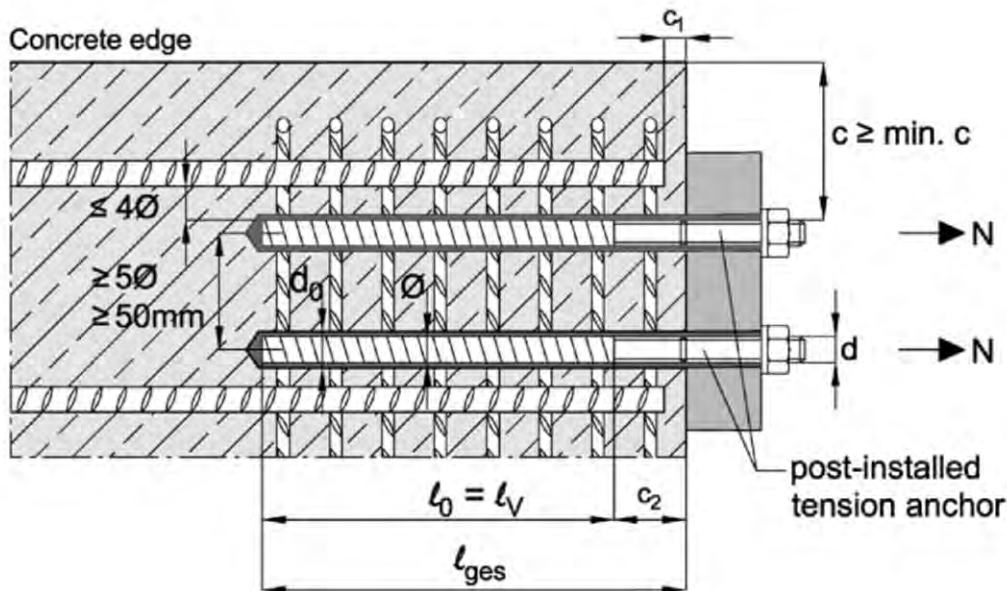

c	concrete cover of tension anchor ZA
c <sub>1</sub>	concrete cover at front end of cast-in-place rebar
c <sub>2</sub>	Length of bonded thread
min c	minimum concrete cover according to Table B1 and EN 1992-1-1:2004+AC:2010
Ø	diameter of tension anchor (rebar part)
d	diameter of tension anchor (threaded part)
l <sub>0</sub>	lap length acc. to EN 1992-1-1:2004+AC:2010
l <sub>v</sub>	embedment depth $l_v \geq l_0 + c_1$
l <sub>ges</sub>	overall embedment depth $l_{ges} \geq l_0 + c_2$
d <sub>0</sub>	nominal drill bit diameter according to Annex B6, to Table B4

Injection System VHM for rebar connections

Intended use  
General construction rules (Tension anchor ZA)

Annex B3

## General construction rules for post-installed rebars

- The shear transfer between old and new concrete shall be designed acc. to EN 1992-1-1:2004+AC:2010
- Only tension forces in the axis of the rebar may be transmitted
- If the clear distance of overlapping bars is greater than  $4\emptyset$ , the lap length must be increased by a length equal to the clear space where it exceeds  $4\emptyset$

Figure B2: Post-installed rebars

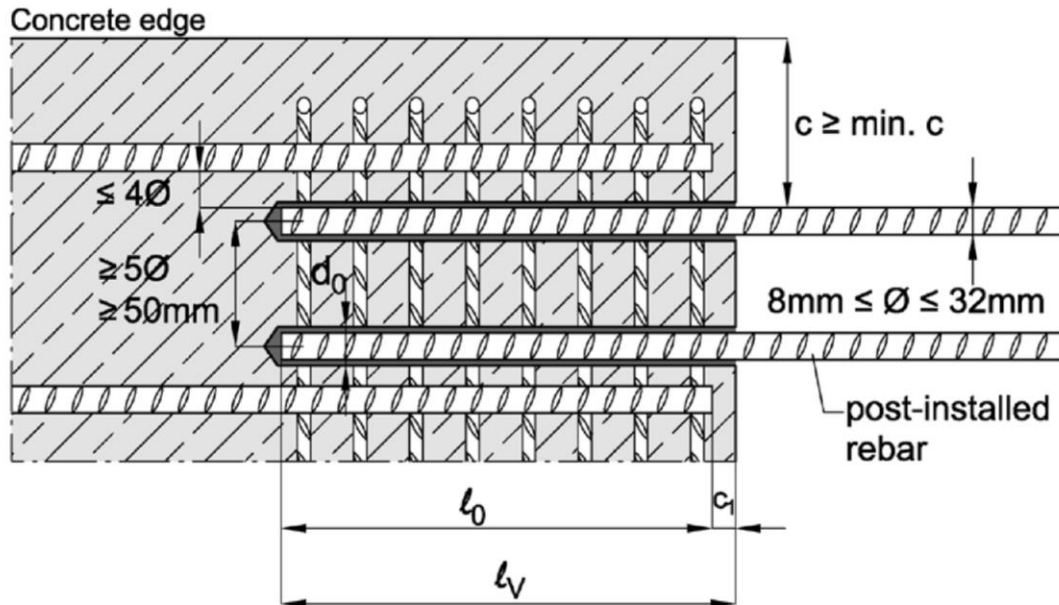

- $c$  concrete cover of post-installed rebar  
 $c_1$  concrete cover at front end of cast-in-place rebar  
 $\min c$  minimum concrete cover according Table B1 and EN 1992-1-1:2004+AC:2010  
 $\emptyset$  diameter of tension anchor (rebar)  
 $l_0$  lap length acc. to EN 1992-1-1:2004+AC:2010  
 $l_v$  embedment depth  $l_v \geq l_0 + c_1$   
 $d_0$  nominal drill bit diameter according to Annex B6, Table B4

Injection System VHM for rebar connections

Intended use  
General construction rules (**post-installed rebar**)

Annex B4

**Table B1: Minimum concrete cover min c<sup>1)</sup> of post-installed rebar and tension anchor ZA depending on drilling method**



Drilling method	Rod diameter	min c	
		(without drilling aid device)	(with drilling aid device)
Hammer drilling Vacuum drilling	< 25 mm	30 mm + 0,06 $l_v \geq 2 \varnothing$	30 mm + 0,02 $l_v \geq 2 \varnothing$
	$\geq 25$ mm	40 mm + 0,06 $l_v \geq 2 \varnothing$	40 mm + 0,02 $l_v \geq 2 \varnothing$
Compressed air drilling	< 25 mm	50 mm + 0,08 $l_v$	50 mm + 0,02 $l_v$
	$\geq 25$ mm	60 mm + 0,08 $l_v$	60 mm + 0,02 $l_v$

<sup>1)</sup> See Annex B3 and B4; Minimum concrete cover acc. to EN 1992-1-1:2004+AC:2010 must be observed

**Table B2: Dimensions and installation parameters of tension anchor ZA**

Anchor size			M12	M16	M20	M24	
Thread diameter	d	[mm]	12	16	20	24	
Rebar diameter	$\varnothing$	[mm]	12	16	20	25	
Cross section area (threaded part)	A <sub>s</sub>	[mm <sup>2</sup> ]	84	157	245	353	
Width across nut flats	SW	[mm]	19	24	30	36	
Effective embedment depth	$l_v$	[mm]	according to static calculation				
Length of bonded thread	steel, zinc plated	c <sub>2</sub>	[mm]	$\geq 20$	$\geq 20$	$\geq 20$	$\geq 20$
	A4/HCR			$\geq 100$	$\geq 100$	$\geq 100$	$\geq 100$
Maximum installation torque	T <sub>inst</sub>	[Nm]	50	100	150	150	

**Table B3: Working and curing time**

Bore hole temperature	Working time	Minimum curing time	
		dry concrete	wet concrete
- 5 °C to - 1 °C	50 min	5 h	10 h
0 °C to + 4 °C	25 min	3,5 h	7 h
+ 5 °C to + 9 °C	15 min	2 h	4 h
+ 10 °C to + 14 °C	10 min	1 h	2 h
+ 15 °C to + 19 °C	6 min	40 min	80 min
+ 20 °C to + 29 °C	3 min	30 min	60 min
+ 30 °C to + 40 °C	2 min	30 min	60 min
Cartridge temperature	+5°C to +40°C		

**Injection System VHM** for rebar connections

**Intended use**

Minimum concrete cover / Installation parameters ZA / Working and curing time

**Annex B5**

**Table B4: Drilling and cleaning**

Rebar Ø	Tension anchor ZA	Drill bit diameter $d_0$	Brush diameter	
			Brush- Ø	min. Brush- Ø
			$d_b$	$d_{b,min}$
[mm]	[-]	[mm]	[mm]	[mm]
8		12	14	12,5
10		14	16	14,5
12	M12	16	18	16,5
14		18	20	18,5
16	M16	20	22	20,5
20	M20	25	27	25,5
22		28	30	28,5
24		32	34	32,5
25	M24	32	34	32,5
28		35	37	35,5
32		40	43	40,5

**Compressed air hose  
(min. 6 bar) with air valve**



**Recommended compressed air tool  
(min. 6 bar)**



**Brush RB**



**Brush extension**



**SDS Plus Adapter**



**Retaining washer  
VM-IA**



**Extension pipe**



**Static mixer**



**Injection System VHM for rebar connections**

**Intended use**  
Cleaning and installation tools

**Annex B6**

**Table B5: Installation tools and max. embedment depth**

Rebar Ø	Tension anchor ZA	Drill bit diameter d <sub>0</sub>	Retaining washer <sup>1)</sup>	Cartridges: all formats				Cartridge: side-by-side (825 ml)		
				Hand- or akku-tool		Compressed air tool		Compressed air tool		
				l <sub>v,max</sub> [cm]	Extension pipe	l <sub>v,max</sub> [cm]	Extension pipe	l <sub>v,max</sub> [cm]	Extension pipe	
8		12	-	70	VM-XE 10	80	VM-XE 10	80	VM-XE 10	
10		14	VM-IA 14			100		100		100
12	M12	16	VM-IA 16					120		120
14		18	VM-IA 18			140		140		
16	M16	20	VM-IA 20	50	VM-XE 10 VM-XLE 16	70	VM-XE 10 VM-XLE 16	160	VM-XLE 16	
20	M20	25	VM-IA 25			200		200		
22		28	VM-IA 28					50		200
24		32	VM-IA 32			200				200
25	M24	32	VM-IA 32							200
28		35	VM-IA 35			200				
32		40	VM-IA 40							

<sup>1)</sup> For horizontal or overhead installation as well as for drill holes deeper than 240mm

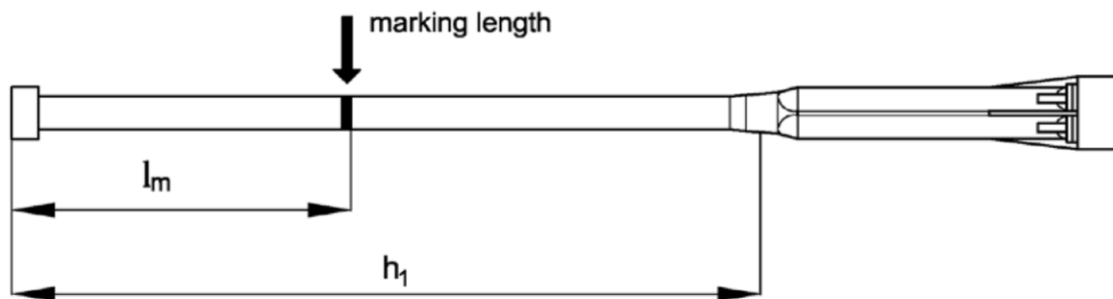

On the static mixer and the extension pipe the mortar filling mark  $l_m$  and the drill hole depth  $h_1$  must be marked with an adhesive tape or text marker. Rough estimate:  $l_m = \frac{1}{3} \cdot h_1$

Fill in the mortar as long until the filling mark  $l_m$  will be visible.

Optimal mortar volume:  $l_m = h_1 * (1,2 * \frac{\phi^2}{d_0^2} - 0,2)$  [mm]

- $l_m$  Length from the end of the retaining washer to the mark on the mixer extension
- $h_1$  drill hole depth = embedment depth  $l_v$  resp.  $l_{ges}$ )
- Ø rebar diameter
- $d_0$  nominal drill bit diameter

**Injection System VHM** for rebar connections

**Intended use**

Installation tools, max. embedment depth, marking of extension pipe

**Annex B7**



**Table B6: Dispensing tools**

Cartridge		Hand tool		Pneumatic tool
Type	Size			
coaxial	150, 280, 333 ml	e.g.: VM-P 330		e.g.: VM-P 345 Pneumatic
	380 to 420 ml	e.g.: VM-P 380 Standard	e.g.: VM-P 380 Profi	e.g.: VM-P 380 Pneumatic
side-by-side	235, 345 ml	e.g.: VM-P 345 Standard	e.g.: VM-P 345 Profi	e.g.: VM-P 345 Pneumatic
	825 ml	-	-	e.g.: VM-P 825 Pneumatic

All cartridges can also be extruded by battery tool (e.g. VM-P Akku)

**Injection System VHM** for rebar connections

**Intended use**  
Dispensing tools

**Annex B8**

## Installation instructions

### Bore hole drilling

1.



Drill hole by hammer drilling, vacuum drilling or compressed air drilling (with drill bit diameter according to Annex B7 and selected embedment depth). In case of aborted holes, the bore holes must be filled with mortar.

### Cleaning

2a.

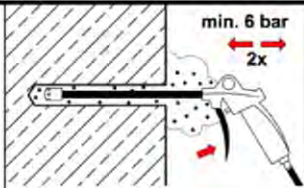

Starting from the bottom or back of the bore hole, blow out the hole with compressed air (min. 6 bar) (Annex B6) a minimum of **two** times until return air stream is free of noticeable dust. If the bore hole ground is not reached, an extension must be used.

2.

2b.

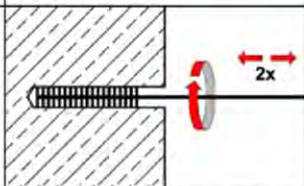

Brush the hole with an appropriate sized wire brush  $\geq d_{b,min}$  (Table B4, check minimum brush diameter  $d_{b,min}$ ) a minimum of **two** times with rotary motion. If the bore hole ground is not reached, a brush extension must be used.

2c.

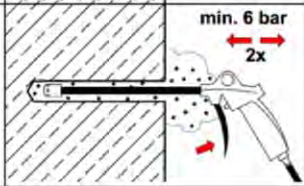

Starting from the bottom or back of the bore hole, blow out the hole with compressed air (min. 6 bar) again a minimum of **two** times until return air stream is free of noticeable dust. If the bore hole ground is not reached, an extension must be used.

### Injection System VHM for rebar connections



#### Intended use

Installation instruction  
Bore hole drilling and cleaning

Annex B9

## Installation instruction (continuation)

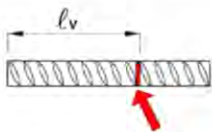
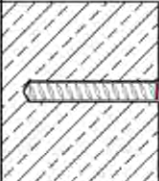
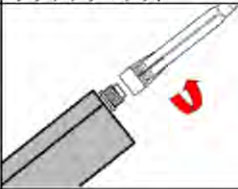
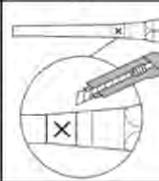
### Preparing and injection into borehole

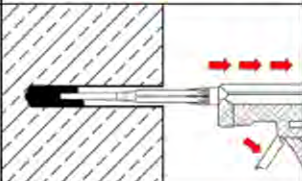
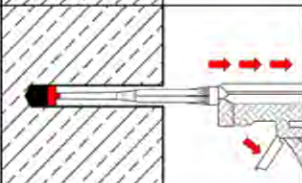
5		Mark the position of the embedment depth $l_v$ on the rebar.
6		Check drill hole depth by inserting rebar or anchor rod into the empty hole.
7		Prepare cartridge with static mixer (if necessary with extension pipe and retaining washer). Attach the supplied static-mixing nozzle to the cartridge and load the cartridge into the correct dispensing tool (Table B6). For every working interruption longer than the recommended working time (Table B3) as well as for new cartridges, a new static-mixer shall be used.
7a		When extension pipe VM-XLE 16 is used, the tip of the mixer has to be cut off at position „X“.
8		Prior to applying, discard mortar (forerun) until the mortar shows a consistent grey colour, but at least three full strokes. Never use this mortar!
9		Fill in injection mortar from the bottom of the clean borehole approx 2/3 air bubble free. Slowly moving the static mixer out of the borehole prevents the formation of air inclusions. For embedment larger than 190mm an extension pipe (Annex B6) must be used. Observe the working- and curing time given in table B3.
10		For overhead and horizontal installation and embedment larger than 240mm a retaining washer shall be used. Observe the working- and curing time given in table B3.

Injection System VHM for rebar connections





#### Intended use

Installation instruction (continuation)  
Preparing and injection into the borehole

Annex B10

## Installation instruction (continuation)

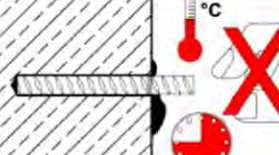
### Installation of rebar or tension anchor

11		<p>Immediately insert the rebar or tension anchor into the hole while turning slightly until the embedment depth is reached. The bar shall be free of dirt, grease and oil.</p>
12		<p>Excess injection mortar must exceed from the borehole, the annular gap shall be filled completely with mortar. If no mortar exceeds, these requirements are not maintained and the application has to be renewed. For overhead installation fix embedment part (e.g. wedges).</p>
13		<p>Ensure the curing time of the injection mortar according to table B3. Attention: the working time may vary due to different underground temperatures (Table B3). Do not move or load the anchor or rebar until curing time.</p>
14		<p>After the curing time (Table B3) the threaded rod or reinforcing bar can be load.</p>

Injection System VHM for rebar connections

#### Intended use

Installation instruction (continuation)  
Installation of rebar or tension anchor

Annex B11

## Minimum anchorage length and minimum lap length

The minimum anchorage length  $\ell_{b,min}$  and the minimum lap length  $\ell_{0,min}$  according to EN 1992-1-1:2004+AC:2010 ( $\ell_{b,min}$  acc. to Eq. 8.6 and Eq. 8.7 and  $\ell_{0,min}$  acc. to Eq. 8.11) shall be multiplied by the amplification factor  $\alpha_{lb}$  acc. to Table C1.

**Table C1: Amplification factor  $\alpha_{lb}$  depending on concrete strength class and drilling method**

Concrete strength class	Drilling method	Rod diameter	Amplification factor $\alpha_{lb}$ [-]
C12/15 to C50/60	hammer drilling vacuum drilling compressed air drilling	Ø8 to Ø32 ZA-M12 to ZA-M24	1,0

**Table C2: Reduction factor  $k_b$  for all drilling methods**

Rod diameter		Concrete strength class								
		C12/15	C16/20	C20/25	C25/30	C30/37	C35/45	C40/50	C45/55	C50/60
Ø8 to Ø32 ZA-M12 to ZA-M24	$k_b$ [-]	1,0								

**Table C3: Design values of the ultimate bond stress  $f_{bd,PIR}$  in N/mm<sup>2</sup> for all drilling methods and for good bond conditions**

$$f_{bd,PIR} = k_b \cdot f_{bd}$$

with

$f_{bd}$ : Design value of the ultimate bond stress in N/mm<sup>2</sup> considering the concrete strength classes and the rebar diameter according to EN 1992-1-1:2004+AC:2010 (for all other bond conditions multiply the values by 0,7)

$k_b$ : Reduction factor according to Table C2

Rod diameter		Concrete strength class								
		C12/15	C16/20	C20/25	C25/30	C30/37	C35/45	C40/50	C45/55	C50/60
Ø8 to Ø32 ZA-M12 to ZA-M24	$f_{bd,PIR}$ [N/mm <sup>2</sup> ]	1,6	2,0	2,3	2,7	3,0	3,4	3,7	4,0	4,3

**Injection System VHM** for rebar connections

### Performances

Amplification factor  $\alpha_{lb}$

Design values of ultimate bond resistance  $f_{bd,PIR}$

**Annex C1**

## Design value of ultimate bond stress $f_{bd,fi}$ under fire exposure for concrete classes C12/15 to C50/60 (all drilling methods):

The design value of ultimate bond stress  $f_{bd,fi}$  under fire exposure will be calculated by the following equation:

$$f_{bd,fi} = k_{fi}(\theta) \cdot f_{bd,PIR} \cdot \gamma_c / \gamma_{M,fi}$$

$$\text{with: } \theta \leq 364^\circ\text{C: } k_{fi}(\theta) = 30,34 \cdot \theta^{(\theta^*-0,011)} / (f_{bd,PIR} \cdot 4,3) \leq 1,0$$

$$\theta > 364^\circ\text{C: } k_{fi}(\theta) = 0$$

$f_{bd,fi}$  design value of ultimate bond stress in case of fire in N/mm<sup>2</sup>

$\theta$  Temperature in °C in the mortar layer

$k_{fi}(\theta)$  Reduction factor under fire exposure

$f_{bd,PIR}$  Design value of the ultimate bond stress in N/mm<sup>2</sup> in cold condition according to Table C2 considering concrete class, rebar diameter, drilling method and the bond conditions according to EN 1992-1-1:2004+AC:2010.

$\gamma_c$  partial factor acc. to EN 1992-1-1:2004+AC:2010

$\gamma_{M,fi}$  partial factor acc. to EN 1992-1-2:2004+AC:2008

For evidence under fire exposure the anchorage length shall be calculated according to EN 1992-1-1:2004+AC:2010 Equation 8.3 using the temperature-dependent ultimate bond stress  $f_{bd,fi}$ .

**Figure C1: Example graph of reduction factor  $k_{fi}(\theta)$**   
Concrete strength class C20/25 for good bond conditions

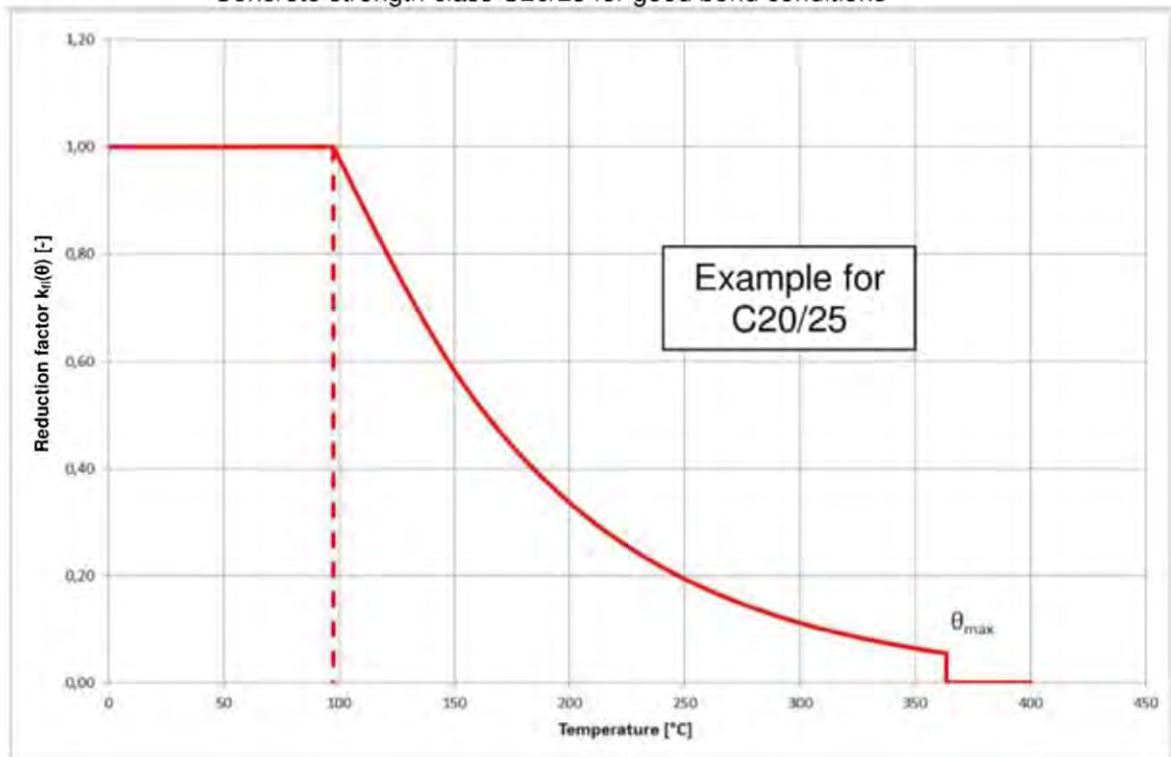

Injection System VHM for rebar connections

### Performances

Design value of ultimate bond stress  $f_{bd,fi}$  under fire exposure for rebar

Annex C2

**Table C4: Characteristic tension strength in case of fire for tension anchor ZA,**  
concrete strength class C12/15 to C50/60, acc. to Technical Report TR 020

Tension anchor ZA		M12	M16	M20	M24
<b>Steel failure</b>					
<b>Steel, zinc plated</b>					
Characteristic tension strength	R30	$\sigma_{Rk,s,fi}$ [N/mm <sup>2</sup> ]	20		
	R60		15		
	R90		13		
	R120		10		
<b>Stainless steel A4, HCR</b>					
Characteristic tension strength	R30	$\sigma_{Rk,s,fi}$ [N/mm <sup>2</sup> ]	30		
	R60		25		
	R90		20		
	R120		16		

**Design value of the tension strength  $\sigma_{Rd,s,fi}$  under fire exposure for tension anchor ZA**

The design value of the steel strength  $\sigma_{Rd,s,fi}$  under fire exposure will be calculated by the following equation:

$$\sigma_{Rd,s,fi} = \sigma_{Rk,s,fi} / \gamma_{M,fi}$$

with:

$\sigma_{Rk,s,fi}$  characteristic steel strength acc. to Table C4

$\gamma_{M,fi}$  partial factor under fire exposure acc. to EN 1992-1-2:2004+AC:2008

**Injection System VHM** for rebar connections

**Performances**

Steel strength for tension anchor ZA under fire exposure

**Annex C3**