

DÉCLARATION DES PERFORMANCES

Numéro de DoP: **MKT-2.2-100_fr**

- ◇ **Code d'identification unique du produit type:** **Système d'injection VMU plus pour la maçonnerie**
- ◇ **Usage(s) prévu(s):** Système d'injection pour ancrage dans la maçonnerie, voir l'annexe / Annex B
- ◇ **Fabricant:** MKT Metall-Kunststoff-Technik GmbH & Co.KG
Auf dem Immel 2
67685 Weilerbach
- ◇ **Le ou les systèmes d'évaluation et de vérification de la constance des performances du produit de construction:** 1
- ◇ **Document d'évaluation européen:** **ETAG 029**
Évaluation technique européenne: **ETA-13/0909, 08.12.2016**
Organisme d'évaluation technique: **DIBt, Berlin**
Organisme(s) notifié(s): **NB 2873 – Technische Universität Darmstadt**
- ◇ **Performance(s) déclarée(s):**

Caractéristiques essentielles	Performances
Résistance mécanique et stabilité (BWR 1)	
Facteur de réduction pour les essais sur chantier (facteur β)	Annexe / Annex C1
Capacité de charge caractéristique des éléments en acier	Annexe / Annex C2
Capacité de charge caractéristique des chevilles dans la maçonnerie	Annexe / Annex C3 – C45
Déplacements (charges de traction et de cisaillement)	Annexe / Annex C4 – C45
Distances au bord et au centre	Annexe / Annex C3 – C45
Facteur de groupe pour les fixations de groupe	Annexe / Annex C3 – C45
Sécurité en cas d'incendie (BWR 2)	
Le comportement du feu	Classe A1
Résistance au feu	Performances non déterminées

Les performances du produit identifié ci-dessus sont conformes aux performances déclarées. Conformément au règlement (UE) no 305/2011, la présente déclaration des performances est établie sous la seule responsabilité du fabricant mentionné ci-dessus.

Signé pour le fabricant et en son nom par:



Stefan Weustenhagen
(Directeur général)
Weilerbach, 01.01.2021

p.p.



Dipl.-Ing. Detlef Bigalke
(Directeur du développement
de produits)



L'original de cette déclaration des performances a été rédigé en allemand. En cas de divergences dans la traduction, la version allemande fait foi.

Specifications of intended use

Anchorage subject to:

- Static and quasi-static loads

Base material:

- Autoclaved Aerated Concrete (use category d) according to Annex B2
- Solid brick masonry (use category b), according to Annex B2.
- Hollow brick masonry (use category c), according to Annex B2 and B3.
- Mortar strength class of the masonry M 2,5 at minimum according to EN 998-2:2010.
- For other bricks in solid masonry and in hollow or perforated masonry, the characteristic resistance of the anchor may be determined by job site tests according to ETAG 029, Annex B under consideration of the β factor according to Annex C1, Table C1

Note: The characteristic resistance for solid bricks and autoclaved aerated concrete are also valid for larger brick sizes and larger compressive strength of the masonry unit.

Temperature range:

- T_a : - 40°C to +40°C (max. short term temperature +40°C and max. long term temperature +24°C)
- T_b : - 40°C to +80°C (max. short term temperature +80°C and max. long term temperature +50°C)
- T_c : - 40°C to +120°C (max. short term temperature +120°C and max. long term temperature +72°C)

Use conditions (Environmental conditions):

- Dry and wet structure (regarding injection mortar).
- Structures subject to dry internal conditions (zinc coated steel, stainless steel or high corrosion resistant steel).
- Structures subject to external atmospheric exposure (including industrial and marine environment) and to permanently damp internal condition, if no particular aggressive conditions exist (stainless steel or high corrosion resistant steel).
- Structures subject to external atmospheric exposure and to permanently damp internal condition, if other particular aggressive conditions exist (high corrosion resistant steel).

Note: Particular aggressive conditions are e.g. permanent, alternating immersion in seawater or the splash zone of seawater, chloride atmosphere of indoor swimming pools or atmosphere with extreme chemical pollution (e.g. in desulphurization plants or road tunnels where de-icing materials are used).

Use categories in respect of installation and use:

- Category d/d: Installation and use in dry masonry
- Category w/d: Installation in wet masonry and use in dry masonry
- Category w/w: Installation and use in dry or wet masonry

Design:

- Verifiable calculation notes and drawings are prepared taking account the relevant masonry in the region of the anchorage, the loads to be transmitted and their transmission to the supports of the structure. The position of the anchor is indicated on the design drawings.
- The anchorages are designed in accordance with the ETAG 029, Annex C, Design method A under the responsibility of an engineer experienced in anchorages and masonry work.

Characteristic values	$N_{Rk,s}$ $V_{Rk,s}$	$N_{Rk,p} = N_{Rk,b}$ $V_{Rk,b}$ and $V_{Rk,c}$	$N_{Rk,pb}$ $V_{Rk,pb}$
Determination acc. to	Annex C3	Annex C4 to C45	ETAG 029, Annex C

- For application with sleeve with drill bit size ≤ 15 mm installed in joints not filled with mortar:
 $N_{Rk,p,j} = 0,18 * N_{Rk,p}$ and $N_{Rk,b,j} = 0,18 * N_{Rk,b}$ ($N_{Rk,p} = N_{Rk,b}$ see Annex C4 to C45)
 $V_{Rk,c,j} = 0,15 * V_{Rk,c}$ and $V_{Rk,b,j} = 0,15 * V_{Rk,b}$ ($V_{Rk,b}$ and $V_{Rk,c}$ see Annex C4 to C45)
- Application without sleeve installed in joints not filled with mortar is not allowed.

Installation:





- Dry or wet structures
- Drill method acc. to Annex C4 to C45.
- Anchor Installation carried out by appropriately qualified personnel and under the supervision of the person responsible for technical matters of the site.
- When using anchor rods with internal thread (VMU-IG) fastening screws or threaded rods (incl. nut and washer) must comply with the appropriate material and property class of the Internal threaded rod.

Injection System VMU plus for masonry

Intended Use
Specifications

Annex B1

Table B1: Overview brick types and properties with corresponding fastening elements (Anchor and sleeve)

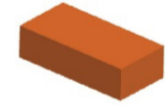
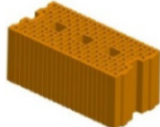
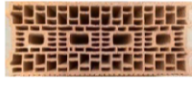
Brick-No.	Brick type	Picture	Brick size	Compressive strength	Bulk density	Sleeve - Anchor type	Annex
			length width height				
Autoclaved aerated concrete units according EN 771-4							
1	Autoclaved aerated concrete AAC6		499 240 249	6	0,6	M8/M10/M12/M16 IG-M6/IG-M8/IG-M10	C4 - C5
Calcium silicate masonry units according EN 771-2							
2	Calcium silicate solid brick KS-NF		240 115 71	10 20 27	2,0	M8/M10/M12/M16/IG-M6/IG-M8/IG-M10 VM-SH 12x80 – M8 VM-SH 16x85 – M8/M10/IG-M6 VM-SH 16x130 – M8/M10/IG-M6 VM-SH 20x85 – M12/M16/IG-M8/IG-M10 VM-SH 20x130 – M12/M16/IG-M8/IG-M10 VM-SH 20x200 – M12/M16/IG-M8/IG-M10	C6 - C8
3	Calcium silicate hollow brick KSL-3DF		240 175 113	8 12 14	1,4	VM-SH 12x80 – M8 VM-SH 16x85 – M8/M10/IG-M6 VM-SH 16x130 – M8/M10/IG-M6 VM-SH 20x85 – M12/M16/IG-M8/IG-M10 VM-SH 20x130 – M12/M16/IG-M8/IG-M10 VM-SH 20x200 – M12/M16/IG-M8/IG-M10	C9 - C11
4	Calcium silicate hollow brick KSL-12DF		498 175 238	10 12 16	1,4	VM-SH 12x80 – M8 VM-SH 16x85 – M8/M10/IG-M6 VM-SH 16x130 – M8/M10/IG-M6 VM-SH 20x85 – M12/M16/IG-M8/IG-M10 VM-SH 20x130 – M12/M16/IG-M8/IG-M10	C12 - C14
Clay masonry units according EN 771-1							
5	Clay solid brick Mz – DF		240 115 55	10 20 28	1,6	M8/M10/M12/M16/IG-M6/IG-M8/IG-M10 VM-SH 12x80 – M8 VM-SH 16x85 – M8/M10/IG-M6 VM-SH 16x130 – M8/M10/IG-M6 VM-SH 20x85 – M12/M16/IG-M8/IG-M10 VM-SH 20x130 – M12/M16/IG-M8/IG-M10 VM-SH 20x200 – M12/M16/IG-M8/IG-M10	C15 - C17
6	Clay hollow brick HLZ-16DF		497 240 238	6 8 12 14	0,8	VM-SH 12x80 – M8 VM-SH 16x85 – M8/M10/IG-M6 VM-SH 16x130 – M8/M10/IG-M6 VM-SH 20x85 – M12/M16/IG-M8/IG-M10 VM-SH 20x130 – M12/M16/IG-M8/IG-M10 VM-SH 20x200 – M12/M16/IG-M8/IG-M10	C18 - C20
7	Clay hollow brick Porothersm Homebric		500 200 299	4 6 10	0,7	VM-SH 12x80 – M8 VM-SH 16x85 – M8/M10/IG-M6 VM-SH 16x130 – M8/M10/IG-M6 VM-SH 20x85 – M12/M16/IG-M8/IG-M10 VM-SH 20x130 – M12/M16/IG-M8/IG-M10	C21 - C23









Injection System VMU plus for masonry

Intended use

Brick types and properties with corresponding fastening elements

Annex B2

Table B1: Overview brick types and properties with corresponding fastening elements (Anchor and sleeve) – continue

Brick-No.	Brick type	Picture	Brick size	Compressive strength	Bulk density	Sleeve - Anchor type	Annex
			length width height				
Clay masonry units according EN 771-1							
8	Clay hollow brick BGV Thermo		500 200 314	4 6 10	0,6	VM-SH 12x80 – M8 VM-SH 16x85 – M8/M10/IG-M6 VM-SH 16x130 – M8/M10/IG-M6 VM-SH 20x85 – M12/M16/IG-M8/IG-M10 VM-SH 20x130 – M12/M16/IG-M8/IG-M10	C24 - C26
9	Clay hollow brick Calibric R+		500 200 314	6 9 12	0,6	VM-SH 12x80 – M8 VM-SH 16x85 – M8/M10/IG-M6 VM-SH 16x130 – M8/M10/IG-M6 VM-SH 20x85 – M12/M16/IG-M8/IG-M10 VM-SH 20x130 – M12/M16/IG-M8/IG-M10	C27 - C29
10	Clay hollow brick Urbanbric		560 200 274	6 9 12	0,7	VM-SH 12x80 – M8 VM-SH 16x85 – M8/M10/IG-M6 VM-SH 16x130 – M8/M10/IG-M6 VM-SH 20x85 – M12/M16/IG-M8/IG-M10 VM-SH 20x130 – M12/M16/IG-M8/IG-M10	C30 - C32
11	Clay hollow brick Brique creuse C40		500 200 200	4 8 12	0,7	VM-SH 12x80 – M8 VM-SH 16x85 – M8/M10/IG-M6 VM-SH 16x130 – M8/M10/IG-M6 VM-SH 20x85 – M12/M16/IG-M8/IG-M10 VM-SH 20x130 – M12/M16/IG-M8/IG-M10	C33 - C35
12	Clay hollow brick Blocchi Leggeri		250 120 250	4 6 8 12	0,6	VM-SH 12x80 – M8 VM-SH 16x85 – M8/M10/IG-M6 VM-SH 16x130 – M8/M10/IG-M6 VM-SH 20x85 – M12/M16/IG-M8/IG-M10 VM-SH 20x130 – M12/M16/IG-M8/IG-M10 VM-SH 20x200 – M12/M16/IG-M8/IG-M10	C36 - C38
13	Clay hollow brick Doppio Uni		250 120 120	10 16 20 28	0,9	VM-SH 12x80 – M8 VM-SH 16x85 – M8/M10/IG-M6 VM-SH 16x130 – M8/M10/IG-M6 VM-SH 20x85 – M12/M16/IG-M8/IG-M10 VM-SH 20x130 – M12/M16/IG-M8/IG-M10 VM-SH 20x200 – M12/M16/IG-M8/IG-M10	C39 - C41
Lightweight concrete according EN 771-3							
14	Hollow lightweight concrete Bloc creux B40		494 200 190	4	0,8	VM-SH 12x80 – M8 VM-SH 16x85 – M8/M10/IG-M6 VM-SH 16x130 – M8/M10/IG-M6 VM-SH 20x85 – M12/M16/IG-M8/IG-M10 VM-SH 20x130 – M12/M16/IG-M8/IG-M10	C42 - C43
15	Solid lightweight concrete		300 123 248	2	0,6	M8/M10/M12/M16/IG-M6/IG-M8/IG-M10 VM-SH 12x80 – M8 VM-SH 16x85 – M8/M10/IG-M6 VM-SH 16x130 – M8/M10/IG-M6 VM-SH 20x85 – M12/M16/IG-M8/IG-M10 VM-SH 20x130 – M12/M16/IG-M8/IG-M10 VM-SH 20x200 – M12/M16/IG-M8/IG-M10	C44 - C45

Injection System VMU plus for masonry

Intended use

Brick types and properties with corresponding fastening elements

Annex B3

Installation: Steel brush

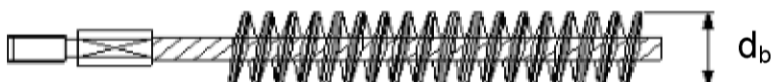

Table B2: Installation parameters in autoclaved aerated concrete AAC and solid masonry (without sleeve)

Anchor type and size		[mm]	VMU-A M8	VMU-A M10	VMU-IG M6	VMU-A M12	VMU-IG M8	VMU-A M16	VMU-IG M10
			V-A M8	V-A M10		V-A M12		V-A M16	
Nominal drill hole diameter	d_0	[mm]	10	12		14		18	
Drill hole depth	h_0	[mm]	80	90		100		100	
Effective anchorage depth	h_{ef}	[mm]	80	90		100		100	
Minimum wall thickness	h_{min}	[mm]	$h_{ef} + 30$						
Diameter of clearance hole in the fixture	$d_f \leq$	[mm]	9	12	7	14	9	18	12
Diameter of steel brush	d_b	[mm]	12	14		16		20	
Min. diameter of steel brush	$d_{b,min}$	[mm]	10,5	12,5		14,5		18,5	
Max. installation torque moment	$T_{inst,max}$	[Nm]	2 (14 for Mz DF)						

Table B3: Installation parameters in solid and hollow masonry (with sleeve)

Anchor size		[mm]	M8	M8 / M10 / IG-M6		M12 / M16 IG-M8 IG-M10		
Sleeve			12x80	16x85	16x130	20x85	20x130	20x200
Nominal drill hole diameter	d_0	[mm]	12	16		20		
Drill hole depth	h_0	[mm]	85	90	135	90	135	205
Effective anchorage depth	h_{ef}	[mm]	80	85	130	85	130	200
Minimum wall thickness	h_{min}	[mm]	115	115	175	115	175	240
Diameter of clearance hole in the fixture	$d_f \leq$	[mm]	9	7 (IG-M6) 9 (M8) 12 (M10)		9 (IG-M8) 12 (IG-M10) 14 (M12) 18 (M16)		
Diameter of steel brush	d_b	[mm]	14	18		22		
Min. diameter of steel brush	$d_{b,min}$	[mm]	12,5	16,5		20,5		
Max. installation torque moment	$T_{inst,max}$	[Nm]	2					

Injection System VMU plus for masonry

Intended use

Cleaning brush and installation parameters

Annex B4

**Table B4: Maximum working time and minimum curing time
VMU plus**

Temperature in the base material	Temperature of cartridge	Working time	Minimum curing time in dry base material ¹⁾
-10 °C to - 6 °C	+ 15 °C to + 40 °C	90 min	24 h
- 5 °C to - 1 °C	+ 5 °C to + 40 °C	90 min	14 h
0 °C to + 4 °C		45 min	7 h
+ 5 °C to + 9 °C		25 min	2 h
+ 10 °C to + 19 °C		15 min	80 min
+ 20 °C to + 29 °C		6 min	45 min
+ 30 °C to + 34 °C		4 min	25 min
+ 35 °C to + 39 °C		2 min	20 min
+ 40 °C		1,5 min	15 min

¹⁾ In wet base material the curing time **must** be doubled.

**Table B5: Maximum working time and minimum curing time
VMU plus Polar**

Temperature in the base material	Temperature of cartridge	Working time	Minimum curing time in dry base material ¹⁾
-20 °C to - 16 °C	-20 °C to +10 °C	75 min	24 h
- 15 °C to - 11 °C		55 min	16 h
- 10 °C to - 6 °C		35 min	10 h
- 5 °C to - 1 °C		20 min	5 h
0 °C to + 4 °C		10 min	2,5 h
+ 5 °C to + 9 °C		6 min	80 min
+ 10 °C		6 min	60 min

¹⁾ In wet base material the curing time **must** be doubled.

Injection System VMU plus for masonry

Intended Use
Working and curing time

Annex B5

Installation Instruction - Solid masonry without sleeve

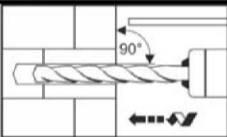
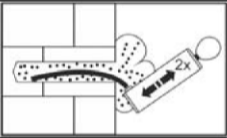
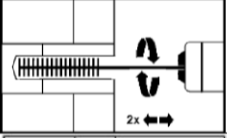
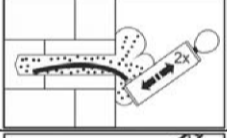
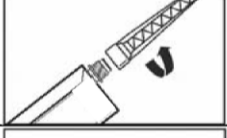
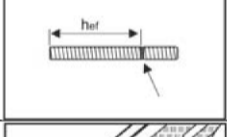
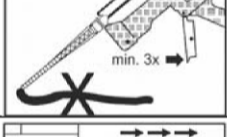
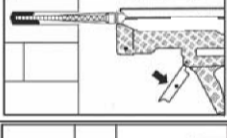
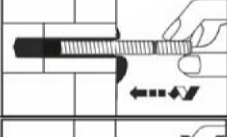
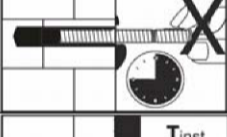
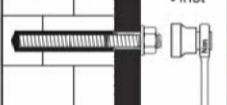
1.		<p>Drill hole perpendicular to the surface of base material with drill method according to Annex C4-C45, with nominal drill hole diameter and bore hole depth according to the size and embedment depth required by the selected anchor. In case of aborted drill hole the hole shall be filled with mortar.</p>
2a.		<p>Drill hole must be cleaned prior to installation of the anchor.</p> <p>Blow out from the bottom of the bore hole two times.</p>
2b.		<p>Attach the appropriate sized brush (acc.to Annex B4) to a drilling machine or a battery screwdriver, brush the hole clean two times.</p>
2c.		<p>Finally blow out the hole again two times.</p>
3.		<p>Remove the cap and attach the supplied static-mixing nozzle to the cartridge and load the cartridge into the correct dispensing tool. In case of a foil tube cartridge, cut off the clip before use. For every working interruption longer than the recommended working time (Table B4 or B5) as well as for new cartridges, a new static-mixer shall be used.</p>
4.		<p>The position of the embedment depth shall be marked on the threaded rod. The anchor rod shall be free of dirt, grease, oil or other foreign material.</p>
5.		<p>Initial adhesive is not suitable for fixing the anchor. Prior to dispensing into the anchor hole, squeeze out separately a minimum of three full strokes, for foil tube cartridges six full strokes and discard non-uniformly mixed adhesive components until the mortar shows a consistent grey color.</p>
6.		<p>Starting from the bottom or back of the cleaned anchor hole, fill up the hole to min two-thirds with adhesive. Slowly withdraw the static mixing nozzle will avoid creating air pockets. Observe the working times given in Table B4 and B5.</p>
7.		<p>Push the threaded rod into the anchor hole while turning slightly to ensure positive distribution of the adhesive until the embedment depth is reached. Be sure that the annular gap is fully filled with mortar. If no excess mortar is visible at the top of the hole, the application has to be renewed.</p>
8.		<p>Allow the adhesive to cure to the specified curing time given in Table B4 or B5. Do not move or load the anchor until it is fully cured. After curing time remove access mortar.</p>
9.		<p>After full curing, the fixture can be installed with up to the max. installation torque acc. to Table B2 or B3 with calibrated torque wrench.</p>



Injection System VMU plus for masonry

Intended Use

Installation instructions (Solid masonry without sleeve)

Annex B6

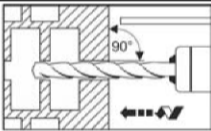
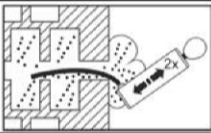
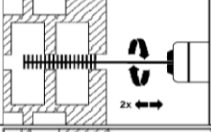
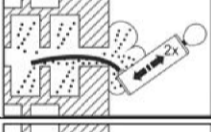
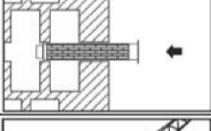
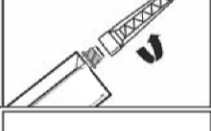
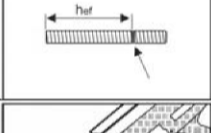
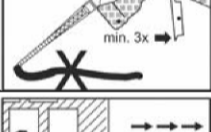
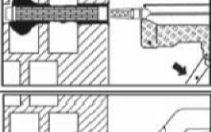
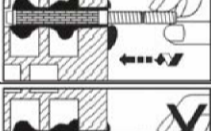
Installation Instructions - Solid or hollow masonry - with sleeve

1.		Drill hole perpendicular to the surface of base material with drill method according to Annex C4-C45, with nominal drill hole diameter and bore hole depth according to the size and embedment depth required by the selected anchor. In case of aborted drill hole the drill hole shall be filled with mortar.
2a.		Drill hole must be cleaned prior to installation of the anchor. Blow out from the bottom of the bore hole two times.
2b.		Attach the appropriate sized brush (acc.to Annex B4) to a drilling machine or a battery screwdriver, brush the hole clean two times.
2c.		Finally blow out the hole again two times.
3.		Insert the perforated sleeve flush with the surface of the masonry or plaster. Only use sleeves that have the right length. Never cut the sleeve.
4.		Remove the cap and attach the supplied static-mixing nozzle to the cartridge and load the cartridge into the correct dispensing tool. In case of a foil tube cartridge, cut off the clip before use. For every working interruption longer than the recommended working time (Table B4 or B5) as well as for new cartridges, a new static-mixer shall be used.
5.		The position of the embedment depth shall be marked on the threaded rod. The anchor rod shall be free of dirt, grease, oil or other foreign material.
6.		Initial adhesive is not suitable for fixing the anchor. Prior to dispensing into the anchor hole, squeeze out separately a minimum of three full strokes, for foil tube cartridges six full strokes and discard non-uniformly mixed adhesive components until the mortar shows a consistent grey colour.
7.		Starting from the bottom or back fill the sleeve with adhesive. For embedment depth equal to or larger than 130 mm an extension nozzle shall be used. For quantity of mortar attend cartridges label installation instructions. Observe the working times given in Table B4 or B5.
8.		Push the threaded rod into the anchor hole while turning slightly to ensure positive distribution of the adhesive until the embedment depth is reached.
9.		Allow the adhesive to cure to the specified curing time given in Table B4 or B5. Do not move or load the anchor until it is fully cured. After curing time remove access mortar.
10.		After full curing, the fixture can be installed with up to the max. installation torque acc. to Table B2 and B3 with calibrated torque wrench.

Injection System VMU plus for masonry

Intended Use

Installation Instruction (Solid or hollow masonry - with sleeve)

Annex B7

Table C1: β - factor for job-site testing under tension loading

Brick-No. and abbreviation	Installation & Use category	β -Factor					
		$T_a: 40^\circ\text{C} / 24^\circ\text{C}$		$T_b: 80^\circ\text{C} / 50^\circ\text{C}$		$T_c: 120^\circ\text{C} / 72^\circ\text{C}$	
		d/d	w/d w/w	d/d	w/d w/w	d/d	w/d w/w
1 AAC6	All sizes	0,95	0,86	0,81	0,73	0,81	0,73
2 KS-NF	$d_0 \leq 14$ mm	0,93	0,80	0,87	0,74	0,65	0,56
	$d_0 \geq 16$ mm	0,93	0,93	0,87	0,87	0,65	0,65
3 KSL-3DF	$d_0 \leq 12$ mm	0,93	0,80	0,87	0,74	0,65	0,56
	$d_0 \geq 16$ mm	0,93	0,93	0,87	0,87	0,65	0,65
4 KSL-12DF	$d_0 \leq 12$ mm	0,93	0,80	0,87	0,74	0,65	0,56
	$d_0 \geq 16$ mm	0,93	0,93	0,87	0,87	0,65	0,65
5 MZ-DF	all sizes	0,86	0,86	0,86	0,86	0,73	0,73
6 Hz-16DF							
7 Porotherm Homebric							
8 BGV-Thermo							
9 Calibric R+							
10 Urbanbric							
11 Brique creuse C40							
12 Blocchi Leggeri							
13 Doppio Uni							
14 Bloc creux B40							
15 Solid lightweight concrete	$d_0 \leq 12$ mm	0,93	0,80	0,87	0,74	0,65	0,56
	$d_0 \geq 16$ mm	0,93	0,93	0,87	0,87	0,65	0,65

Injection System VMU plus for masonry

Performances

β - factors for job site testing under tension load

Annex C1

Table C2: Characteristic steel resistance under tension and shear load

Anchor type			VMU-IG			VMU-A, V-A			
			M6	M8	M10	M8	M10	M12	M16
Characteristic tension resistance									
Steel, property class 4.6	$N_{RK,s}$	[kN]	-	-	-	15	23	34	63
	γ_{Ms}	[-]				2,0			
Steel, property class 4.8	$N_{RK,s}$	[kN]	-	-	-	15	23	34	63
	γ_{Ms}	[-]				1,5			
Steel, property class 5.6	$N_{RK,s}$	[kN]	10	18	29	18	29	42	79
	γ_{Ms}	[-]	2,0			2,0			
Steel, property class 5.8	$N_{RK,s}$	[kN]	10	17	29	18	29	42	79
	γ_{Ms}	[-]	1,5			1,5			
Steel, property class 8.8	$N_{RK,s}$	[kN]	16	27	46	29	46	67	126
	γ_{Ms}	[-]	1,5			1,5			
Stainless steel A4 / HCR, property class 70	$N_{RK,s}$	[kN]	14	26	41	26	41	59	110
	γ_{Ms}	[-]	1,87			1,87			
Stainless steel A4 / HCR, property class 80	$N_{RK,s}$	[kN]	16	29	46	29	46	67	126
	γ_{Ms}	[-]	1,6			1,6			
Characteristic shear resistance									
Steel, property class 4.6	$V_{RK,s}$	[kN]	-	-	-	7	12	17	31
	γ_{Ms}	[-]				1,67			
Steel, property class 4.8	$V_{RK,s}$	[kN]	-	-	-	7	12	17	31
	γ_{Ms}	[-]				1,25			
Steel, property class 5.6	$V_{RK,s}$	[kN]	5	9	15	9	15	21	39
	γ_{Ms}	[-]	1,67			1,67			
Steel, property class 5.8	$V_{RK,s}$	[kN]	5	9	15	9	15	21	39
	γ_{Ms}	[-]	1,25			1,25			
Steel, property class 8.8	$V_{RK,s}$	[kN]	8	14	23	15	23	34	63
	γ_{Ms}	[-]	1,25			1,25			
Stainless steel A4 / HCR, property class 70	$V_{RK,s}$	[kN]	7	13	20	13	20	30	55
	γ_{Ms}	[-]	1,56			1,56			
Stainless steel A4 / HCR, property class 80	$V_{RK,s}$	[kN]	8	15	23	15	23	34	63
	γ_{Ms}	[-]	1,33			1,33			
Characteristic bending moment									
Steel, property class 4.6	$M_{RK,s}$	[Nm]	-	-	-	15	30	52	133
	γ_{Ms}	[-]				1,67			
Steel, property class 4.8	$M_{RK,s}$	[Nm]	-	-	-	15	30	52	133
	γ_{Ms}	[-]				1,25			
Steel, property class 5.6	$M_{RK,s}$	[Nm]	8	19	37	19	37	66	167
	γ_{Ms}	[-]	1,67			1,67			
Steel, property class 5.8	$M_{RK,s}$	[Nm]	8	19	37	19	37	66	167
	γ_{Ms}	[-]	1,25			1,25			
Steel, property class 8.8	$M_{RK,s}$	[Nm]	12	30	60	30	60	105	266
	γ_{Ms}	[-]	1,25			1,25			
Stainless steel A4 / HCR, property class 70	$M_{RK,s}$	[Nm]	11	26	52	26	52	92	233
	γ_{Ms}	[-]	1,56			1,56			
Stainless steel A4 / HCR, property class 80	$M_{RK,s}$	[Nm]	12	30	60	30	60	105	266
	γ_{Ms}	[-]	1,33			1,33			

Injection System VMU plus for masonry
Performances

Characteristic steel resistance under tension and shear load

Annex C2

Spacing and edge distance

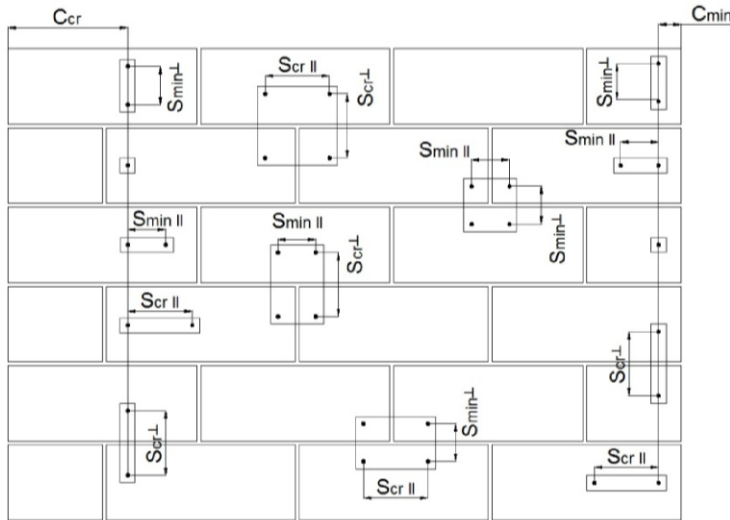

C_{cr} = Characteristic edge distance
 C_{min} = Minimum edge distance
 S_{cr} = Characteristic spacing
 S_{min} = Minimum spacing

$S_{cr,II}; (S_{min,II})$ = Characteristic (minimum) spacing for anchors placed parallel to bed joint
 $S_{cr,\perp}; (S_{min,\perp})$ = Characteristic (minimum) spacing for anchors placed perpendicular to bed joint

Anchor position	Load direction		
	Tension load	Shear load parallel to free edge	Shear load perpendicular to free edge
Anchors places parallel to bed joint $S_{cr,II}; (S_{min,II})$			
Anchors places perpendicular to bed joint $S_{cr,\perp}; (S_{min,\perp})$			

$\alpha_{g,N,II}$ = Group factor in case of tension load for anchors placed parallel to the bed joint
 $\alpha_{g,V,II}$ = Group factor in case of shear load for anchors placed parallel to the bed joint
 $\alpha_{g,N,\perp}$ = Group factor in case of tension load for anchors placed perpendicular to the bed joint
 $\alpha_{g,V,\perp}$ = Group factor in case of shear load for anchors placed perpendicular to the bed joint

Group of 2 anchors: $N_{RK}^g = \alpha_{g,N} * N_{RK}$ and $V_{RK}^g = \alpha_{g,V} * V_{RK}$

Group of 4 anchors: $N_{RK}^g = \alpha_{g,N,II} * \alpha_{g,N,\perp} * N_{RK}$ and $V_{RK}^g = \alpha_{g,V,II} * \alpha_{g,V,\perp} * V_{RK}$

(N_{RK} : $N_{RK,b}$ or $N_{RK,b,j}$ for C_{cr})

(V_{RK} : $V_{RK,c}$; $V_{RK,c,j}$; $V_{RK,b}$ or $V_{RK,b,j}$ for C_{cr})

(with the relevant α_g)

Injection System VMU plus for masonry

Performances

Edge distance and Spacing

Annex C3

Brick type: Autoclaved Aerated Concrete – AAC6

Table C3: Description of the brick

Brick type	Autoclaved Aerated Concrete AAC6		
Bulk density	ρ [kg/dm ³]	0,6	
Compressive strength	$f_b \geq$ [N/mm ²]	6	
Code	EN 771-4		
Producer (country code)	e.g. Porit (DE)		
Brick dimensions	[mm]	499 x 240 x 249	
Drilling method	Rotary		

Table C4: Spacing and edge distance

Anchor size			All sizes
Edge distance	C_{cr}	[mm]	$1,5 \cdot h_{ef}$
Minimum edge distance	$C_{min,N}$	[mm]	75
	$C_{min,V,II}$ ($C_{min,v,\perp}$) ¹⁾	[mm]	$75 (1,5 \cdot h_{ef})$
Spacing	S_{cr}	[mm]	$3 \cdot h_{ef}$
Minimum spacing	S_{min}	[mm]	100

¹⁾ $C_{min,v,II}$ for shear loading parallel to the free edge; $C_{min,v,\perp}$ for shear loading perpendicular free edge

Table C5: Group factor for anchor group in case of tension loading

Configuration		with c [mm] \geq	with s [mm] \geq			
II: anchors placed parallel to horizontal joint		125 (120 for M8)	100	$\alpha_{g,N,II}$	[-]	1,8
		$1,5 \cdot h_{ef}$	$3 \cdot h_{ef}$			2,0
⊥: anchors placed perpendicular to horizontal joint		75	100	$\alpha_{g,N,\perp}$		1,4
		$1,5 \cdot h_{ef}$	$3 \cdot h_{ef}$			2,0

Table C6: Group factor for anchor group in case of shear loading parallel to free edge

Configuration		with c [mm] \geq	with s [mm] \geq			
II: anchors placed parallel to horizontal joint		75	100	$\alpha_{g,V,II}$	[-]	1,2
		$1,5 \cdot h_{ef}$	$3 \cdot h_{ef}$			2,0
⊥: anchors placed perpendicular to horizontal joint		$1,5 \cdot h_{ef}$	$3 \cdot h_{ef}$	$\alpha_{g,V,\perp}$		2,0

Injection System VMU plus for masonry

Performances - Autoclaved Aerated Concrete - AAC6
Description of the brick, Spacing and edge distance, Group factors

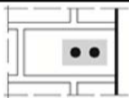
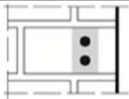
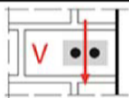
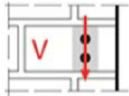
Annex C4

Brick type: Autoclaved Aerated Concrete – AAC6

Table C7: Group factor for anchor group in case of shear loading perpendicular to free edge

Configuration		with c [mm] \geq	with s [mm] \geq			
II: anchors placed parallel to horizontal joint		1,5*hef	3,0*hef	$\alpha_{g,V,II}$	[-]	2,0
I: anchors placed perpendicular to horizontal joint		1,5*hef	3,0*hef	$\alpha_{g,V,I}$		2,0

Table C8: Characteristic values of resistance under tension and shear loads

Anchor size	Effective anchorage depth	Characteristic resistance						
		Use category						
		d/d			w/w w/d			d/d w/d w/w
		40°C/24°C	80°C/50°C	120°C/72°C	40°C/24°C	80°C/50°C	120°C/72°C	All temperature ranges
hef	$N_{Rk,b} = N_{Rk,p}^{1)}$			$N_{Rk,b} = N_{Rk,p}^{1)}$			$V_{Rk,b}^{2)3)}$	
[mm]	[kN]							
Compressive strength $f_b \geq 6 \text{ N/mm}^2$								
M8	80	2,5 (2,0)	2,5 (1,5)	2,0 (1,2)	2,5 (1,5)	2,0 (1,5)	1,5 (1,2)	6,0
M10/IG-M6	90	4,0 (2,5)	3,0 (2,0)	2,5 (1,5)	3,5 (2,5)	3,0 (2,0)	2,5 (1,5)	10,0
M12/IG-M8	100	5,0 (3,5)	4,0 (3,0)	3,0 (2,5)	4,5 (3,0)	3,5 (2,5)	3,0 (2,5)	10,0
M16/IG-M10	100	6,5 (4,5)	5,5 (3,5)	4,0 (3,0)	5,5 (4,0)	5,0 (3,5)	4,0 (3,0)	10,0

¹⁾ Values are valid for c_{cr} , values in brackets are valid for single anchors with c_{min}

²⁾ For calculation of $V_{Rk,c}$ see ETAG029, Annex C;

³⁾ The values are valid for steel 5.6 or higher. For steel 4.6 and 4.8 multiply $V_{Rk,b}$ by 0,8

Table C9: Displacements

Anchor size	hef	N	δ_N / N	δ_{N0}	$\delta_{N\infty}$	V	δ_{V0}	$\delta_{V\infty}$
	[mm]	[kN]	[mm/kN]	[mm]	[mm]	[kN]	[mm]	[mm]
M8	80	0,9	0,18	0,16	0,32	1,3	0,8	1,20
M10/IG-M6	90	1,4		0,26	0,51	1,8	1,2	1,80
M12/IG-M8	100	1,8	0,08	0,14	0,29	2,1	1,4	2,10
M16/IG-M10	100	2,3		0,19	0,37	2,3	1,5	2,25

Injection System VMU plus for masonry

Performances - Autoclaved Aerated Concrete – AAC6
Group factor, Characteristic values of resistance, Displacements

Annex C5

Brick type: Calcium silicate solid brick KS-NF

Table C10: Description of the brick

Brick type	Calcium silicate solid brick KS-NF		
Bulk density	ρ [kg/dm ³]	2,0	
Compressive strength	$f_b \geq$ [N/mm ²]	10, 20 or 27	
Code	EN 771-2		
Producer (country code)	e.g. Wemding (DE)		
Brick dimensions	[mm]	240 x 115 x 71	
Drilling method	Hammer		

Table C11: Spacing and edge distance

Anchor size			All sizes
Edge distance	c_{cr}	[mm]	$1,5 \cdot h_{ef}$
Minimum edge distance	c_{min}	[mm]	60
Spacing	s_{cr}	[mm]	$3 \cdot h_{ef}$
Minimum spacing	s_{min}	[mm]	120

Table C12: Group factor for anchor group in case of tension loading

Configuration		with c [mm] \geq	with s [mm] \geq			
II: anchors placed parallel to horizontal joint		60	120	$\alpha_{g,N,II}$	[-]	1,0
		140	120			1,5
		$1,5 \cdot h_{ef}$	$3 \cdot h_{ef}$			2,0
⊥: anchors placed perpendicular to horizontal joint		60	120	$\alpha_{g,N,\perp}$	[-]	0,5
		$1,5 \cdot h_{ef}$	120			1,0
		$1,5 \cdot h_{ef}$	$3 \cdot h_{ef}$			2,0

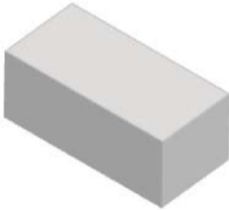
Table C13: Group factor for anchor group in case of shear loading parallel to free edge

Configuration		with c [mm] \geq	with s [mm] \geq			
II: anchors placed parallel to horizontal joint		60	120	$\alpha_{g,V,II}$	[-]	1,0
		115	120			1,7
		$1,5 \cdot h_{ef}$	$3 \cdot h_{ef}$			2,0
⊥: anchors placed perpendicular to horizontal joint		60	120	$\alpha_{g,V,\perp}$	[-]	1,0
		$1,5 \cdot h_{ef}$	120			1,0
		$1,5 \cdot h_{ef}$	$3 \cdot h_{ef}$			2,0

Table C14: Group factor for anchor group in case of shear loading perpendicular to free edge

Configuration		with c [mm] \geq	with s [mm] \geq			
II: anchors placed parallel to horizontal joint		60	120	$\alpha_{g,V,II}$	[-]	1,0
		$1,5 \cdot h_{ef}$	$3 \cdot h_{ef}$			2,0
⊥: anchors placed perpendicular to horizontal joint		60	120	$\alpha_{g,V,\perp}$	[-]	1,0
		$1,5 \cdot h_{ef}$	$3 \cdot h_{ef}$			2,0

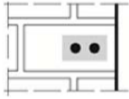
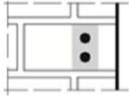
Injection System VMU plus for masonry

Performances - Calcium solid brick KS-NF
Description, Spacing and edge distance, Group factor

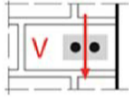
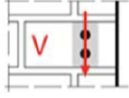
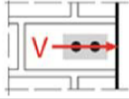
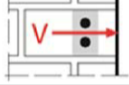
Annex C6

Brick type: Calcium silicate solid brick KS-NF

Table C15: Characteristic values of resistance under tension and shear loads

Anchor size	Sleeve	Effective anchorage depth [mm]	Characteristic resistance							
			Use category							
			d/d			w/d w/w			d/d w/d w/w	
			40°C/24°C	80°C/50°C	120°C/72°C	40°C/24°C	80°C/50°C	120°C/72°C	All temperature ranges	
h_{ef}	$N_{Rk,b} = N_{Rk,p}^{1)}$			$N_{Rk,b} = N_{Rk,p}^{1)}$			$V_{Rk,b}^{2)3)}$			
[kN]										
Compressive strength $f_b \geq 10 \text{ N/mm}^2$										
M8	-	80								2,5 (1,5)
M10 / IG-M6	-	90	4,5 (2,0)	4,5 (2,0)	3,0 (1,5)	3,5 (1,5)	3,5 (1,5)	2,5 (1,2)		3,0 (2,0)
M12 / IG-M8	-	100								2,5 (1,5)
M16 / IG-M10	-	100	3,5 (1,5)	3,5 (1,5)	2,5 (1,2)	3,0 (1,5)	3,5 (1,5)	2,0 (0,9)		2,5 (1,5)
M8	12x80	80	3,5 (1,5)	3,5 (1,5)	2,5 (1,2)	3,5 (1,5)	3,0 (1,5)	2,5 (1,2)		2,5 (1,5)
M8 / M10 / IG-M6	16x85	85	3,5 (1,5)	3,0 (1,5)	2,0 (0,9)	3,5 (1,5)	3,0 (1,5)	2,5 (1,2)		2,5 (1,5)
	16x130	130	3,5 (1,5)	3,0 (1,5)	2,0 (0,9)	3,5 (1,5)	3,0 (1,5)	2,5 (1,2)		2,5 (1,5)
M12 / M16 / IG-M8 / IG-M10	20x85	85								
	20x130	130	3,0 (1,5)	2,5 (1,2)	2,0 (0,9)	3,0 (1,5)	2,5 (1,2)	2,0 (0,9)		2,5 (1,5)
	20x200	200								
Compressive strength $f_b \geq 20 \text{ N/mm}^2$										
M8	-	80								4,0 (2,5)
M10 / IG-M6	-	90	6,0 (3,0)	5,5 (2,5)	4,0 (2,0)	5,0 (2,5)	5,0 (2,5)	3,5 (1,5)		4,5 (2,5)
M12 / IG-M8	-	100								4,0 (2,5)
M16 / IG-M10	-	100	5,0 (2,5)	5,0 (2,5)	3,5 (1,5)	5,0 (2,5)	5,0 (2,5)	3,5 (1,5)		4,0 (2,5)
M8	12x80	80	5,5 (2,5)	5,0 (2,5)	3,5 (1,5)	4,5 (2,0)	4,5 (2,0)	3,0 (1,5)		4,0 (2,5)
M8 / M10 / IG-M6	16x85	85	5,0 (2,5)	4,5 (2,0)	3,5 (1,5)	5,0 (2,5)	4,5 (2,0)	3,5 (1,5)		4,0 (2,5)
	16x130	130	5,0 (2,5)	4,5 (2,0)	3,5 (1,5)	5,0 (2,5)	4,5 (2,0)	3,5 (1,5)		4,0 (2,5)
M12 / M16 / IG-M8 / IG-M10	20x85	85								
	20x130	130	4,0 (2,0)	4,0 (2,0)	3,0 (1,5)	4,0 (2,0)	4,0 (2,0)	3,0 (1,5)		4,0 (2,5)
	20x200	200								

1) Values are valid for c_{gr} , values in brackets are valid for single anchors with c_{min}
 2) For c_{gr} calculation of $V_{Rk,c}$ see ETAG 029, Annex C; values in brackets $V_{Rk,c} = V_{Rk,b}$ for single anchors with c_{min}
 3) The values are valid for steel 5.6 or higher. For steel 4.6 and 4.8 multiply $V_{Rk,b}$ by 0,8.

Injection System VMU plus for masonry

Performances - Calcium solid brick KS-NF
 Characteristic values of resistance

Annex C7

Brick type: Calcium silicate solid brick KS-NF

Table C16: Characteristic values of resistance under tension and shear loads (continue)

Anchor size	Sleeve	Effective anchorage depth	Characteristic resistance						
			Use category						
			d/d			w/d w/w			d/d w/d w/w
			40°C/24°C	80°C/50°C	120°C/72°C	40°C/24°C	80°C/50°C	120°C/72°C	All temperature ranges
h_{ef}	$N_{Rk,b} = N_{Rk,p}^{1)}$			$N_{Rk,b} = N_{Rk,p}^{1)}$			$V_{Rk,b}^{2)3)}$		
[mm]	[kN]								
Compressive strength $f_b \geq 27 \text{ N/mm}^2$									
M8	-	80							4,5 (2,5)
M10 / IG-M6	-	90	7,0 (3,5)	6,5 (3,0)	5,0 (2,5)	6,0 (3,0)	5,5 (2,5)	4,0 (2,0)	5,5 (3,0)
M12 / IG-M8	-	100							4,5 (2,5)
M16 / IG-M10	-	100	6,0 (3,0)	5,5 (2,5)	4,5 (2,0)	6,0 (3,0)	5,5 (2,5)	4,0 (2,0)	4,5 (2,5)
M8	12x80	80	6,5 (3,0)	6,0 (3,0)	4,5 (2,0)	5,5 (2,5)	5,0 (2,5)	3,5 (1,5)	4,5 (2,5)
M8 / M10 / IG-M6	16x85	85	5,5 (2,5)	5,0 (2,5)	4,0 (2,0)	5,5 (2,5)	5,0 (2,5)	4,0 (2,0)	4,5 (2,5)
	16x130	130	5,5 (2,5)	5,0 (2,5)	4,0 (2,0)	5,5 (2,5)	5,0 (2,5)	4,0 (2,0)	4,5 (2,5)
M12 / M16 / IG-M8 / IG-M10	20x85	85							
	20x130	130	5,0 (2,5)	4,5 (2,0)	3,5 (1,5)	5,0 (2,5)	4,5 (2,0)	3,5 (1,5)	4,5 (2,5)
	20x200	200							

1) Values are valid for c_{cr} , values in brackets are valid for single anchors with c_{min}

2) For c_{cr} calculation of $V_{Rk,c}$ see ETAG 029, Annex C; values in brackets $V_{Rk,c} = V_{Rk,b}$ for single anchors with c_{min}

3) The values are valid for steel 5.6 or higher. For steel 4.6 and 4.8 multiply $V_{Rk,b}$ by 0,8

Table C17: Displacements

Anchor size	Sleeve	h_{ef}	N	δ_N / N	δ_{N0}	$\delta_{N\infty}$	V	δ_{V0}	$\delta_{V\infty}$
		[mm]	[kN]	[mm/kN]	[mm]	[mm]	[kN]	[mm]	[mm]
M8	-	80					1,7	0,90	1,35
M10 / IG-M6	-	90	2,0		0,30	0,60	2,0	1,10	1,65
M12 / IG-M8	-	100							
M16 / IG-M10	-	100	1,7	0,15	0,26	0,51			
M8	12x80	80							
	M8 / M10 / IG-M6	16x85	85	1,4	0,21	0,43	1,7	0,90	1,35
M12 / M16 / IG-M8 / IG-M10	16x130	130							
	20x85	85							
	20x130	130	1,3		0,19	0,39			
	20x200	200							

Injection System VMU plus for masonry

Performances - Calcium solid brick KS-NF
Characteristic values of resistance (continue), Displacements

Annex C8

Brick type: Calcium silicate hollow brick KSL-3DF

Table C18: Description of the brick

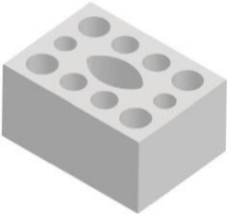
Brick type	Calcium silicate hollow brick KSL-3DF		
Bulk density	ρ [kg/dm ³]	1,4	
Compressive strength	$f_b \geq$ [N/mm ²]	8, 12 or 14	
Code	EN 771-2		
Producer (country code)	e.g. Wemding (DE)		
Brick dimensions	[mm]	240 x 175 x 113	
Drilling method	Rotary		

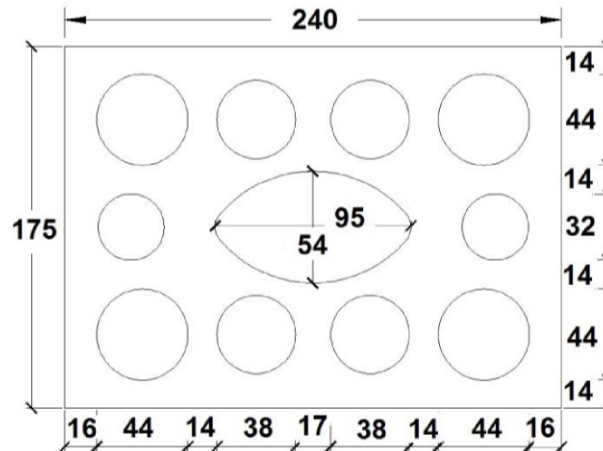
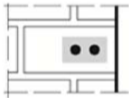
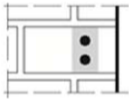

Table C19: Spacing and edge distance

Anchor size			All sizes
Edge distance	C_{cr}	[mm]	100 (120) ¹⁾
Minimum edge distance	C_{min}	[mm]	60
Spacing	$S_{cr,II}$	[mm]	240
	$S_{cr,I}$	[mm]	120
Minimum spacing	S_{min}	[mm]	120

¹⁾ Value in brackets for VM-SH 20x85; VM-SH 20x130 and VM-SH 20x200

Table C20: Group factor for anchor group in case of tension loading

Configuration		with c [mm] \geq	with s [mm] \geq			
II: anchors placed parallel to horizontal joint		60	120	$\alpha_{g,N,II}$	[-]	1,5
		C_{cr}	240			2,0
		160	120			2,0
I: anchors placed perpendicular to horizontal joint		60	120	$\alpha_{g,N,I}$	[-]	1,0
		C_{cr}	120			2,0

Injection System VMU plus for masonry

Performances - Calcium silicate hollow brick KSL-3DF
Description of the brick, Spacing and edge distance, Group factor

Annex C9

Brick type: Calcium silicate hollow brick KSL-3DF

Table C21: Group factor for anchor group in case of shear loading parallel to free edge

Configuration		with c [mm] ≥	with s [mm] ≥			
II: anchors placed parallel to horizontal joint		60	120	$\alpha_{g,V,II}$	[-]	1,0
		160	120			1,6
		c_{cr}	240			2,0
I: anchors placed perpendicular to horizontal joint		60	120	$\alpha_{g,V,I}$	[-]	1,0
		c_{cr}	120			2,0

Table C22: Group factor for anchor group in case of shear loading perpendicular to free edge

Configuration		with c [mm] ≥	with s [mm] ≥			
II: anchors placed parallel to horizontal joint		60	120	$\alpha_{g,V,II}$	[-]	1,0
		c_{cr}	240			2,0
I: anchors placed perpendicular to horizontal joint		60	120	$\alpha_{g,V,I}$	[-]	1,0
		c_{cr}	120			2,0

Table C23: Characteristic values of resistance under tension and shear loads

Anchor size	Sleeve	Effective anchorage depth	Characteristic resistance						
			Use category						
			d/d			w/d; w/w			d/d; w/d; w/w
			40°C/24°C	80°C/50°C	120°C/72°C	40°C/24°C	80°C/50°C	120°C/72°C	All temperature ranges
		h_{ef}	$N_{Rk,b} = N_{Rk,p}^{1)}$			$N_{Rk,b} = N_{Rk,p}^{1)}$			$V_{Rk,b}^{4)}$
		[mm]	[kN]						
Compressive strength $f_b \geq 8 \text{ N/mm}^2$									
M8	12x80	80					1,2	0,9	$2,5^{2)} (0,9)^{3)}$
M8 / M10 / IG-M6	16x85	85	1,5	1,5	1,2	1,5	1,5	1,2	$4,0^{2)} (1,5)^{3)}$
	16x130	130					1,5	1,2	$4,0^{2)} (1,5)^{3)}$
M12 / M16 / IG-M8 / IG-M10	20x85	85							
	20x130	130	4,5	4,0	3,0	4,5	4,0	3,0	$4,0^{2)} (1,5)^{3)}$
	20x200	200							
Compressive strength $f_b \geq 12 \text{ N/mm}^2$									
M8	12x80	80	2,0	2,0	1,5	2,0	1,5	1,2	$3,0^{2)} (1,2)^{3)}$
M8 / M10 / IG-M6	16x85	85	2,0	2,0	1,5	2,0	2,0	1,5	$4,5^{2)} (1,5)^{3)}$
	16x130	130	2,5	2,5	1,5	2,5	2,5	1,5	$4,5^{2)} (1,5)^{3)}$
M12 / M16 / IG-M8 / IG-M10	20x85	85							
	20x130	130	6,0	5,5	4,0	6,0	5,5	4,0	$4,5^{2)} (1,5)^{3)}$
	20x200	200							

1) Values are valid for c_{cr} and c_{min}

2) $V_{Rk,c,II} = V_{Rk,b}$ valid for shear load parallel to free edge

3) $V_{Rk,c,I} = V_{Rk,b}$ (values in brackets) valid for shear load in direction to free edge

4) The values are valid for steel 5.6 or higher. For steel 4.6 and 4.8 multiply $V_{Rk,b}$ by 0,8

Injection System VMU plus for masonry

Performances - Calcium silicate hollow brick KSL-3DF
Group factor, Characteristic values of resistance

Annex C10

Brick type: Calcium silicate hollow brick KSL-3DF

Table C24: Characteristic values of resistance under tension and shear loads (continue)

Anchor size	Sleeve	Effective anchorage depth	Characteristic resistance							
			Use category							
			d/d			w/d; w/w			d/d; w/d; w/w	
			40°C/24°C	80°C/50°C	120°C/72°C	40°C/24°C	80°C/50°C	120°C/72°C	All temperature ranges	
h_{ef}	$N_{Rk,b} = N_{Rk,p}^{1)}$			$N_{Rk,b} = N_{Rk,p}^{1)}$			$V_{Rk,b}^{4)}$			
[mm]	[kN]									
Compressive strength $f_b \geq 14 \text{ N/mm}^2$										
M8	12x80	80	2,5	2,5	1,5	2,0	2,0	1,5	3,5 ²⁾ (1,5) ³⁾	
M8 / M10 / IG-M6	16x85	85	2,5	2,5	1,5	2,5	2,5	1,5	6,0 ²⁾ (2,0) ³⁾	
	16x130	130	2,5	2,5	2,0	2,5	2,5	2,0	6,0 ²⁾ (2,0) ³⁾	
M12 / M16 / IG-M8 / IG-M10	20x85	85	6,5	6,0	4,5	6,5	6,0	4,5	6,0 ²⁾ (2,0) ³⁾	
	20x130	130								
	20x200	200								

- 1) Values are valid for c_{gr} and c_{min}
 2) $V_{Rk,c,II} = V_{Rk,b}$ valid for shear load parallel to free edge
 3) $V_{Rk,c,I} = V_{Rk,b}$ (values in brackets) valid for shear load in direction to free edge
 4) The values are valid for steel 5.6 or higher. For steel 4.6 and 4.8 multiply $V_{Rk,b}$ by 0,8

Table C25: Displacements

Anchor size	Sleeve	h_{ef}	N	δ_N / N	δ_{N0}	$\delta_{N\infty}$	V	δ_{V0}	$\delta_{V\infty}$
		[mm]							
M8	12x80	80	0,71	0,90	0,64	1,29	1,0	1,0	1,50
M8 / M10 / IG-M6	16x85	85							
		16x130	130						
M12 / M16 / IG-M8 / IG-M10	20x85	85	1,86	0,90	1,67	3,34	1,7	1,9	2,85
	20x130	130							
	20x200	200							

Injection System VMU plus for masonry

Performance - Calcium silicate hollow brick KSL-3DF
 Characteristic values of resistance, Displacements

Annex C11

Brick type: Calcium silicate hollow brick KSL-12DF

Table C26: Description of the brick

Brick type	Calcium silicate hollow brick KSL-12DF		
Bulk density	ρ [kg/dm ³]	1,4	
Compressive strength	$f_b \geq$ [N/mm ²]	10, 12 or 16	
Code	EN 771-2		
Producer (country code)	e.g. Wemding (DE)		
Brick dimensions	[mm]	498 x 175 x 238	
Drilling method	Rotary		

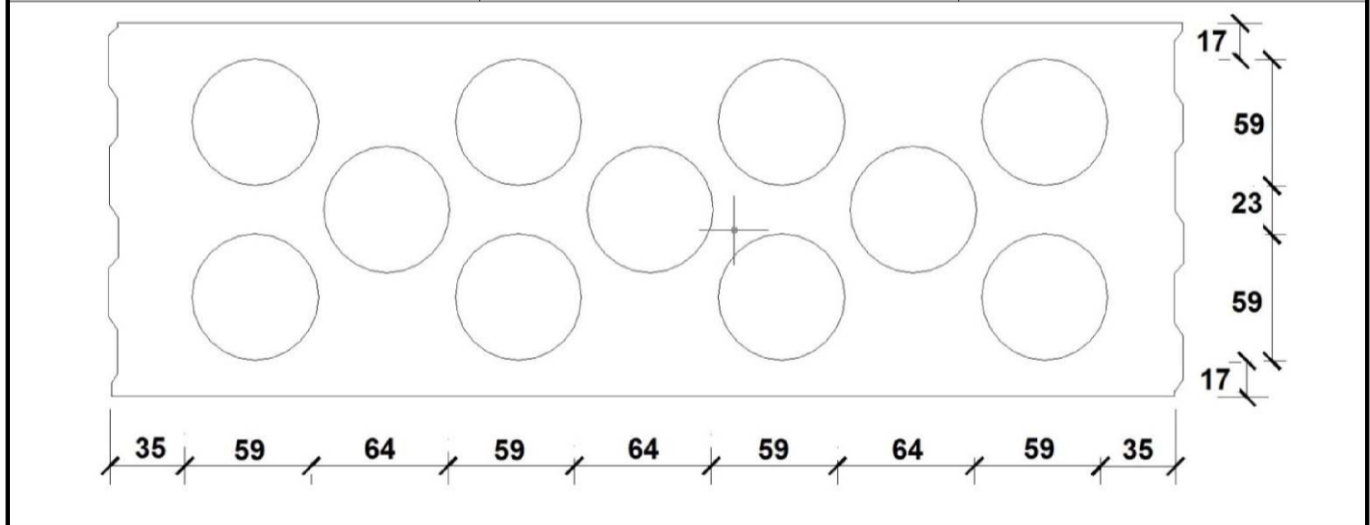



Table C27: Spacing and edge distances

Anchor size			All sizes
Edge distance	c_{cr}	[mm]	100 (120) ¹⁾
Minimum edge distance	c_{min} ²⁾	[mm]	100 (120) ¹⁾
Spacing	$s_{cr,II}$	[mm]	498
	$s_{cr,\perp}$	[mm]	238
Minimum spacing	s_{min}	[mm]	120

1) Value in brackets for VM-SH 20x85 and VM-SH 20x130

2) For $V_{Rk,c}$: c_{min} according to ETAG 029, Annex C

Table C28: Group factor for anchor group in case of tension loading

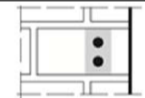
Configuration		with c [mm] \geq	with s [mm] \geq			
II: anchors placed parallel to horizontal joint		100	120	$\alpha_{g,N,II}$	[-]	1,0
		c_{cr}	498			2,0
⊥: anchors placed perpendicular to horizontal joint		100	120	$\alpha_{g,N,\perp}$	[-]	1,0
		c_{cr}	238			2,0

Injection System VMU plus for masonry

Performance - Calcium silicate hollow brick KSL-12DF
 Description of the brick, Spacing and edge distances, Group factor

Annex C12

Brick type: Calcium silicate hollow brick KSL-12DF

Table C29: Group factor for anchor group in case of shear loading parallel to free edge

Configuration		with c [mm] ≥	with s [mm] ≥			
II: anchors placed parallel to horizontal joint		C_{Cr}	498	$\alpha_{g,V,II}$	[-]	2,0
I: anchors placed perpendicular to horizontal joint		C_{Cr}	238	$\alpha_{g,V,I}$		2,0

Table C30: Group factor for anchor group in case of shear load perpendicular to free edge

Configuration		with c [mm] ≥	with s [mm] ≥			
II: anchors placed parallel to horizontal joint		C_{Cr}	498	$\alpha_{g,V,II}$	[-]	2,0
I: anchors placed perpendicular to horizontal joint		C_{Cr}	238	$\alpha_{g,V,I}$		2,0

Table C31: Characteristic values of resistance under tension and shear loads

Anchor size	Sleeve	Effective anchorage depth	Characteristic resistance						
			Use category						
			d/d			w/d; w/w			d/d w/d w/w
			40°C/24°C	80°C/50°C	120°C/72°C	40°C/24°C	80°C/50°C	120°C/72°C	All temperature ranges
		h_{ef}	$N_{Rk,b} = N_{Rk,p}^{1)}$			$N_{Rk,b} = N_{Rk,p}^{1)}$			$V_{Rk,b}^{2)3)}$
		[mm]	[kN]						
Compressive strength $f_b \geq 10 \text{ N/mm}^2$									
M8	12x80	80	0,6	0,6	0,4	0,5	0,5	0,4	2,5
M8 / M10 / IG-M6	16x85	85	0,6	0,6	0,4	0,6	0,6	0,4	5,5
	16x130	130	2,5	2,5	2,0	2,5	2,5	2,0	5,5
M12 / M16 / IG-M8 / IG-M10	20x85	85	1,5	1,5	0,9	1,5	1,5	0,9	5,5
	20x130	130	2,5	2,5	2,0	2,5	2,5	2,0	5,5
Compressive strength $f_b \geq 12 \text{ N/mm}^2$									
M8	12x80	80	0,75	0,6	0,5	0,6	0,6	0,4	3,0
M8 / M10 / IG-M6	16x85	85	0,75	0,6	0,5	0,75	0,6	0,5	6,5
	16x130	130	3,0	3,0	2,0	3,0	3,0	2,0	6,5
M12 / M16 / IG-M8 / IG-M10	20x85	85	1,5	1,5	1,2	1,5	1,5	1,2	6,5
	20x130	130	3,0	3,0	2,0	3,0	3,0	2,0	6,5

1) Values are valid for C_{Cr} and C_{min}

2) Calculation of $V_{Rk,c}$ see ETAG 029, Annex C, except for shear load parallel to free edge with $c \geq 120 \text{ mm}$: $V_{Rk,c,II} = V_{Rk,b}$

3) The values are valid for steel 5.6 or higher. For steel 4.6 and 4.8 multiply $V_{Rk,b}$ by 0,8

Injection System VMU plus for masonry

Performance - Calcium silicate hollow brick KSL-12DF

Group factor, Characteristic values of resistance

Annex C13

Brick type: Calcium silicate hollow brick KSL-12DF

Table C32: Characteristic values of resistance under tension and shear loads (continue)

Anchor size	Sleeve	Effective anchorage depth	Characteristic resistance						
			Use category						
			d/d			w/d; w/w			d/d w/d w/w
			40°C/24°C	80°C/50°C	120°C/72°C	40°C/24°C	80°C/50°C	120°C/72°C	All temperature ranges
			$N_{Rk,b} = N_{Rk,p}^{1)}$			$N_{Rk,b} = N_{Rk,p}^{1)}$			$V_{Rk,b}^{2)3)}$
h_{ef}		[kN]							
[mm]		Compressive strength $f_b \geq 16 \text{ N/mm}^2$							
M8	12x80	80	0,9	0,9	0,6	0,75	0,75	0,5	3,5
M8 / M10 / IG-M6	16x85	85	0,9	0,9	0,6	0,9	0,9	0,6	8,0
	16x130	130	4,0	3,5	2,5	4,0	3,5	2,5	8,0
M12 / M16 / IG-M8 / IG-M10	20x85	85	2,0	2,0	1,5	2,0	2,0	1,5	8,0
	20x130	130	4,0	3,5	2,5	4,0	3,5	2,5	8,0

1) Values are valid for c_{gr} and c_{min}

2) Calculation of $V_{Rk,c}$ see ETAG 029, Annex C, except for shear load parallel to free edge with $c \geq 120 \text{ mm}$: $V_{Rk,c,II} = V_{Rk,b}$

3) The values are valid for steel 5.6 or higher. For steel 4.6 and 4.8 multiply $V_{Rk,b}$ by 0,8

Table C33: Displacements

Anchor size	Sleeve	h_{ef}	N	δ_N / N	δ_{N0}	$\delta_{N\infty}$	V	δ_{V0}	$\delta_{V\infty}$
		[mm]	[kN]	[mm/kN]	[mm]	[mm]	[kN]	[mm]	[mm]
M8	12x80	80	0,26	0,90	0,23	0,46	1,0	1,3	1,95
M8 / M10 / IG-M6	16x85	85			1,03	2,06	2,3	2,5	3,75
	16x130	130	0,51		1,03				
M12 / M16 / IG-M8 / IG-M10	20x85	85	0,57		1,03	2,06			
	20x130	130	1,14	1,03	2,06				

Injection System VMU plus for masonry

Performance - Calcium silicate hollow brick KSL-12DF
Characteristic values of resistance (continue), Displacements

Annex C14

Brick type: Clay solid brick Mz-DF

Table C34: Description of the brick

Brick type	Clay solid brick Mz-DF		
Bulk density	ρ [kg/dm ³]	1,6	
Compressive strength	$f_b \geq$ [N/mm ²]	10, 20 or 28	
Code	EN 771-1		
Producer (country code)	e.g. Unipor (DE)		
Brick dimensions	[mm]	240 x 115 x 55	
Drilling method	Hammer		

Table C35: Spacing and edge distances

Anchor size			Alle Größen
Edge distance	c_{cr}	[mm]	$1,5 \cdot h_{ef}$
Minimum edge distance	c_{min}	[mm]	60
Spacing	s_{cr}	[mm]	$3 \cdot h_{ef}$
Minimum spacing	s_{min}	[mm]	120

Table C36: Group factor for anchor group in case of tension loading

Configuration		with c [mm] \geq	with s [mm] \geq			
II: anchors placed parallel to horizontal joint 		60	120	$\alpha_{g,N,II}$	[-]	0,7
		$1,5 \cdot h_{ef}$	$3 \cdot h_{ef}$			2,0
I: anchors placed perpendicular to horizontal joint 		60	120	$\alpha_{g,N,I}$		0,5
		$1,5 \cdot h_{ef}$	120			1,0
		$1,5 \cdot h_{ef}$	$3 \cdot h_{ef}$		2,0	

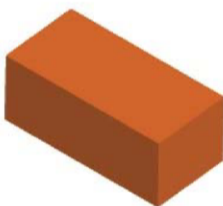
Table C37: Group factor for anchor group in case of shear loading parallel to free edge



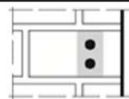

Configuration		with c [mm] \geq	with s [mm] \geq			
II: anchors placed parallel to horizontal joint 		60	120	$\alpha_{g,V,II}$	[-]	0,5
		90	120			1,1
		$1,5 \cdot h_{ef}$	$3 \cdot h_{ef}$			2,0
I: anchors placed perpendicular to horizontal joint 		60	120	$\alpha_{g,V,I}$		0,5
		$1,5 \cdot h_{ef}$	120			1,0
		$1,5 \cdot h_{ef}$	$3 \cdot h_{ef}$			2,0

Table C38: Group factor for anchor group in case of shear load perpendicular to free edge

Configuration		with c [mm] \geq	with s [mm] \geq			
II: anchors placed parallel to horizontal joint 		60	120	$\alpha_{g,V,II}$	[-]	0,5
		$1,5 \cdot h_{ef}$	120			1,0
		$1,5 \cdot h_{ef}$	$3 \cdot h_{ef}$			2,0
I: anchors placed perpendicular to horizontal joint 		60	120	$\alpha_{g,V,I}$		0,5
		$1,5 \cdot h_{ef}$	120			1,0
		$1,5 \cdot h_{ef}$	$3 \cdot h_{ef}$			2,0

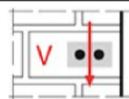
Injection System VMU plus for masonry

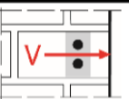
Performance - Clay solid brick Mz-DF

Description of the brick , Spacing and edge distances, Group factor

Annex C15

Brick type: Clay solid brick Mz-DF

Table C39: Characteristic values of resistance under tension and shear loads

Anchor size	Sleeve	Effective Anchorage depth	Characteristic resistance			
			Use category			
			d/d w/d w/w			d/d w/d w/w
			40°C/24°C	80°C/50°C	120°C/72°C	All temperature ranges
h_{ef} [mm]	$N_{Rk,b} = N_{Rk,p}^{1)}$			$V_{Rk,b}^{2)3)}$		
[kN]						
Compressive strength $f_b \geq 10 \text{ N/mm}^2$						
M8	-	80	3,5 (1,5)	3,5 (1,5)	2,5 (1,2)	3,5 (1,2)
M10 / IG-M6	-	90	3,5 (1,5)	3,5 (1,5)	3,0 (1,5)	3,5 (1,2)
M12 / IG-M8	-	100	4,0 (2,0)	4,0 (2,0)	3,5 (1,5)	3,5 (1,2)
M16 / IG-M10	-	100	4,0 (2,0)	4,0 (2,0)	3,5 (1,5)	5,5 (1,5)
M8	12x80	80	3,5 (1,5)	3,5 (1,5)	3,0 (1,2)	3,5 (1,2)
M8 / M10 / IG-M6	16x85	85	3,5 (1,5)	3,5 (1,5)	3,0 (1,5)	3,5 (1,2)
	16x130	130				
M12 / M16 / IG-M8 / IG-M10	20x85	85				
	20x130	130				
	20x200	200				
Compressive strength $f_b \geq 20 \text{ N/mm}^2$						
M8	-	80	4,5 (2,5)	4,5 (2,5)	4,0 (2,0)	5,0 (1,5)
M10 / IG-M6	-	90	5,5 (2,5)	5,5 (2,5)	4,5 (2,0)	5,0 (1,5)
M12 / IG-M8	-	100	6,0 (3,0)	6,0 (3,0)	5,0 (2,5)	5,0 (1,5)
M16 / IG-M10	-	100	6,0 (3,0)	6,0 (3,0)	5,0 (2,5)	8,0 (2,5)
M8	12x80	80	4,5 (2,5)	4,5 (2,5)	4,0 (2,0)	5,0 (1,5)
M8 / M10 / IG-M6	16x85	85	5,0 (2,5)	5,0 (2,5)	4,0 (2,0)	5,0 (1,5)
	16x130	130				
M12 / M16 / IG-M8 / IG-M10	20x85	85				
	20x130	130				
	20x200	200				
Compressive strength $f_b \geq 28 \text{ N/mm}^2$						
M8	-	80	5,5 (2,5)	5,5 (2,5)	4,5 (2,5)	5,5 (2,0)
M10 / IG-M6	-	90	6,0 (3,0)	6,0 (3,0)	5,0 (2,5)	5,5 (2,0)
M12 / IG-M8	-	100	7,0 (3,5)	7,0 (3,5)	6,0 (3,0)	5,5 (2,0)
M16 / IG-M10	-	100	7,0 (3,5)	7,0 (3,5)	6,0 (3,0)	9,0 (3,0)
M8	12x80	80	5,5 (2,5)	5,5 (2,5)	4,5 (2,5)	5,5 (2,0)
M8 / M10 / IG-M6	16x85	85	6,0 (3,0)	6,0 (3,0)	5,0 (2,5)	5,5 (2,0)
	16x130	130				
M12 / M16 / IG-M8 / IG-M10	20x85	85				
	20x130	130				
	20x200	200				

1) Values are valid for c_{cr} , values in brackets are valid for single anchors with c_{min}
 2) For c_{cr} calculation of $V_{Rk,c}$ see ETAG 029, Annex C; for c_{min} values in brackets $V_{Rk,c} = V_{Rk,b}$
 3) The values are valid for steel 5.6 or higher. For steel 4.6 and 4.8 multiply $V_{Rk,b}$ by 0,8.

Injection System VMU plus for masonry

Performance - Clay solid brick Mz-DF
 Characteristic values of resistance

Annex C16

Brick type: Clay solid brick Mz-DF

Table C40: Displacements

Anchor size	Sleeve	h_{ef}	N	$\tilde{\delta}_N / N$	$\tilde{\delta}_{N0}$	$\tilde{\delta}_{N\infty}$	V	$\tilde{\delta}_{V0}$	$\tilde{\delta}_{V\infty}$
		[mm]	[kN]	[mm/kN]	[mm]	[mm]	[kN]	[mm]	[mm]
M8	-	80	1,3	0,15	0,19	0,39	1,9	1,00	1,50
M10 / IG-M6	-	90	1,6		0,24	0,47			
M12 / IG-M8	-	100	1,7		0,26	0,51			
M16 / IG-M10	-	100							
M8	12x80	80	1,3		0,19	0,39	1,9		
M8 / M10 / IG-M6	16x85	85							
	16x130	130							
M12 / M16 / IG-M8 / IG-M10	20x85	85							
	20x130	130							
	20x200	200							

Injection System VMU plus for masonry

Performance - Clay solid brick Mz-DF
Displacements

Annex C17

Brick type: Clay hollow brick HLz-16-DF

Table C41: Description of the brick

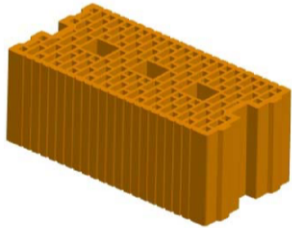
Brick type	Clay hollow brick HLz-16-DF		
Bulk density	ρ [kg/dm ³]	0,8	
Compressive strength	$f_b \geq$ [N/mm ²]	6, 8, 12 or 14	
Code	EN 771-1		
Producer (country code)	e.g. Unipor (DE)		
Brick dimensions	[mm]	497 x 240 x 238	
Drilling method	Rotary		

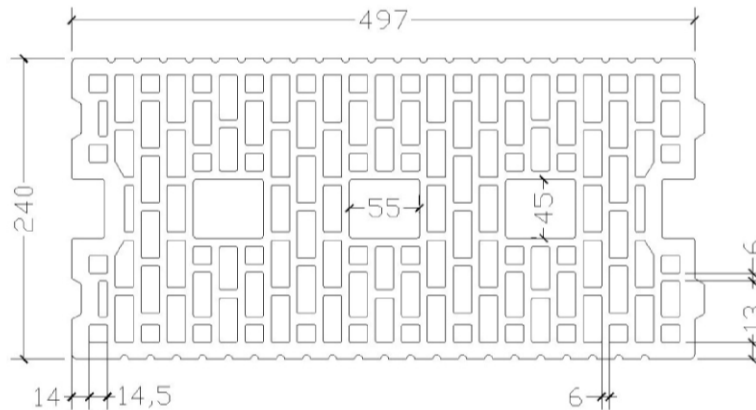

Table C42: Spacing and edge distances

Anchor size			All sizes
Edge distance	c_{cr}	[mm]	100 (120) ¹⁾
Minimum edge distance	c_{min} ²⁾	[mm]	100 (120) ¹⁾
Spacing	$s_{cr,II}$	[mm]	497
	$s_{cr,I}$	[mm]	238
Minimum spacing	s_{min}	[mm]	100

1) Value in bracket for VM-SH 20x85; VM-SH 20x130 and VM-SH 20x200

2) For $V_{Rk,c}$: c_{min} according to ETAG 029, Annex C

Table C43: Group factor for anchor group in case of tension loading

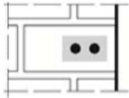
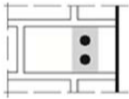
Configuration		with c [mm] \geq	with s [mm] \geq			
II: anchors placed parallel to horizontal joint		c_{cr}	100	$\alpha_{g,N,II}$	[-]	1,3
		c_{cr}	497			2,0
I: anchors placed perpendicular to horizontal joint		c_{cr}	100	$\alpha_{g,N,I}$	[-]	1,1
		c_{cr}	238			2,0

Injection System VMU plus for masonry

Performance - Clay hollow brick HLz-16DF

Description of the brick, Spacing and edge distances, Group factor

Annex C18

Brick type: Clay hollow brick HLz-16-DF

Table C44: Group factor for anchor group in case of shear loading parallel to free edge

Configuration		with c [mm] ≥	with s [mm] ≥			
II: anchors placed parallel to horizontal joint		C_{cr}	497	$\alpha_{g,V,II}$	[-]	2,0
I: anchors placed perpendicular to horizontal joint		C_{cr}	238	$\alpha_{g,V,I}$		2,0

Table C45: Group factor for anchor group in case of shear load perpendicular to free edge

Configuration		with c [mm] ≥	with s [mm] ≥			
II: anchors placed parallel to horizontal joint		C_{cr}	497	$\alpha_{g,V,II}$	[-]	2,0
I: anchors placed perpendicular to horizontal joint		C_{cr}	238	$\alpha_{g,V,I}$		2,0

Table C46: Characteristic values of resistance under tension and shear loads

Anchor size	Sleeve	Effective Anchorage depth	Characteristic resistance			
			Use category			
			d/d w/d w/w			d/d w/d w/w
			40°C/24°C	80°C/50°C	120°C/72°C	All temperature ranges
h_{ef}	$N_{Rk,b} = N_{Rk,p}^{1)}$			$V_{Rk,b}^{2)3)}$		
[mm]	[kN]			[kN]		
Compressive strength $f_b \geq 6 \text{ N/mm}^2$						
M8	12x80	80	2,5	2,5	2,0	2,5
M8 / M10/ IG-M6	16x85	85	2,5	2,5	2,0	4,5
	16x130	130	3,5	3,5	3,0	4,5
M12 / M16 / IG-M8 / IG-M10	20x85	85	2,5	2,5	2,0	5,0
	20x130	130	3,5	3,5	3,0	6,0
	20x200	200	3,5	3,5	3,0	6,0
Compressive strength $f_b \geq 8 \text{ N/mm}^2$						
M8	12x80	80	3,0	3,0	2,5	3,0
M8 / M10/ IG-M6	16x85	85	3,0	3,0	2,5	5,5
	16x130	130	4,5	4,5	3,5	5,5
M12 / M16 / IG-M8 / IG-M10	20x85	85	3,0	3,0	2,5	6,0
	20x130	130	4,5	4,5	3,5	7,0
	20x200	200	4,5	4,5	3,5	7,0

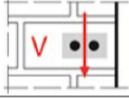
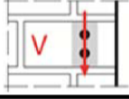
1) Values are valid for c_{cr} and c_{min}

2) Calculation of $V_{Rk,c}$ see ETAG 029, Annex C, except for shear load parallel to free edge with $c \geq 125 \text{ mm}$: $V_{Rk,c,II} = V_{Rk,b}$

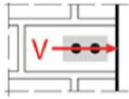
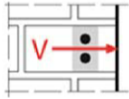
3) The values are valid for steel 5.6 or higher. For steel 4.6 and 4.8 multiply $V_{Rk,b}$ by 0,8

Injection System VMU plus for masonry

Performance - Clay hollow brick HLz-16DF
Group factor, Characteristic values of resistance

Annex C19

Brick type: Clay hollow brick HLz-16DF

Table C47: Characteristic values of resistance under tension and shear loads (continue)

Anchor size	Sleeve	Effective Anchorage depth	Characteristic resistance			
			Use category			
			d/d w/d w/w			d/d w/d w/w
			40°C/24°C	80°C/50°C	120°C/72°C	All temperature ranges
h_{ef} [mm]	$N_{Rk,b} = N_{Rk,p}^{1)}$ [kN]			$V_{Rk,b}^{2)3)}$ [kN]		
Compressive strength $f_b \geq 12 \text{ N/mm}^2$						
M8	12x80	80	3,5	3,5	3,0	4,0
M8 / M10/ IG-M6	16x85	85	3,5	3,5	3,0	6,5
	16x130	130	5,0	5,0	4,5	6,5
M12 / M16 / IG-M8 / IG-M10	20x85	85	3,5	3,5	3,0	7,0
	20x130	130	5,0	5,0	4,5	9,0
	20x200	200	5,0	5,0	4,5	9,0
Compressive strength $f_b \geq 14 \text{ N/mm}^2$						
M8	12x80	80	4,0	4,0	3,0	4,0
M8 / M10/ IG-M6	16x85	85	4,0	4,0	3,0	6,5
	16x130	130	5,5	5,5	4,5	6,5
M12 / M16 / IG-M8 / IG-M10	20x85	85	4,0	4,0	3,0	7,0
	20x130	130	5,5	5,5	4,5	9,0
	20x200	200	5,5	5,5	4,5	9,0

1) Values are valid for c_{cr} and c_{min}

2) Calculation of $V_{Rk,c}$ see ETAG 029, Annex C, except for shear load parallel to free edge with $c \geq 125 \text{ mm}$: $V_{Rk,c,II} = V_{Rk,b}$

3) The values are valid for steel 5.6 or higher. For steel 4.6 and 4.8 multiply $V_{Rk,b}$ by 0,8

Table C48: Displacements

Anchor size	Sleeve	h_{ef}	N	δ_N / N	δ_{N0}	$\delta_{N\infty}$	V	δ_{V0}	$\delta_{V\infty}$
		[mm]	[kN]	[mm/kN]	[mm]	[mm]	[kN]	[mm]	[mm]
M8	12x80	80	1,14	0,10	0,11	0,23	1,10	1,20	1,80
M8 / M10/ IG-M6	16x85	85					1,86	1,50	2,25
	16x130	130	1,57		1,50	2,25			
M12 / M16 / IG-M8 / IG-M10	20x85	85	1,14		0,11	0,23	1,86	1,50	2,25
	20x130	130	1,57		0,16	0,31	2,57	2,10	3,15
	20x200	200							

Injection System VMU plus for masonry

Performance - Clay hollow brick HLz-16DF

Characteristic values of resistance (continue), Displacements

Annex C20

Brick type: Clay hollow brick Porotherm Homebric

Table C49: Description of the brick

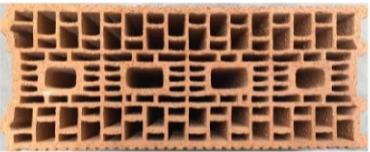
Brick type	Clay hollow brick Porotherm Homebric		
Bulk density	ρ [kg/dm ³]	0,7	
Compressive strength	$f_b \geq$ [N/mm ²]	4, 6 or 10	
Code	EN 771-1		
Producer (country code)	e.g. Wienerberger (FR)		
Brick dimensions	[mm]	500 x 200 x 299	
Drilling method	Rotary		

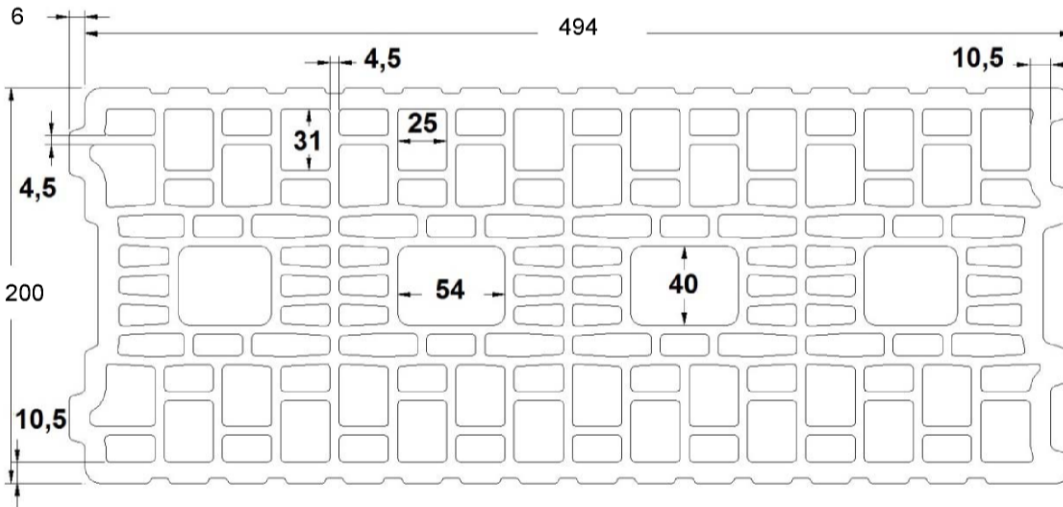

Table C50: Spacing and edge distances

Anchor size			All sizes
Edge distance	c_{cr}	[mm]	100 (120) ¹⁾
Minimum edge distance	c_{min} ²⁾	[mm]	100 (120) ¹⁾
Spacing	$s_{cr,II}$	[mm]	500
	$s_{cr,\perp}$	[mm]	299
Minimum spacing	s_{min}	[mm]	100

¹⁾ Value in brackets for VM-SH 20x85 and VM-SH 20x130

²⁾ For $V_{Rk,c}$: c_{min} according to ETAG 029, Annex C

Table C51: Group factor for anchor group in case of tension loading

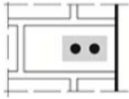
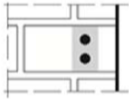
Configuration		with c [mm] \geq	with s [mm] \geq			
II: anchors placed parallel to horizontal joint		200	100	$\alpha_{g,N,II}$	[-]	2,0
		c_{cr}	500			2,0
⊥: anchors placed perpendicular to horizontal joint		200	100	$\alpha_{g,N,\perp}$		1,2
		c_{cr}	299			2,0

Injection System VMU plus for masonry

Annex C21

Performance - Clay hollow brick Porotherm Homebric

Description of the brick, Spacing and edge distances, Group factor

Brick type: Clay hollow brick Porotherm Homebric

Table C52: Group factor for anchor group in case of shear loading parallel to free edge

Configuration		with c [mm] ≥	with s [mm] ≥			
II: anchors placed parallel to horizontal joint		C_{cr}	500	$\alpha_{g,V,II}$	[-]	2,0
I: anchors placed perpendicular to horizontal joint		C_{cr}	299	$\alpha_{g,V,I}$		2,0

Table C53: Group factor for anchor group in case of shear load perpendicular to free edge

Configuration		with c [mm] ≥	with s [mm] ≥			
II: anchors placed parallel to horizontal joint		C_{cr}	500	$\alpha_{g,V,II}$	[-]	2,0
I: anchors placed perpendicular to horizontal joint		C_{cr}	299	$\alpha_{g,V,I}$		2,0

Table C54: Characteristic values of resistance under tension and shear loads

Anchor size	Sleeve	Effective Anchorage depth	Characteristic resistance			
			Use category			
			d/d w/d w/w			d/d w/d w/w
			40°C/24°C	80°C/50°C	120°C/72°C	All temperature ranges
h_{ef}	$N_{RK,b} = N_{RK,p}^{1)}$			$V_{RK,b}^{2)3)}$		
[mm]	[kN]			[kN]		
Compressive strength $f_b \geq 4 \text{ N/mm}^2$						
M8	12x80	80	0,9	0,9	0,75	2,0
M8 / M10 / IG-M6	16x85	85	0,9	0,9	0,75	2,0
	16x130	130	1,2	1,2	0,9	2,0
M12 / M16 / IG-M8 / IG-M10	20x85	85	0,9	0,9	0,75	2,5
	20x130	130	1,2	1,2	0,9	2,5
Compressive strength $f_b \geq 6 \text{ N/mm}^2$						
M8	12x80	80	0,9	0,9	0,9	2,5
M8 / M10 / IG-M6	16x85	85	0,9	0,9	0,9	2,5
	16x130	130	1,2	1,2	1,2	2,5
M12 / M16 / IG-M8 / IG-M10	20x85	85	0,9	0,9	0,9	3,0
	20x130	130	1,2	1,2	1,2	3,0

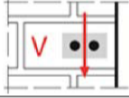
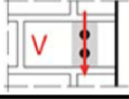
1) Values are valid for c_{cr} and c_{min}

2) Calculation of $V_{RK,c}$ see ETAG 029, Annex C, except for shear load parallel to free edge with $c \geq 200 \text{ mm}$: $V_{RK,c,II} = V_{RK,b}$

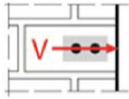
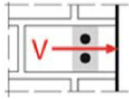
3) The values are valid for steel 5.6 or higher. For steel 4.6 and 4.8 multiply $V_{RK,b}$ by 0,8

Injection System VMU plus for masonry

Annex C22

Performance - Clay hollow brick Porotherm Homebric
Group factor, Characteristic values of resistance

Brick type: Clay hollow brick Porotherm Homebric

Table C55: Characteristic values of resistance under tension and shear loads (continue)

Anchor size	Sleeve	Effective Anchorage depth	Characteristic resistance			
			Use category			
			d/d w/d w/w			d/d w/d w/w
			40°C/24°C	80°C/50°C	120°C/72°C	All temperature ranges
h_{ef}	$N_{Rk,b} = N_{Rk,p}^{1)}$			$V_{Rk,b}^{2)3)}$		
[mm]	[kN]			[kN]		
Compressive strength $f_b \geq 10 \text{ N/mm}^2$						
M8	12x80	80	1,2	1,2	1,2	3,0
M8 / M10/ IG-M6	16x85	85	1,2	1,2	1,2	3,0
	16x130	130	1,5	1,5	1,5	3,5
M12 / M16 / IG-M8 / IG-M10	20x85	85	1,2	1,2	1,2	4,0
	20x130	130	1,5	1,5	1,5	4,0

1) Values are valid for c_{cr} and c_{min}

2) Calculation of $V_{Rk,c}$ see ETAG 029, Annex C, except for shear load parallel to free edge with $c \geq 200 \text{ mm}$: $V_{Rk,c,II} = V_{Rk,b}$

3) The values are valid for steel 5.6 or higher. For steel 4.6 and 4.8 multiply $V_{Rk,b}$ by 0,8

Table C56: Displacements

Anchor size	Sleeve	h_{ef}	N	δ_N / N	δ_{N0}	$\delta_{N\infty}$	V	δ_{V0}	$\delta_{V\infty}$
		[mm]	[kN]	[mm/kN]	[mm]	[mm]	[kN]	[mm]	[mm]
M8	12x80	80	0,34	0,80	0,27	0,55	0,9	1,20	1,80
M8 / M10/ IG-M6	16x85	85					0,9		
	16x130	130	0,43		0,34	0,69	1,0		
M12 / M16 / IG-M8 / IG-M10	20x85	85	0,34		0,27	0,55	1,14		
	20x130	130	0,43	0,34	0,69				

Injection System VMU plus for masonry

Performance - Clay hollow brick Porotherm Homebric
Characteristic values of resistance (continue), Displacements

Annex C23

Brick type: Clay hollow brick BGV Thermo

Table C57: Description of the brick

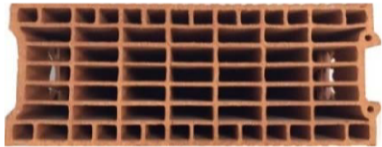
Brick type	Clay hollow brick BGV Thermo		
Bulk density	ρ [kg/dm ³]	0,6	
Compressive strength	$f_b \geq$ [N/mm ²]	4, 6 or 10	
Code	EN 771-1		
Producer (country code)	e.g. Leroux (FR)		
Brick dimensions	[mm]	500 x 200 x 314	
Drilling method	Rotary		

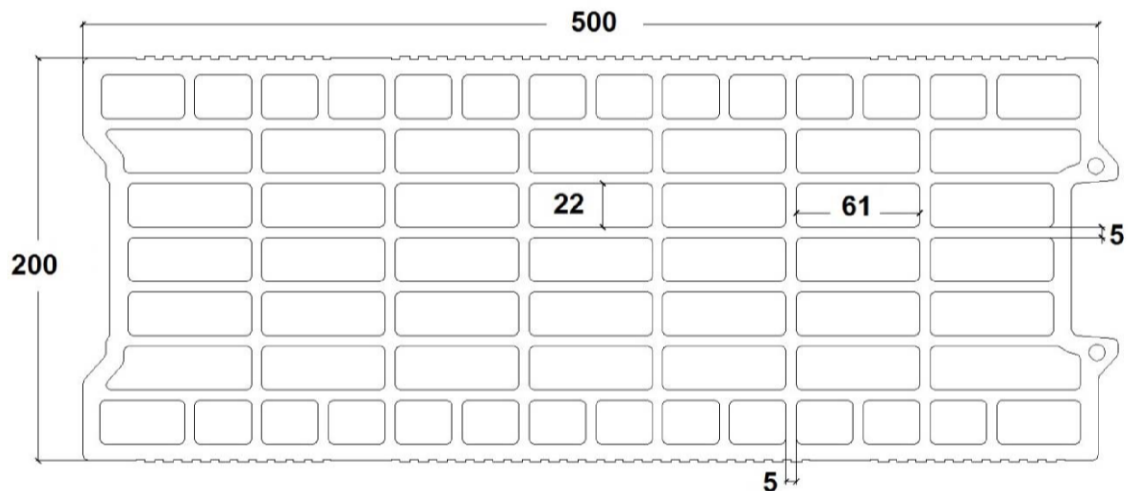

Table C58: Spacing and edge distances

Anchor size			All sizes
Edge distance	C_{cr}	[mm]	100 (120) ¹⁾
Minimum edge distance	C_{min} ²⁾	[mm]	100 (120) ¹⁾
Spacing	$S_{cr,II}$	[mm]	500
	$S_{cr,\perp}$	[mm]	314
Minimum spacing	S_{min}	[mm]	100

¹⁾ Values in brackets for VM-SH 20x85 and VM-SH 20x130

²⁾ For $V_{Rk,c}$: C_{min} according to ETAG 029, Annex C

Table C59: Group factor for anchor group in case of tension loading

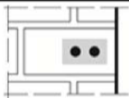
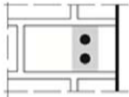
Configuration		with c [mm] \geq	with s [mm] \geq			
II: anchors placed parallel to horizontal joint		200	100	$\alpha_{g,N,II}$	[-]	1,7
		C_{cr}	500			2,0
⊥: anchors placed perpendicular to horizontal joint		200	100	$\alpha_{g,N,\perp}$	[-]	1,1
		C_{cr}	314			2,0

Injection System VMU plus for masonry

Performance - Clay hollow brick BGV Thermo

Description of the brick, Spacing and edge distances, Group factor

Annex C24

Brick type: Clay hollow brick BGV Thermo

Table C60: Group factor for anchor group in case of shear loading parallel to free edge

Configuration		with c [mm] \geq	with s [mm] \geq			
II: anchors placed parallel to horizontal joint		C_{cr}	500	$\alpha_{g,V,II}$	[-]	2,0
I: anchors placed perpendicular to horizontal joint		C_{cr}	314	$\alpha_{g,V,I}$		2,0

Table C61: Group factor for anchor group in case of shear load perpendicular to free edge

Configuration		with c [mm] \geq	with s [mm] \geq			
II: anchors placed parallel to horizontal joint		C_{cr}	500	$\alpha_{g,V,II}$	[-]	2,0
I: anchors placed perpendicular to horizontal joint		C_{cr}	314	$\alpha_{g,V,I}$		2,0

Injection System VMU plus for masonry

Performance - Clay hollow brick BGV Thermo
Group factor

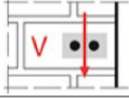
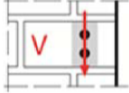
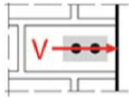
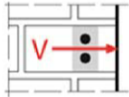
Annex C25

Brick type: Clay hollow brick BGV Thermo

Table C62: Characteristic values of resistance under tension and shear loads

Anchor size	Sleeve	Effective Anchorage depth	Characteristic resistance			
			Use category			
			d/d w/d w/w			d/d w/d w/w
			40°C/24°C	80°C/50°C	120°C/72°C	All temperature ranges
h_{ef} [mm]	$N_{Rk,b} = N_{Rk,p}^{1)}$ [kN]			$V_{Rk,b}^{2)3)}$ [kN]		
Compressive strength $f_b \geq 4 \text{ N/mm}^2$						
M8	12x80	80	0,6	0,6	0,6	2,0
M8 / M10/ IG-M6	16x85	85	0,6	0,6	0,6	2,0
	16x130	130	1,2	1,2	0,9	2,5
M12 / M16 / IG-M8 / IG-M10	20x85	85	0,6	0,6	0,6	2,5
	20x130	130	1,2	1,2	0,9	2,5
Compressive strength $f_b \geq 6 \text{ N/mm}^2$						
M8	12x80	80	0,9	0,9	0,75	2,5
M8 / M10/ IG-M6	16x85	85	0,9	0,9	0,75	2,5
	16x130	130	1,5	1,5	1,2	3,0
M12 / M16 / IG-M8 / IG-M10	20x85	85	0,9	0,9	0,75	3,0
	20x130	130	1,5	1,5	1,2	3,0
Compressive strength $f_b \geq 10 \text{ N/mm}^2$						
M8	12x80	80	0,9	0,9	0,9	3,5
M8 / M10/ IG-M6	16x85	85	0,9	0,9	0,9	3,5
	16x130	130	2,0	2,0	1,5	4,0
M12 / M16 / IG-M8 / IG-M10	20x85	85	0,9	0,9	0,9	4,0
	20x130	130	2,0	2,0	1,5	4,0

1) Values are valid for c_{cr} and c_{min}

2) Calculation of $V_{Rk,c}$ see ETAG 029, Annex C, except for shear load parallel to free edge with $c \geq 250 \text{ mm}$: $V_{Rk,c,II} = V_{Rk,b}$

3) The values are valid for steel 5.6 or higher. For steel 4.6 and 4.8 multiply $V_{Rk,b}$ by 0,8

Table C63: Displacements

Anchor size	Sleeve	h_{ef}	N	δ_N / N	δ_{N0}	$\delta_{N\infty}$	V	δ_{V0}	$\delta_{V\infty}$
		[mm]	[kN]	[mm/kN]	[mm]	[mm]	[kN]	[mm]	[mm]
M8	12x80	80	0,26	0,80	0,21	0,41	0,7	1,00	1,50
M8 / M10/ IG-M6	16x85	85			0,34	0,69			
	16x130	130	0,43		0,69				
M12 / M16 / IG-M8 / IG-M10	20x85	85	0,26		0,21	0,41	0,86		
	20x130	130	0,43	0,34	0,69				

Injection System VMU plus for masonry

Performance - Clay hollow brick BGV Thermo
Characteristic values of resistance, Displacements

Annex C26

Brick type: Clay hollow brick Calibric R+

Table C64: Description of the brick

Brick type	Clay hollow brick Calibric R+		
Bulk density	ρ [kg/dm ³]	0,6	
Compressive strength	$f_b \geq$ [N/mm ²]	6, 9 or 12	
Code	EN 771-1		
Producer (country code)	e.g. Terreal (FR)		
Brick dimensions	[mm]	500 x 200 x 314	
Drilling method	Rotary		

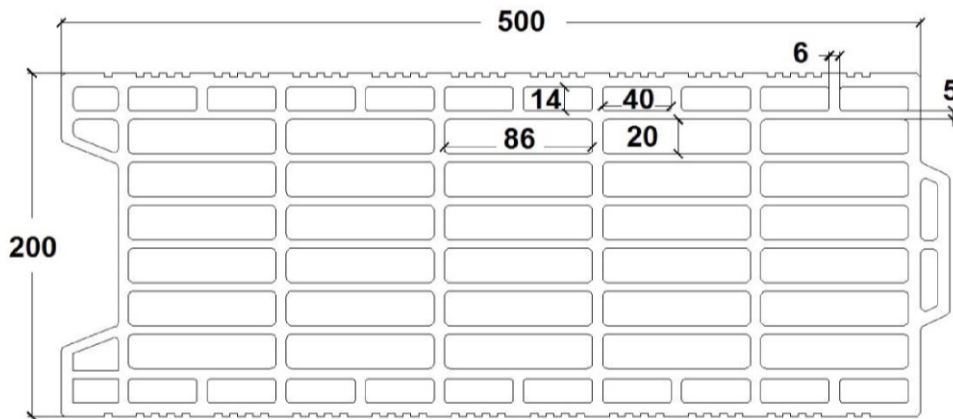

Table C65: Spacing and edge distances

Anchor size			All sizes
Edge distance	c_{cr}	[mm]	100 (120) ¹⁾
Minimum edge distance	c_{min} ²⁾	[mm]	100 (120) ¹⁾
Spacing	$s_{cr,II}$	[mm]	500
	$s_{cr,\perp}$	[mm]	314
Minimum spacing	s_{min}	[mm]	100

¹⁾ Value in brackets for VM-SH 20x85 and VM-SH 20x130

²⁾ For $V_{Rk,c}$: c_{min} according to ETAG 029, Annex C

Table C66: Group factor for anchor group in case of tension loading

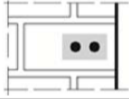
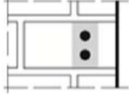
Configuration		with c [mm] \geq	with s [mm] \geq			
II: anchors placed parallel to horizontal joint		175	100	$\alpha_{g,N,II}$	[-]	1,7
		c_{cr}	500			2,0
⊥: anchors placed perpendicular to horizontal joint		175	100	$\alpha_{g,N,\perp}$		1,0
		c_{cr}	314			2,0

Injection System VMU plus for masonry

Annex C27

Performance - Clay hollow brick Calibric R+

Description of the brick, Spacing and edge distances, Group factor

Brick type: Clay hollow brick Calibric R+

Table C67: Group factor for anchor group in case of shear loading parallel to free edge

Configuration		with c [mm] \geq	with s [mm] \geq		
II: anchors placed parallel to horizontal joint		C_{cr}	500	$\alpha_{g,V,II}$	[-]
I: anchors placed perpendicular to horizontal joint		C_{cr}	314	$\alpha_{g,V,I}$	

Table C68: Group factor for anchor group in case of shear load perpendicular to free edge

Configuration		with c [mm] \geq	with s [mm] \geq		
II: anchors placed parallel to horizontal joint		C_{cr}	500	$\alpha_{g,V,II}$	[-]
I: anchors placed perpendicular to horizontal joint		C_{cr}	314	$\alpha_{g,V,I}$	

Table C69: Characteristic values of resistance under tension and shear loads

Anchor size	Sleeve	Effective Anchorage depth	Characteristic resistance			
			Use category			
			d/d		d/d	
			w/d	w/d	w/w	w/w
		40°C/24°C	80°C/50°C	120°C/72°C	All temperature ranges	
		h_{ef}	$N_{RK,b} = N_{RK,p}^{1)}$		$V_{RK,b}^{2)3)}$	
		[mm]	[kN]		[kN]	
Compressive strength $f_b \geq 6 \text{ N/mm}^2$						
M8	12x80	80	0,9	0,9	0,75	3,0
M8 / M10 / IG-M6	16x85	85	0,9	0,9	0,75	4,0
	16x130	130	1,2	1,2	0,9	4,0
M12 / M16 / IG-M8 / IG-M10	20x85	85	0,9	0,9	0,75	6,0
	20x130	130	1,2	1,2	0,9	6,0
Compressive strength $f_b \geq 9 \text{ N/mm}^2$						
M8	12x80	80	1,2	1,2	0,9	3,5
M8 / M10 / IG-M6	16x85	85	1,2	1,2	0,9	5,0
	16x130	130	1,5	1,5	1,2	5,0
M12 / M16 / IG-M8 / IG-M10	20x85	85	1,2	1,2	0,9	7,5
	20x130	130	1,5	1,5	1,2	7,5

1) Values are valid for c_{cr} and c_{min}

2) Calculation of $V_{RK,c}$ see ETAG 029, Annex C, except for shear load parallel to free edge with $c \geq 250 \text{ mm}$: $V_{RK,c,II} = V_{RK,b}$

3) The values are valid for steel 5.6 or higher. For steel 4.6 and 4.8 multiply $V_{RK,b}$ by 0,8

Injection System VMU plus for masonry

Annex C28

Performance - Clay hollow brick Calibric R+
Group factor, Characteristic values of resistance

Brick type: Clay hollow brick Calibric R+

Table C70: Characteristic values of resistance under tension and shear load (continue)

Anchor size	Sleeve	Effective Anchorage depth	Characteristic resistance			
			Use category			
			d/d w/d w/w			d/d w/d w/w
			40°C/24°C	80°C/50°C	120°C/72°C	All temperature ranges
h_{ef}	$N_{Rk,b} = N_{Rk,p}^{1)}$			$V_{Rk,b}^{2)3)}$		
[mm]	[kN]			[kN]		
Compressive strength $f_b \geq 12 \text{ N/mm}^2$						
M8	12x80	80	1,2	1,2	0,9	4,0
M8 / M10/ IG-M6	16x85	85	1,2	1,2	0,9	5,5
	16x130	130	1,5	1,5	1,2	5,5
M12 / M16 / IG-M8 / IG-M10	20x85	85	1,2	1,2	0,9	8,5
	20x130	130	1,5	1,5	1,2	8,5

- 1) Values are valid for c_{cr} and c_{min}
- 2) Calculation of $V_{Rk,c}$ see ETAG 029, Annex C, except for shear load parallel to free edge with $c \geq 250 \text{ mm}$: $V_{Rk,c,II} = V_{Rk,b}$
- 3) The values are valid for steel 5.6 or higher. For steel 4.6 and 4.8 multiply $V_{Rk,b}$ by 0,8

Table C71: Displacements

Anchor size	Sleeve	h_{ef}	N	δ_N / N	δ_{N0}	$\delta_{N\infty}$	V	δ_{V0}	$\delta_{V\infty}$
		[mm]	[kN]	[mm/kN]	[mm]	[mm]	[kN]	[mm]	[mm]
M8	12x80	80	0,34	0,80	0,27	0,55	1,0	1,10	1,65
M8 / M10/ IG-M6	16x85	85					1,43		
	16x130	130	0,43		0,34	0,69			
M12 / M16 / IG-M8 / IG-M10	20x85	85	0,34		0,27	0,55	2,14	2,0	3,0
	20x130	130	0,43		0,34	0,69			

Injection System VMU plus for masonry

Performance - Clay hollow brick Calibric R+
Characteristic values of resistance, Displacements

Annex C29

Brick type: Clay hollow brick Urbanbric

Table C72: Description of the brick

Brick type	Clay hollow brick Urbanbric		
Bulk density	ρ [kg/dm ³]	0,7	
Compressive strength	$f_b \geq$ [N/mm ²]	6, 9 or 12	
Code	EN 771-1		
Producer (country code)	e.g. Imerys (FR)		
Brick dimensions	[mm]	560 x 200 x 274	
Drilling method	Rotary		

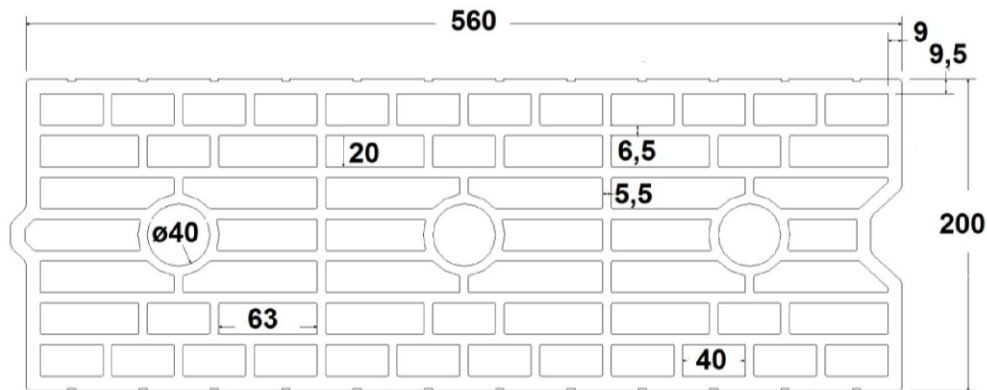

Table C73: Spacing and edge distances

Anchor size			All sizes
Edge distance	C_{cr}	[mm]	100 (120) ¹⁾
Minimum edge distance	C_{min} ²⁾	[mm]	100 (120) ¹⁾
Spacing	$S_{cr,II}$	[mm]	560
	$S_{cr,\perp}$	[mm]	274
Minimum spacing	S_{min}	[mm]	100

¹⁾ Value in brackets for VM-SH 20x85 and VM-SH 20x130

²⁾ For $V_{Rk,c}$: C_{min} according to ETAG 029, Annex C

Table C74: Group factor for anchor group in case of tension loading

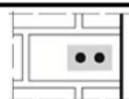
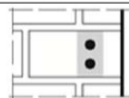
Configuration		with c [mm] \geq	with s [mm] \geq			
II: anchors placed parallel to horizontal joint		185	100	$\alpha_{g,N,II}$	[-]	1,9
		C_{cr}	560			2,0
⊥: anchors placed perpendicular to horizontal joint		185	100	$\alpha_{g,N,\perp}$	[-]	1,1
		C_{cr}	274			2,0

Injection System VMU plus for masonry

Performance - Clay hollow brick Urbanbric

Description of the brick, Spacing and edge distances, Group factor

Annex C30

Brick type: Clay hollow brick Urbanbric

Table C75: Group factor for anchor group in case of shear loading parallel to free edge

Configuration		with c [mm] ≥	with s [mm] ≥			
II: anchors placed parallel to horizontal joint		C_{cr}	560	$\alpha_{g,V,II}$	[-]	2,0
I: anchors placed perpendicular to horizontal joint		C_{cr}	274	$\alpha_{g,V,I}$		2,0

Table C76: Group factor for anchor groups in case of shear load perpendicular to free edge

Configuration		with c [mm] ≥	with s [mm] ≥			
II: anchors placed parallel to horizontal joint		C_{cr}	560	$\alpha_{g,V,II}$	[-]	2,0
I: anchors placed perpendicular to horizontal joint		C_{cr}	274	$\alpha_{g,V,I}$		2,0

Table C77: Characteristic values of resistance under tension and shear load

Anchor size	Sleeve	Effective Anchorage depth	Characteristic resistance			
			Use category			
			d/d w/d w/w			d/d w/d w/w
			40°C/24°C	80°C/50°C	120°C/72°C	All temperature ranges
h_{ef}	$N_{RK,b} = N_{RK,p}^{1)}$			$V_{RK,b}^{2)3)}$		
[mm]	[kN]			[kN]		
Compressive strength $f_b \geq 6 \text{ N/mm}^2$						
M8	12x80	80	0,9	0,9	0,75	3,0
M8 / M10/ IG-M6	16x85	85	0,9	0,9	0,75	3,0
	16x130	130	2,0	2,0	1,5	3,0
M12 / M16 / IG-M8 / IG-M10	20x85	85	0,9	0,9	0,75	3,5
	20x130	130	2,0	2,0	1,5	3,5
Compressive strength $f_b \geq 9 \text{ N/mm}^2$						
M8	12x80	80	0,9	0,9	0,9	4,0
M8 / M10/ IG-M6	16x85	85	0,9	0,9	0,9	4,0
	16x130	130	2,5	2,5	2,0	4,0
M12 / M16 / IG-M8 / IG-M10	20x85	85	0,9	0,9	0,9	4,5
	20x130	130	2,5	2,5	2,0	4,5

1) Values are valid for c_{cr} and c_{min}

2) Calculation of $V_{RK,c}$ see ETAG 029, Annex C, except for shear load parallel to free edge with $c \geq 190 \text{ mm}$: $V_{RK,c,II} = V_{RK,b}$

3) The values are valid for steel 5.6 or higher. For steel 4.6 and 4.8 multiply $V_{RK,b}$ by 0,8

Injection System VMU plus for masonry

Annex C31

Performance - Clay hollow brick Urbanbric
Group factor, Characteristic values of resistance

Brick type: Clay hollow brick Urbanbric

Table C78: Characteristic values of resistance under tension and shear load (continue)

Anchor size	Sleeve	Effective Anchorage depth	Characteristic resistance			
			Use category			
			d/d w/d w/w			d/d w/d w/w
			40°C/24°C	80°C/50°C	120°C/72°C	All temperature ranges
h_{ef}	$N_{Rk,b} = N_{Rk,p}^{1)}$			$V_{Rk,b}^{2)3)}$		
[mm]	[kN]			[kN]		
Compressive strength $f_b \geq 12 \text{ N/mm}^2$						
M8	12x80	80	1,2	1,2	0,9	4,5
M8 / M10/ IG-M6	16x85	85	1,2	1,2	0,9	4,5
	16x130	130	3,0	3,0	2,5	4,5
M12 / M16 / IG-M8 / IG-M10	20x85	85	1,2	1,2	0,9	5,0
	20x130	130	3,0	3,0	2,5	5,0

1) Values are valid for c_{cr} and c_{min}

2) Calculation of $V_{Rk,c}$ see ETAG 029, Annex C, except for shear load parallel to free edge with $c \geq 190 \text{ mm}$: $V_{Rk,c,II} = V_{Rk,b}$

3) The values are valid for steel 5.6 or higher. For steel 4.6 and 4.8 multiply $V_{Rk,b}$ by 0,8

Table C79: Displacements

Anchor size	Sleeve	h_{ef}	N	δ_N / N	δ_{N0}	$\delta_{N\infty}$	V	δ_{V0}	$\delta_{V\infty}$
		[mm]	[kN]	[mm/kN]	[mm]	[mm]	[kN]	[mm]	[mm]
M8	12x80	80	0,34	0,80	0,27	0,55	1,30	1,00	1,50
M8 / M10/ IG-M6	16x85	85			0,69	1,37			
	16x130	130	0,27		0,55				
M12 / M16 / IG-M8 / IG-M10	20x85	85	0,34		0,69	1,37	1,43		
	20x130	130	0,86						

Injection System VMU plus for masonry

Performance - Clay hollow brick Urbanbric
Characteristic values of resistance, Displacements

Annex C32

Brick type: Clay hollow brick Brique creuse C40

Table C80: Description of the brick

Brick type	Clay hollow brick Brique creuse C40		
Bulk density	ρ [kg/dm ³]	0,7	
Compressive strength	$f_b \geq$ [N/mm ²]	4, 8 or 12	
Code	EN 771-1		
Producer (country code)	e.g. Terreal (FR)		
Brick dimensions	[mm]	500 x 200 x 200	
Drilling method	Rotary		

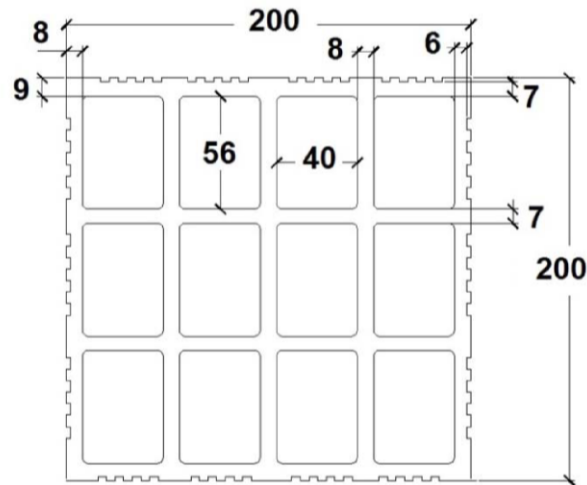

Table C81: Spacing and edge distances

Anchor size			All sizes
Edge distance	c_{cr}	[mm]	100 (120) ¹⁾
Minimum edge distance	c_{min} ²⁾	[mm]	100 (120) ¹⁾
Spacing	$s_{cr,II}$	[mm]	500
	$s_{cr,\perp}$	[mm]	200
Minimum spacing	s_{min}	[mm]	200

¹⁾ Values in brackets for VM-SH 20x85 and VM-SH 20x130

²⁾ For $V_{Rk,c}$: c_{min} according to ETAG 029, Annex C

Table C82: Group factor for anchor group in case of tension loading

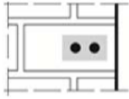
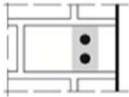
Configuration		with c [mm] \geq	with s [mm] \geq			
II: anchors placed parallel to horizontal joint		c_{cr}	200	$\alpha_{g,N,II}$	[-]	2,0
I: anchors placed perpendicular to horizontal joint		c_{cr}	200	$\alpha_{g,N,\perp}$		2,0

Injection System VMU plus for masonry

Performance - Clay hollow brick Brique creuse C40

Description of the brick, Spacing and edge distances, Group factor

Annex C33

Brick type: Clay hollow brick Brique creuse C40

Table C83: Group factor for anchor group in case of shear loading parallel to free edge

Configuration		with c [mm] ≥	with s [mm] ≥			
II: anchors placed parallel to horizontal joint		C_{cr}	500	$\alpha_{g,V,II}$	[-]	2,0
I: anchors placed perpendicular to horizontal joint		C_{cr}	200	$\alpha_{g,V,I}$		2,0

Table C84: Group factor for anchor group in case of shear load perpendicular to free edge

Configuration		with c [mm] ≥	with s [mm] ≥			
II: anchors placed parallel to horizontal joint		C_{cr}	500	$\alpha_{g,V,II}$	[-]	2,0
I: anchors placed perpendicular to horizontal joint		C_{cr}	200	$\alpha_{g,V,I}$		2,0

Table C85: Characteristic values of resistance under tension and shear load

Anchor size	Sleeve	Effective Anchorage depth	Characteristic resistance			
			Use category			
			d/d w/d w/w			d/d w/d w/w
			40°C/24°C	80°C/50°C	120°C/72°C	All temperature ranges
h_{ef}	$N_{RK,b} = N_{RK,p}^{1)}$			$V_{RK,b}^{2)3)}$		
[mm]	[kN]			[kN]		
Compressive strength $f_b \geq 4 \text{ N/mm}^2$						
M8	12x80	80	0,6	0,6	0,6	0,9
M8 / M10/ IG-M6	16x85	85				
	16x130	130				
M12 / M16 / IG-M8 / IG-M10	20x85	85				
	20x130	130				
Compressive strength $f_b \geq 8 \text{ N/mm}^2$						
M8	12x80	80	0,9	0,9	0,75	1,2
M8 / M10/ IG-M6	16x85	85				
	16x130	130				
M12 / M16 / IG-M8 / IG-M10	20x85	85				
	20x130	130				

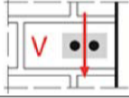
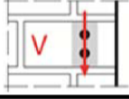
1) Values are valid for c_{cr} and c_{min}

2) Calculation of $V_{RK,c}$ see ETAG 029, Annex C

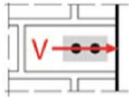
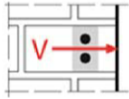
3) The values are valid for steel 5.6 or higher. For steel 4.6 and 4.8 multiply $V_{RK,b}$ by 0,8

Injection System VMU plus for masonry

Annex C34

Performance - Clay hollow brick Brique creuse C40

Group factor, Characteristic values of resistance

Brick type: Clay hollow brick Brique creuse C40

Table C86: Characteristic values of resistance under tension and shear load (continue)

Anchor size	Sleeve	Effective Anchorage depth	Characteristic resistance			
			Use category			
			d/d w/d w/w			d/d w/d w/w
			40°C/24°C	80°C/50°C	120°C/72°C	All temperature ranges
h_{ef}	$N_{Rk,b} = N_{Rk,p}^{1)}$			$V_{Rk,b}^{2)3)}$		
[mm]	[kN]			[kN]		
Compressive strength $f_b \geq 12 \text{ N/mm}^2$						
M8	12x80	80	1,2	1,2	0,9	1,5
M8 / M10/ IG-M6	16x85	85				
	16x130	130				
M12 / M16 / IG-M8 / IG-M10	20x85	85				
	20x130	130				

- 1) Values are valid for c_{cr} and c_{min}
- 2) Calculation of $V_{Rk,c}$ see ETAG 029, Annex C
- 3) The values are valid for steel 5.6 or higher. For steel 4.6 and 4.8 multiply $V_{Rk,b}$ by 0,8

Table C87: Displacements

Anchor size	Sleeve	h_{ef}	N	δ_N / N	δ_{N0}	$\delta_{N\infty}$	V	δ_{V0}	$\delta_{V\infty}$
		[mm]	[kN]	[mm/kN]	[mm]	[mm]	[kN]	[mm]	[mm]
M8	12x80	80	0,17	0,80	0,14	0,27	0,3	0,9	1,35
M8 / M10/ IG-M6	16x85	85							
	16x130	130	0,14		0,11	0,23			
M12 / M16 / IG-M8 / IG-M10	20x85	85	0,17		0,14	0,27			
	20x130	130	0,14	0,11	0,23				

Injection System VMU plus for masonry

Performance - Clay hollow brick Brique creuse C40
Characteristic values of resistance, Displacements

Annex C35

Brick type: Clay hollow brick Blocchi Leggeri

Table C88: Description of the brick

Brick type	Clay hollow brick Blocchi Leggeri		
Bulk density	ρ [kg/dm ³]	0,6	
Compressive strength	$f_b \geq$ [N/mm ²]	4, 6, 8 or 12	
Code	EN 771-1		
Producer (country code)	e.g. Wienerberger (IT)		
Brick dimensions	[mm]	250 x 120 x 250	
Drilling method	Rotary		

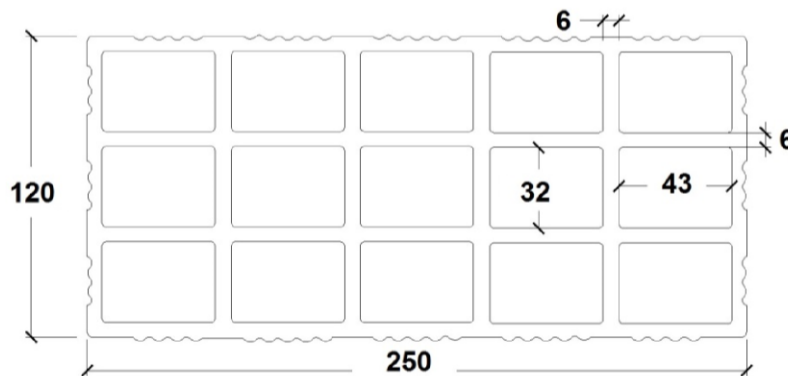
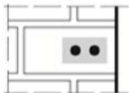
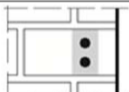

Table C89: Spacing and edge distances

Anchor size			All sizes
Edge distance	c_{cr}	[mm]	100 (120) ¹⁾
Minimum edge distance	c_{min}	[mm]	60
Spacing	$s_{cr,II}$	[mm]	250
	$s_{cr,I}$	[mm]	120
Minimum spacing	s_{min}	[mm]	100

¹⁾ Value in brackets for VM-SH 20x85; VM-SH 20x130 and VM-SH 20x200

Table C90: Group factor for anchor group in case of tension loading

Configuration		with c [mm] \geq	with s [mm] \geq			
II: anchors placed parallel to horizontal joint		60	100	$\alpha_{g,N,II}$	[-]	1,0
		c_{cr}	250			2,0
I: anchors placed perpendicular to horizontal joint		60	100	$\alpha_{g,N,I}$		2,0

Injection System VMU plus for masonry

Annex C36

Performance - Clay hollow brick Blocchi Leggeri

Description of the brick, Spacing and edge distances, Group factor

Brick type: Clay hollow brick Blocchi Leggeri

Table C91: Group factor for anchor group in case of shear loading parallel to free edge

Configuration		with c [mm] ≥	with s [mm] ≥			
II: anchors placed parallel to horizontal joint		60 ¹⁾	100 ¹⁾	$\alpha_{g,V,II}$	[-]	1,0
		c_{cr}	250			2,0
I: anchors placed perpendicular to horizontal joint		60 ¹⁾	100 ¹⁾	$\alpha_{g,V,I}$		1,6
		c_{cr}	250			2,0

¹⁾ Only valid for $V_{Rk,b}$ according to Table C93 and C94 values in brackets

Table C92: Group factor for anchor group in case of shear load perpendicular to free edge

Configuration		with c [mm] ≥	with s [mm] ≥			
II: anchors placed parallel to horizontal joint		60 ¹⁾	100 ¹⁾	$\alpha_{g,V,II}$	[-]	1,0
		c_{cr}	250			2,0
I: anchors placed perpendicular to horizontal joint		60 ¹⁾	100 ¹⁾	$\alpha_{g,V,I}$		1,6
		c_{cr}	250			2,0

¹⁾ Only valid for $V_{Rk,b}$ according to Table C93 and C94 values in brackets

Table C93: Characteristic values of resistance under tension and shear load

Anchor size	Sleeve	Effective Anchorage depth	Characteristic resistance			
			Use category			
			d/d w/d w/w			d/d w/d w/w
			40°C/24°C	80°C/50°C	120°C/72°C	All temperature ranges
		h_{ef}	$N_{Rk,b} = N_{Rk,p}$ ¹⁾			$V_{Rk,b}$ ⁴⁾
		[mm]	[kN]			[kN]
Compressive strength $f_b \geq 4 \text{ N/mm}^2$						
M8	12x80	80	0,4	0,4	0,3	2,0 ²⁾ (0,9) ³⁾
M8 / M10/ IG-M6	16x85	85				
	16x130	130				
M12 / M16 / IG-M8 / IG-M10	20x85	85				
	20x130	130				
	20x200	200				

1) Values are valid for c_{cr} and c_{min}

2) Calculation of $V_{Rk,c}$ see ETAG 029, Annex C, except for shear load parallel to free edge with $c \geq 125 \text{ mm}$: $V_{Rk,c,II} = V_{Rk,b}$

3) Values in brackets $V_{Rk,c} = V_{Rk,b}$ for anchors with c_{min}

4) The values are valid for steel 5.6 or higher. For steel 4.6 and 4.8 multiply $V_{Rk,b}$ by 0,8

Injection System VMU plus for masonry

Annex C37

Performance - Clay hollow brick Blocchi Leggeri
Group factor, Characteristic values of resistance

Brick type: Clay hollow brick Blocchi Leggeri

Table C94: Characteristic values of resistance under tension and shear load (continue)

Anchor size	Sleeve	Effective Anchorage depth	Characteristic resistance			
			Use category			
			d/d w/d w/w			d/d w/d w/w
			40°C/24°C	80°C/50°C	120°C/72°C	All temperature ranges
h_{ef}	$N_{RK,b} = N_{RK,p}^{1)}$			$V_{RK,b}^{4)}$		
[mm]	[kN]			[kN]		
Compressive strength $f_b \geq 6 \text{ N/mm}^2$						
M8	12x80	80	0,5	0,5	0,4	2,5 ²⁾ (1,2) ³⁾
M8 / M10/ IG-M6	16x85	85				
	16x130	130				
M12 / M16 / IG-M8 / IG-M10	20x85	85				
	20x130	130				
	20x200	200				
Compressive strength $f_b \geq 8 \text{ N/mm}^2$						
M8	12x80	80	0,6	0,6	0,5	3,0 ²⁾ (1,2) ³⁾
M8 / M10/ IG-M6	16x85	85				
	16x130	130				
M12 / M16 / IG-M8 / IG-M10	20x85	85				
	20x130	130				
	20x200	200				
Compressive strength $f_b \geq 12 \text{ N/mm}^2$						
M8	12x80	80	0,6	0,6	0,6	3,5 ²⁾ (1,5) ³⁾
M8 / M10/ IG-M6	16x85	85				
	16x130	130				
M12 / M16 / IG-M8 / IG-M10	20x85	85				
	20x130	130				
	20x200	200				

- 1) Values are valid for c_{cr} and c_{min}
- 2) Calculation of $V_{RK,c}$ see ETAG 029, Annex C, except for shear load parallel to free edge with $c \geq 125 \text{ mm}$: $V_{RK,c,II} = V_{RK,b}$
- 3) Values in brackets $V_{RK,c} = V_{RK,b}$ for anchors with c_{min}
- 4) The values are valid for steel 5.6 or higher. For steel 4.6 and 4.8 multiply $V_{RK,b}$ by 0,8

Table C95: Displacements

Anchor size	Sleeve	h_{ef}	N	δ_N / N	δ_{N0}	$\delta_{N\infty}$	V	δ_{V0}	$\delta_{V\infty}$
		[mm]	[kN]	[mm/kN]	[mm]	[mm]	[kN]	[mm]	[mm]
All sizes	All sizes	All sizes	0,17	1,20	0,21	0,41	0,9	1,20	1,80

Injection System VMU plus for masonry

Performance - Clay hollow brick Blocchi Leggeri
Characteristic values of resistance, Displacements

Annex C38

Brick type: Clay hollow brick Doppio Uni

Table C96: Description of the brick

Brick type	Clay hollow brick Doppio Uni		
Bulk density ρ [kg/dm ³]	0,9		
Compressive strength $f_b \geq$ [N/mm ²]	10, 16, 20 or 28		
Code	EN 771-1		
Producer (country code)	e.g. Wienerberger (IT)		
Brick dimensions [mm]	250 x 120 x 120		
Drilling method	Rotary		
			

Table C97: Spacing and edge distances

Anchor size		All sizes	
Edge distance	C_{cr} [mm]	100 (120) ¹⁾	
Minimum edge distance	C_{min} ²⁾ [mm]	60	
Spacing	$S_{cr,II}$ [mm]	250	
	$S_{cr,L}$ [mm]	120	
Minimum spacing	$S_{min,II}$ [mm]	100	
	$S_{min,L}$ [mm]	120	

¹⁾ Value in brackets for VM-SH 20x85; VM-SH 20x130 and VM-SH 20x200

²⁾ For $V_{Rk,c}$: C_{min} according to ETAG 029, Annex C

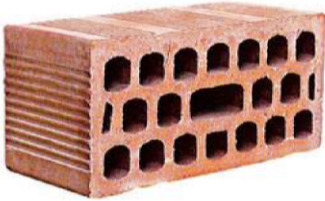
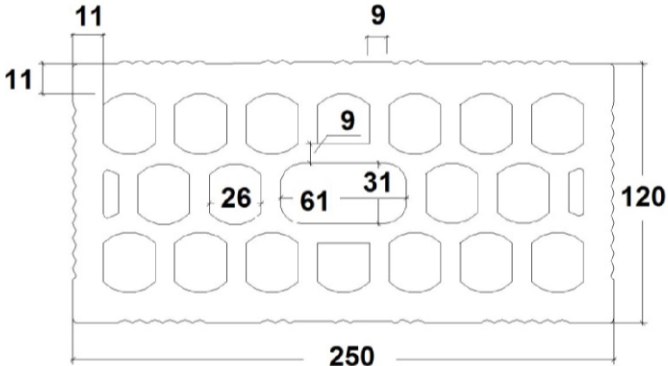
Table C98: Group factor for anchor group in case of tension loading

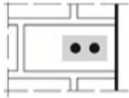
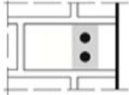
Configuration		with c [mm] \geq	with s [mm] \geq			
II: anchors placed parallel to horizontal joint		60	100	$\alpha_{g,N,II}$	[-]	1,0
		C_{cr}	250			2,0
I: anchors placed perpendicular to horizontal joint		60	100	$\alpha_{g,N,I}$		2,0

Injection System VMU plus for masonry

Annex C39

Performance - Clay hollow brick Doppio Uni

Description of the brick, Spacing and edge distances, Group factor

Brick type: Clay hollow brick Doppio Uni

Table C99: Group factor for anchor group in case of shear loading parallel to free edge

Configuration		with c [mm] \geq	with s [mm] \geq			
II: anchors placed parallel to horizontal joint		C_{cr}	250	$\alpha_{g,V,II}$	[-]	2,0
I: anchors placed perpendicular to horizontal joint		C_{cr}	120	$\alpha_{g,V,I}$		2,0

Table C100: Group factor for anchor group in case of shear load perpendicular to free edge

Configuration		with c [mm] \geq	with s [mm] \geq			
II: anchors placed parallel to horizontal joint		C_{cr}	250	$\alpha_{g,V,II}$	[-]	2,0
I: anchors placed perpendicular to horizontal joint		C_{cr}	120	$\alpha_{g,V,I}$		2,0

Table C101: Characteristic values of resistance under tension and shear load

Anchor size	Sleeve	Effective Anchorage depth	Characteristic resistance			
			Use category			
			d/d w/d w/w			d/d w/d w/w
			40°C/24°C	80°C/50°C	120°C/72°C	All temperature ranges
		h_{ef}	$N_{RK,b} = N_{RK,p}^{1)}$			$V_{RK,b}^{2)3)}$
		[mm]	[kN]			[kN]
Compressive strength $f_b \geq 10 \text{ N/mm}^2$						
M8	12x80	80	0,6	0,6	0,5	1,5
M8 / M10/ IG-M6	16x85	85				
	16x130	130				
M12 / M16 / IG-M8 / IG-M10	20x85	85				
	20x130	130				
	20x200	200				

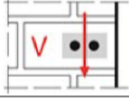
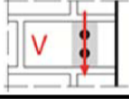
1) Values are valid for c_{cr} and c_{min}

2) Calculation of $V_{RK,c}$ see ETAG 029, Annex C

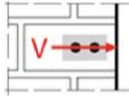
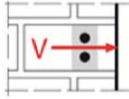
3) The values are valid for steel 5.6 or higher. For steel 4.6 and 4.8 multiply $V_{RK,b}$ by 0,8

Injection System VMU plus for masonry

Annex C40

Performance - Clay hollow brick Doppio Uni
Group factor, Characteristic values of resistance

Brick type: Clay hollow brick Doppio Uni

Table C102: Characteristic values of resistance under tension and shear load (continue)

Anchor size	Sleeve	Effective Anchorage depth	Characteristic resistance			
			Use category			
			d/d w/d w/w			d/d w/d w/w
			40°C/24°C	80°C/50°C	120°C/72°C	All temperature ranges
h_{ef}	$N_{Rk,b} = N_{Rk,p}^{1)}$			$V_{Rk,b}^{2)3)}$		
[mm]	[kN]			[kN]		
Compressive strength $f_b \geq 16 \text{ N/mm}^2$						
M8	12x80	80	0,75	0,75	0,6	2,0
M8 / M10/ IG-M6	16x85	85				
	16x130	130				
M12 / M16 / IG-M8 / IG-M10	20x85	85				
	20x130	130				
	20x200	200				
Compressive strength $f_b \geq 20 \text{ N/mm}^2$						
M8	12x80	80	0,9	0,9	0,75	2,0
M8 / M10/ IG-M6	16x85	85				
	16x130	130				
M12 / M16 / IG-M8 / IG-M10	20x85	85				
	20x130	130				
	20x200	200				
Compressive strength $f_b \geq 28 \text{ N/mm}^2$						
M8	12x80	80	1,2	1,2	0,9	2,5
M8 / M10/ IG-M6	16x85	85				
	16x130	130				
M12 / M16 / IG-M8 / IG-M10	20x85	85				
	20x130	130				
	20x200	200				

1) Values are valid for c_{cr} and c_{min}

2) Calculation of $V_{Rk,c}$ see ETAG 029, Annex C

3) The values are valid for steel 5.6 or higher. For steel 4.6 and 4.8 multiply $V_{Rk,b}$ by 0,8

Table C103: Displacements

Anchor size	Sleeve	h_{ef}	N	δ_N / N	δ_{N0}	$\delta_{N\infty}$	V	δ_{v0}	$\delta_{v\infty}$
		[mm]	[kN]	[mm/kN]	[mm]	[mm]	[kN]	[mm]	[mm]
All sizes	All sizes	All sizes	0,26	1,20	0,31	0,62	0,6	0,3	0,45

Injection System VMU plus for masonry

Performance - Clay hollow brick Doppio Uni
Characteristic values of resistance, Displacements

Annex C41

Brick type: Hollow lightweight concrete Bloc creux B40

Table C104: Description of the brick

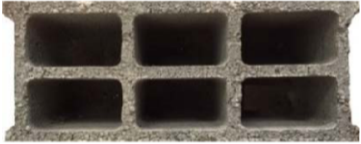
Brick type	Hollow Lightweight concrete Bloc creux B40		
Bulk density	ρ [kg/dm ³]	0,8	
Compressive strength	$f_b \geq$ [N/mm ²]	4	
Code	EN 771-3		
Producer (country code)	e.g. Sepa (FR)		
Brick dimensions	[mm]	494 x 200 x 190	
Drilling method	Rotary		

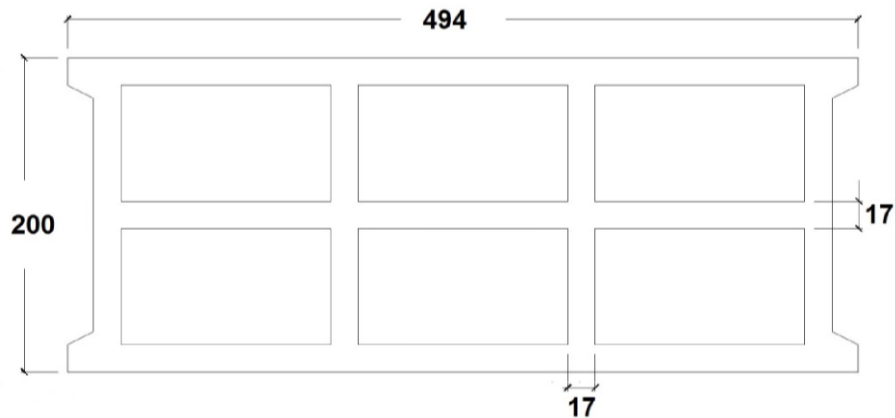

Table C105: Spacing and edge distances

Anchor size			All sizes
Edge distance	C_{cr}	[mm]	100 (120) ¹⁾
Minimum edge distance	C_{min} ²⁾	[mm]	100 (120) ¹⁾
Spacing	$S_{cr,II}$	[mm]	494
	$S_{cr,\perp}$	[mm]	190
Minimum spacing	S_{min}	[mm]	100

¹⁾ Value in brackets for VM-SH 20x85 and VM-SH 20x130

²⁾ For $V_{Rk,c}$: C_{min} according to ETAG 029, Annex C

Table C106: Group factor for anchor group in case of tension loading

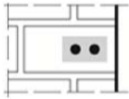
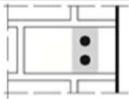
Configuration		with c [mm] \geq	with s [mm] \geq			
II: anchors placed parallel to horizontal joint		100	100	$\alpha_{g,N,II}$	[-]	1,5
		C_{cr}	494			2,0
⊥: anchors placed perpendicular to horizontal joint		100	100	$\alpha_{g,N,\perp}$		1,0
		C_{cr}	190			2,0

Injection System VMU plus for masonry

Performance - Hollow Lightweight concrete Bloc creux B40

Description of the brick, Spacing and edge distances, Group factor

Annex C42

Brick type: Hollow lightweight concrete Bloc creux B40

Table C107: Group factor for anchor group in case of shear loading parallel to free edge

Configuration		with c [mm] ≥	with s [mm] ≥			
II: anchors placed parallel to horizontal joint		50	100	$\alpha_{g,V,II}$	[-]	1,1
		c_{cr}	494			2,0
I: anchors placed perpendicular to horizontal joint		100	100	$\alpha_{g,V,I}$		1,1
		c_{cr}	190			2,0

Table C108: Group factor for anchor group in case of shear load perpendicular to free edge

Configuration		with c [mm] ≥	with s [mm] ≥			
II: anchors placed parallel to horizontal joint		c_{cr}	494	$\alpha_{g,V,II}$	[-]	2,0
		c_{cr}	190			$\alpha_{g,V,I}$

Table C109: Characteristic values of resistance under tension and shear load

Anchor size	Sleeve	Effective anchorage depth	Characteristic resistance						
			Use category						
			d/d			w/d			d/d
			40°C/24°C	80°C/50°C	120°C/72°C	40°C/24°C	80°C/50°C	120°C/72°C	w/d
							All temperature ranges		
		h_{ef}	$N_{Rk,b} = N_{Rk,p}^{1)}$			$N_{Rk,b} = N_{Rk,p}^{1)}$			$V_{Rk,b}^{2)3)}$
		[mm]	[kN]						
Compressive strength $f_b \geq 4 \text{ N/mm}^2$									
M8	12x80	80	1,2	0,9	0,75	0,9	0,75	3,0	
M8 / M10/ IG-M6	16x85	85							0,9
	16x130	130							1,2
M12 / M16 / IG-M8 / IG-M10	20x85	85							1,2
	20x130	130	1,2						

- 1) Values are valid for c_{cr} and c_{min}
- 2) Calculation of $V_{Rk,c}$ see ETAG 029, Annex C, except for shear load parallel to free edge with $c \geq 250 \text{ mm}$: $V_{Rk,c,II} = V_{Rk,b}$
- 3) The values are valid for steel 5.6 or higher. For steel 4.6 and 4.8 multiply $V_{Rk,b}$ by 0,8

Table C110: Displacements

Anchor size	Sleeve	h_{ef}	N	δ_N / N	δ_{N0}	$\delta_{N\infty}$	V	δ_{V0}	$\delta_{V\infty}$
		[mm]	[kN]	[mm/kN]	[mm]	[mm]	[kN]	[mm]	[mm]
All sizes	All sizes	All sizes	0,34	0,90	0,31	0,62	0,86	0,9	1,35

Injection System VMU plus for masonry

Annex C43

Performance - Hollow lightweight concrete Bloc creux B40

Group factor, Characteristic values of resistance, Displacements

Brick type: Solid lightweight concrete - LAC

Table C111: Description of the brick

Brick type	Solid lightweight concrete LAC		
Bulk density	ρ [kg/dm ³]	0,6	
Compressive strength	$f_b \geq$ [N/mm ²]	2	
Code	EN 771-3		
Producer (country code)	e.g. Bisotherm (DE)		
Brick dimensions	[mm]	300 x 123 x 248	
Drilling method	Rotary		

Table C112: Spacing and edge distances

Anchor size			All sizes
Edge distance	C_{cr}	[mm]	$1,5 \cdot h_{ef}$
Minimum edge distance	C_{min}	[mm]	60
Spacing	S_{cr}	[mm]	$3 \cdot h_{ef}$
Minimum spacing	S_{min}	[mm]	120

Table C113: Group factor for anchor group in case of tension loading

Configuration		with c [mm] \geq	with s [mm] \geq	$\alpha_{g,N,II}$	[-]	
II: anchors placed parallel to horizontal joint		90	120			
		$1,5 \cdot h_{ef}$	$3 \cdot h_{ef}$	2,0		
⊥: anchors placed perpendicular to horizontal joint		124	120	$\alpha_{g,N,\perp}$		1,1
		$1,5 \cdot h_{ef}$	$3 \cdot h_{ef}$			2,0

Table C114: Group factor for anchor group in case of shear loading parallel to free edge



Configuration		with c [mm] \geq	with s [mm] \geq	$\alpha_{g,V,II}$	[-]	
II: anchors placed parallel to horizontal joint		60	120			
		90	120	2,0		
⊥: anchors placed perpendicular to horizontal joint		60	120	$\alpha_{g,V,\perp}$		0,6
		124	120			2,0

Table C115: Group factor for anchor group in case of shear load perpendicular to free edge

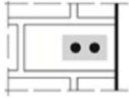
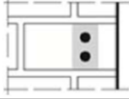
Configuration		with c [mm] \geq	with s [mm] \geq	$\alpha_{g,V,II}$	[-]	
II: anchors placed parallel to horizontal joint		60	120			
		90	120	2,0		
⊥: anchors placed perpendicular to horizontal joint		60	120	$\alpha_{g,V,\perp}$		0,6
		$1,5 \cdot h_{ef}$	120			1,0
		$1,5 \cdot h_{ef}$	$3 \cdot h_{ef}$			2,0

Injection System VMU plus for masonry

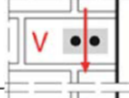
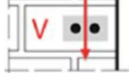
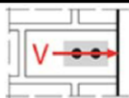
Performance - Solid lightweight concrete - LAC
Description of the brick, Spacing and edge distances, Group factor

Annex C44

Brick type: Solid lightweight concrete - LAC

Table C116: Characteristic values of resistance under tension and shear load

Anchor size	Sleeve	Effective anchorage depth	Characteristic resistance						
			Use category						
			d/d			w/d w/w			d/d w/d w/w
			40°C/24°C	80°C/50°C	120°C/72°C	40°C/24°C	80°C/50°C	120°C/72°C	All temperature ranges
			h_{ef}	$N_{Rk,b} = N_{Rk,p}^{1)}$			$N_{Rk,b} = N_{Rk,p}^{1)}$		
[mm]	[kN]								
Compressive strength $f_b \geq 2 \text{ N/mm}^2$									
M8	-	80	3,0	2,5	2,0	2,5	2,0	1,5	3,0
M8 / M10/ IG-M6	-	90	3,0	3,0	2,0	2,5	2,5	2,0	3,0
M10 / IG-M8	-	100	3,5	3,0	2,5	3,0	2,5	2,0	3,0
M16 / IG-M10	-	100	3,0	3,0	2,0	3,0	3,0	2,0	3,0
M8	12x80	80	2,5	2,5	2,0	2,5	2,0	1,5	3,0
M8 / M10/ IG-M6	16x85	85	3,0	2,5	2,0	3,0	2,5	2,0	3,0
	16x130	130	3,0	2,5	2,0	3,0	2,5	2,0	3,0
M12 / M16 / IG-M8 / IG-M10	20x85	85	2,5	2,5	2,0	2,5	2,5	2,0	3,0
	20x130	130							
	20x200	200							

- 1) Values are valid for c_{cr} , values in brackets are valid for single anchors with c_{min}
 2) For calculation of $V_{Rk,c}$ see ETAG029, Annex C
 3) The values are valid for steel 5.6 or higher. For steel 4.6 and 4.8 multiply $V_{Rk,b}$ by 0,8

Table C117: Displacements

Anchor size	Sleeve	h_{ef}	N	δ_N / N	δ_{N0}	$\delta_{N\infty}$	V	δ_{V0}	$\delta_{V\infty}$
		[mm]	[kN]	[mm/kN]	[mm]	[mm]	[kN]	[mm]	[mm]
M8	-	80	0,86	0,50	0,43	0,86	0,9	0,25	0,38
M8 / M10/ IG-M6	-	90							
M10 / IG-M8	-	100							
M16 / IG-M10	-	100							
M8	12x80	80	0,71	0,35	0,25	0,50	0,9	0,25	0,38
M8 / M10/ IG-M6	16x85	85							
	16x130	130							
M12 / M16 / IG-M8 / IG-M10	20x85	85							
	20x130	130							
	20x200	200							

Injection System VMU plus for masonry

Performance - Solid lightweight concrete - LAC
 Characteristic values of resistance, Displacements

Annex C45