

YDEEVNEDEKLARATION
DoP Nr. MKT- 621 - dk

1. Varetypens unikke identifikationskode: **MKT Injektionssystem VMU plus**
2. Type-, parti- eller serienummer eller en anden form for angivelse, ved hjælp af hvilken byggevaren kan identificeres som krævet i henhold til artikel 11, stk. 4:

ETA-13/0909, Annex A2, A3
Batch nummer: se pakning

3. Byggevarens tilsigtede anvendelse eller anvendelser i overensstemmelse med den gældende harmoniserede tekniske specifikation som påtænkt af fabrikanten:

Produkttype	Ekspansionsfrit forankringssystem VMU plus
For anvendelse i	Murværk
Option	b, c und d
Belastning	Statisk eller kvasi-statisk
Materiale	<p><u>Stål varmgalvaniseret:</u> Kun i tørre indeområder Størrelse: VMU-A, V-A: M8, M10, M12, M16 VMU-IG: M6, M8, M10</p> <p><u>Stål galvaniseret:</u> Kun i tørre indeområder Størrelse: VMU-A, V-A: M8, M10, M12, M16 VMU-IG: M6, M8, M10</p> <p><u>Rustfri Stål (stemplet A4):</u> Til inde- og udeområder uden særlige aggressive påvirkninger Størrelse: VMU-A, V-A: M8, M10, M12, M16 VMU-IG: M6, M8, M10</p> <p><u>Højkorrosionsbestandig Stål (stemplet HCR):</u> Til inde- og udeområder med særlige aggressive påvirkninger Størrelse: VMU-A, V-A: M8, M10, M12, M16 VMU-IG: M6, M8, M10</p>
Temperaturområde	<p>T_a: -40 °C til +40 °C</p> <p>T_b: -40 °C til +80 °C</p> <p>T_c: -40 °C til +120 °C</p>

4. Fabrikantens navn, registrerede firmabetegnelse eller registrerede varemærke og kontaktadresse som krævet i henhold til artikel 11, stk. 5:

MKT Metall-Kunststoff-Technik GmbH & Co. KG
Auf dem Immel 2
D - 67685 Weilerbach

5. I givet fald navn og kontaktadresse på den bemyndigede repræsentant, hvis mandat omfatter opgaverne i artikel 12, stk. 2: --

6. Systemet eller systemerne til vurdering og kontrol af konstanten af byggevarens ydeevne, jf. bilag V:
System 1

7. Hvis ydeevnedeklarationen vedrører en byggevare, der er omfattet af en harmoniseret standard: --

8. Hvis ydeevnedeklarationen vedrører en byggevare, for hvilken der er udstedt en europæisk teknisk vurdering:

Deutsches Institut für Bautechnik, Berlin

og udstedte:

ETA-13/0909

på grundlag af

ETAG 029

Det notificerede produktcertificeringsorgan 1343-CPR udførte kontrollen efter system 1:

- i) bestemmelse af varetypen på grundlag af typeprøvning (herunder stikprøveudtagning), typeberegning, tabelværdier eller deskriptiv dokumentation for byggevaren;
- ii) indledende inspektion af fabriksanlæg og fabrikkens egen produktionskontrol
- iii) kontinuerlig overvågning, vurdering og evaluering af fabrikkens egen produktionskontrol

og udstedte: Attest for byggevarens ydeevnes konstans 1343-CPR-M 550-14/08.14

9. Deklareret ydeevne:

Karakteristiske kendetegn	Beregningsmetode	Ydeevne	Harmoniserede tekniske specifikationer
De karakteristiske værdier for modstand af ankeret i murværket	ETAG 029, Annex C	ETA-13/0909, Annex C	ETAG 029
Minimum indbyrdes afstand	ETAG 029, Annex C	ETA-13/0909, Annex C	
Forskydning i anvendstilstand	ETAG 029, Annex C	ETA-13/0909, Annex C	

Hvis der er anvendt specifik teknisk dokumentation i medfør af artikel 37 eller 38, de krav varen opfylder:

--

10. Ydeevnen for den byggevare, der er anført i punkt 1 og 2, er i overensstemmelse med den deklarerede ydeevne i punkt 9.

Denne ydeevnedeklaration udstedes på eneansvar af den fabrikant, der er anført i punkt 4.

Underskrevet for fabrikanten og på dennes vegne af:

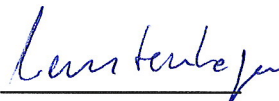
Stefan Weustenhagen
(CEO)
Weilerbach, 08.12.2016

i.V. 
Dipl.-Ing. Detlef Bigalke
(Chef for Produktudvikling)



Table C1: β - factor for job-site testing under tension loading

Brick-No. and abbreviation	Installation & Use category	β -Factor					
		T _a : 40°C / 24°C		T _b : 80°C / 50°C		T _c : 120°C / 72°C	
		d/d	w/d w/w	d/d	w/d w/w	d/d	w/d w/w
1 AAC6	All sizes	0,95	0,86	0,81	0,73	0,81	0,73
2 KS-NF	d ₀ ≤ 14 mm	0,93	0,80	0,87	0,74	0,65	0,56
	d ₀ ≥ 16 mm	0,93	0,93	0,87	0,87	0,65	0,65
3 KSL-3DF	d ₀ ≤ 12 mm	0,93	0,80	0,87	0,74	0,65	0,56
	d ₀ ≥ 16 mm	0,93	0,93	0,87	0,87	0,65	0,65
4 KSL-12DF	d ₀ ≤ 12 mm	0,93	0,80	0,87	0,74	0,65	0,56
	d ₀ ≥ 16 mm	0,93	0,93	0,87	0,87	0,65	0,65
5 MZ-DF	all sizes	0,86	0,86	0,86	0,86	0,73	0,73
6 Hiz-16DF							
7 Porotherm Homebric							
8 BGV-Thermo							
9 Calibric R+							
10 Urbanbric							
11 Brique creuse C40							
12 Blocchi Leggeri							
13 Doppio Uni							
14 Bloc creux B40	d ₀ ≤ 12 mm	0,93	0,80	0,87	0,74	0,65	0,56
	d ₀ ≥ 16 mm	0,93	0,93	0,87	0,87	0,65	0,65
15 Solid lightweight concrete	d ₀ ≤ 12 mm	0,93	0,80	0,87	0,74	0,65	0,56
	d ₀ ≥ 16 mm	0,93	0,93	0,87	0,87	0,65	0,65

Injection System VMU plus for masonry

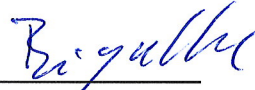
Performances

β - factors for job site testing under tension load

Annex C1

Table C2: Characteristic steel resistance under tension and shear load

Anchor type Anchor size			VMU-IG			VMU-A, V-A			
			M6	M8	M10	M8	M10	M12	M16
Characteristic tension resistance									
Steel, property class 4.6	$N_{RK,s}$	[kN]	-	-	-	15	23	34	63
	γ_{Ms}	[-]	-			2,0			
Steel, property class 4.8	$N_{RK,s}$	[kN]	-	-	-	15	23	34	63
	γ_{Ms}	[-]	-			1,5			
Steel, property class 5.6	$N_{RK,s}$	[kN]	10	18	29	18	29	42	79
	γ_{Ms}	[-]	2,0			2,0			
Steel, property class 5.8	$N_{RK,s}$	[kN]	10	17	29	18	29	42	79
	γ_{Ms}	[-]	1,5			1,5			
Steel, property class 8.8	$N_{RK,s}$	[kN]	16	27	46	29	46	67	126
	γ_{Ms}	[-]	1,5			1,5			
Stainless steel A4 / HCR, property class 70	$N_{RK,s}$	[kN]	14	26	41	26	41	59	110
	γ_{Ms}	[-]	1,87			1,87			
Stainless steel A4 / HCR, property class 80	$N_{RK,s}$	[kN]	16	29	46	29	46	67	126
	γ_{Ms}	[-]	1,6			1,6			
Characteristic shear resistance									
Steel, property class 4.6	$V_{RK,s}$	[kN]	-	-	-	7	12	17	31
	γ_{Ms}	[-]	-			1,67			
Steel, property class 4.8	$V_{RK,s}$	[kN]	-	-	-	7	12	17	31
	γ_{Ms}	[-]	-			1,25			
Steel, property class 5.6	$V_{RK,s}$	[kN]	5	9	15	9	15	21	39
	γ_{Ms}	[-]	1,67			1,67			
Steel, property class 5.8	$V_{RK,s}$	[kN]	5	9	15	9	15	21	39
	γ_{Ms}	[-]	1,25			1,25			
Steel, property class 8.8	$V_{RK,s}$	[kN]	8	14	23	15	23	34	63
	γ_{Ms}	[-]	1,25			1,25			
Stainless steel A4 / HCR, property class 70	$V_{RK,s}$	[kN]	7	13	20	13	20	30	55
	γ_{Ms}	[-]	1,56			1,56			
Stainless steel A4 / HCR, property class 80	$V_{RK,s}$	[kN]	8	15	23	15	23	34	63
	γ_{Ms}	[-]	1,33			1,33			
Characteristic bending moment									
Steel, property class 4.6	$M_{RK,s}$	[Nm]	-	-	-	15	30	52	133
	γ_{Ms}	[-]	-			1,67			
Steel, property class 4.8	$M_{RK,s}$	[Nm]	-	-	-	15	30	52	133
	γ_{Ms}	[-]	-			1,25			
Steel, property class 5.6	$M_{RK,s}$	[Nm]	8	19	37	19	37	66	167
	γ_{Ms}	[-]	1,67			1,67			
Steel, property class 5.8	$M_{RK,s}$	[Nm]	8	19	37	19	37	66	167
	γ_{Ms}	[-]	1,25			1,25			
Steel, property class 8.8	$M_{RK,s}$	[Nm]	12	30	60	30	60	105	266
	γ_{Ms}	[-]	1,25			1,25			
Stainless steel A4 / HCR, property class 70	$M_{RK,s}$	[Nm]	11	26	52	26	52	92	233
	γ_{Ms}	[-]	1,56			1,56			
Stainless steel A4 / HCR, property class 80	$M_{RK,s}$	[Nm]	12	30	60	30	60	105	266
	γ_{Ms}	[-]	1,33			1,33			

Injection System VMU plus for masonry

Performances

Characteristic steel resistance under tension and shear load

Annex C2

Spacing and edge distance

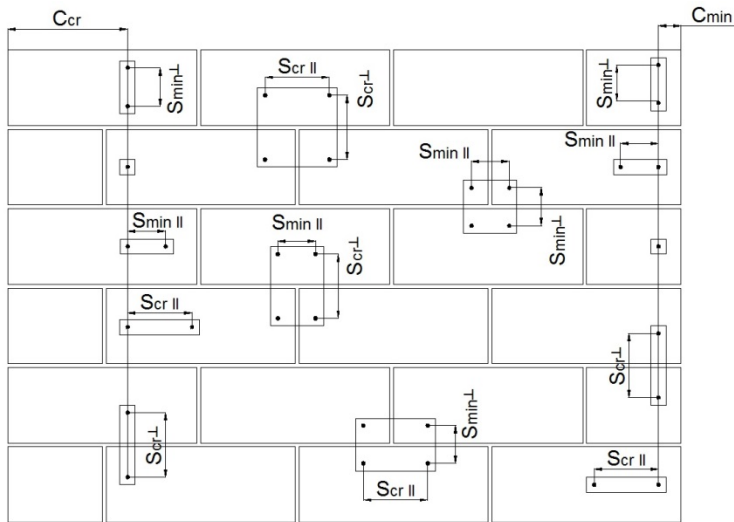

C_{cr} = Characteristic edge distance
 C_{min} = Minimum edge distance
 S_{cr} = Characteristic spacing
 S_{min} = Minimum spacing

$S_{cr,II}; (S_{min,II})$ = Characteristic (minimum) spacing for anchors placed parallel to bed joint
 $S_{cr,\perp}; (S_{min,\perp})$ = Characteristic (minimum) spacing for anchors placed perpendicular to bed joint

Load direction \ Anchor position	Tension load	Shear load parallel to free edge	Shear load perpendicular to free edge
Anchors places parallel to bed joint $S_{cr,II}; (S_{min,II})$			
Anchors places perpendicular to bed joint $S_{cr,\perp}; (S_{min,\perp})$			

$\alpha_{g,N,II}$ = Group factor in case of tension load for anchors placed parallel to the bed joint
 $\alpha_{g,V,II}$ = Group factor in case of shear load for anchors placed parallel to the bed joint
 $\alpha_{g,N,\perp}$ = Group factor in case of tension load for anchors placed perpendicular to the bed joint
 $\alpha_{g,V,\perp}$ = Group factor in case of shear load for anchors placed perpendicular to the bed joint

Group of 2 anchors: $N_{RK}^g = \alpha_{g,N} * N_{RK}$ and $V_{RK}^g = \alpha_{g,V} * V_{RK}$

Group of 4 anchors: $N_{RK}^g = \alpha_{g,N,II} * \alpha_{g,N,\perp} * N_{RK}$ and $V_{RK}^g = \alpha_{g,V,II} * \alpha_{g,V,\perp} * V_{RK}$

$(N_{RK}: N_{RK,b}$ or $N_{RK,b,j}$ for C_{cr})
 $(V_{RK}: V_{RK,c}; V_{RK,c,j}; V_{RK,b}$ or $V_{RK,b,j}$ for C_{cr})
 (with the relevant α_g)

Injection System VMU plus for masonry

Performances
 Edge distance and Spacing

Annex C3

Brick type: Autoclaved Aerated Concrete – AAC6

Table C3: Description of the brick

Brick type	Autoclaved Aerated Concrete AAC6		
Bulk density	ρ [kg/dm ³]	0,6	
Compressive strength	$f_b \geq$ [N/mm ²]	6	
Code	EN 771-4		
Producer (country code)	e.g. Porit (DE)		
Brick dimensions	[mm]	499 x 240 x 249	
Drilling method	Rotary		

Table C4: Spacing and edge distance

Anchor size			All sizes
Edge distance	C_{cr}	[mm]	$1,5 \cdot h_{ef}$
Minimum edge distance	$C_{min,N}$	[mm]	75
	$C_{min,V,II}$ ($C_{min,v,\perp}$) ¹⁾	[mm]	$75 (1,5 \cdot h_{ef})$
Spacing	S_{cr}	[mm]	$3 \cdot h_{ef}$
Minimum spacing	S_{min}	[mm]	100

¹⁾ $C_{min,v,II}$ for shear loading parallel to the free edge; $C_{min,v,\perp}$ for shear loading perpendicular free edge

Table C5: Group factor for anchor group in case of tension loading

Configuration		with c [mm] \geq	with s [mm] \geq			
II: anchors placed parallel to horizontal joint		125 (120 for M8)	100	$\alpha_{g,N,II}$	[-]	1,8
		$1,5 \cdot h_{ef}$	$3 \cdot h_{ef}$			2,0
⊥: anchors placed perpendicular to horizontal joint		75	100	$\alpha_{g,N,\perp}$	[-]	1,4
		$1,5 \cdot h_{ef}$	$3 \cdot h_{ef}$			2,0

Table C6: Group factor for anchor group in case of shear loading parallel to free edge

Configuration		with c [mm] \geq	with s [mm] \geq			
II: anchors placed parallel to horizontal joint		75	100	$\alpha_{g,V,II}$	[-]	1,2
		$1,5 \cdot h_{ef}$	$3 \cdot h_{ef}$			2,0
⊥: anchors placed perpendicular to horizontal joint		$1,5 \cdot h_{ef}$	$3 \cdot h_{ef}$	$\alpha_{g,V,\perp}$		2,0

Injection System VMU plus for masonry

Performances - Autoclaved Aerated Concrete - AAC6
Description of the brick, Spacing and edge distance, Group factors

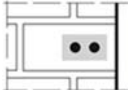
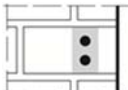
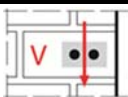
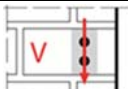
Annex C4

Brick type: Autoclaved Aerated Concrete – AAC6

Table C7: Group factor for anchor group in case of shear loading perpendicular to free edge

Configuration		with c [mm] ≥	with s [mm] ≥			
II: anchors placed parallel to horizontal joint		1,5*hef	3,0*hef	$\alpha_{g,V,II}$	[-]	2,0
I: anchors placed perpendicular to horizontal joint		1,5*hef	3,0*hef	$\alpha_{g,V,I}$		2,0

Table C8: Characteristic values of resistance under tension and shear loads

Anchor size	Effective anchorage depth	Characteristic resistance						
		Use category						
		d/d			w/w			d/d
		40°C/24°C	80°C/50°C	120°C/72°C	40°C/24°C	80°C/50°C	120°C/72°C	w/d
								All temperature ranges
	hef	$N_{Rk,b} = N_{Rk,p}^{1)}$			$N_{Rk,b} = N_{Rk,p}^{1)}$			$V_{Rk,b}^{2)3)}$
	[mm]	[kN]						
Compressive strength $f_b \geq 6 \text{ N/mm}^2$								
M8	80	2,5 (2,0)	2,5 (1,5)	2,0 (1,2)	2,5 (1,5)	2,0 (1,5)	1,5 (1,2)	6,0
M10/IG-M6	90	4,0 (2,5)	3,0 (2,0)	2,5 (1,5)	3,5 (2,5)	3,0 (2,0)	2,5 (1,5)	10,0
M12/IG-M8	100	5,0 (3,5)	4,0 (3,0)	3,0 (2,5)	4,5 (3,0)	3,5 (2,5)	3,0 (2,5)	10,0
M16/IG-M10	100	6,5 (4,5)	5,5 (3,5)	4,0 (3,0)	5,5 (4,0)	5,0 (3,5)	4,0 (3,0)	10,0

1) Values are valid for c_{cr} , values in brackets are valid for single anchors with c_{min}

2) For calculation of $V_{Rk,c}$ see ETAG029, Annex C;

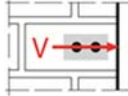
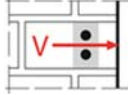
3) The values are valid for steel 5.6 or higher. For steel 4.6 and 4.8 multiply $V_{Rk,b}$ by 0,8

Table C9: Displacements

Anchor size	hef	N	$\delta N / N$	δN_0	δN_∞	V	δV_0	δV_∞
	[mm]	[kN]	[mm/kN]	[mm]	[mm]	[kN]	[mm]	[mm]
M8	80	0,9	0,18	0,16	0,32	1,3	0,8	1,20
M10/IG-M6	90	1,4		0,26	0,51	1,8	1,2	1,80
M12/IG-M8	100	1,8	0,08	0,14	0,29	2,1	1,4	2,10
M16/IG-M10	100	2,3		0,19	0,37	2,3	1,5	2,25

Injection System VMU plus for masonry

Performances - Autoclaved Aerated Concrete – AAC6
Group factor, Characteristic values of resistance, Displacements

Annex C5

Brick type: Calcium silicate solid brick KS-NF

Table C10: Description of the brick

Brick type	Calcium silicate solid brick KS-NF		
Bulk density	ρ [kg/dm ³]	2,0	
Compressive strength	$f_b \geq$ [N/mm ²]	10, 20 or 27	
Code	EN 771-2		
Producer (country code)	e.g. Wemding (DE)		
Brick dimensions	[mm]	240 x 115 x 71	
Drilling method	Hammer		

Table C11: Spacing and edge distance

Anchor size			All sizes
Edge distance	c_{cr}	[mm]	$1,5 \cdot h_{ef}$
Minimum edge distance	c_{min}	[mm]	60
Spacing	s_{cr}	[mm]	$3 \cdot h_{ef}$
Minimum spacing	s_{min}	[mm]	120

Table C12: Group factor for anchor group in case of tension loading

Configuration		with c [mm] \geq	with s [mm] \geq			
II: anchors placed parallel to horizontal joint 	60	120	$\alpha_{g,N,II}$	[-]	1,0	
	140	120			1,5	
	$1,5 \cdot h_{ef}$	$3 \cdot h_{ef}$			2,0	
⊥: anchors placed perpendicular to horizontal joint 	60	120	$\alpha_{g,N,\perp}$	[-]	0,5	
	$1,5 \cdot h_{ef}$	120			1,0	
	$1,5 \cdot h_{ef}$	$3 \cdot h_{ef}$			2,0	

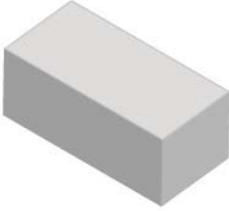
Table C13: Group factor for anchor group in case of shear loading parallel to free edge

Configuration		with c [mm] \geq	with s [mm] \geq			
II: anchors placed parallel to horizontal joint 	60	120	$\alpha_{g,V,II}$	[-]	1,0	
	115	120			1,7	
	$1,5 \cdot h_{ef}$	$3 \cdot h_{ef}$			2,0	
⊥: anchors placed perpendicular to horizontal joint 	60	120	$\alpha_{g,V,\perp}$	[-]	1,0	
	$1,5 \cdot h_{ef}$	120			1,0	
	$1,5 \cdot h_{ef}$	$3 \cdot h_{ef}$			2,0	

Table C14: Group factor for anchor group in case of shear loading perpendicular to free edge

Configuration		with c [mm] \geq	with s [mm] \geq			
II: anchors placed parallel to horizontal joint 	60	120	$\alpha_{g,V,II}$	[-]	1,0	
	$1,5 \cdot h_{ef}$	$3 \cdot h_{ef}$			2,0	
⊥: anchors placed perpendicular to horizontal joint 	60	120	$\alpha_{g,V,\perp}$	[-]	1,0	
	$1,5 \cdot h_{ef}$	$3 \cdot h_{ef}$			2,0	

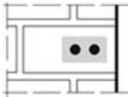
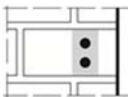
Injection System VMU plus for masonry

Performances - Calcium solid brick KS-NF
Description, Spacing and edge distance, Group factor

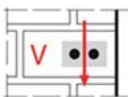
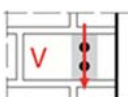
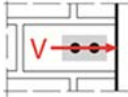
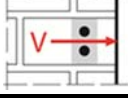
Annex C6

Brick type: Calcium silicate solid brick KS-NF

Table C15: Characteristic values of resistance under tension and shear loads

Anchor size	Sleeve	Effective anchorage depth	Characteristic resistance						
			Use category						
			d/d			w/d			d/d
			40°C/24°C	80°C/50°C	120°C/72°C	40°C/24°C	80°C/50°C	120°C/72°C	All temperature ranges
h _{ef}	N _{Rk,b} = N _{Rk,p} ¹⁾			N _{Rk,b} = N _{Rk,p} ¹⁾			V _{Rk,b} ²⁾³⁾		
		[mm]	[kN]						
Compressive strength f_b ≥ 10 N/mm²									
M8	-	80							2,5 (1,5)
M10 / IG-M6	-	90	4,5 (2,0)	4,5 (2,0)	3,0 (1,5)	3,5 (1,5)	3,5 (1,5)	2,5 (1,2)	3,0 (2,0)
M12 / IG-M8	-	100							2,5 (1,5)
M16 / IG-M10	-	100	3,5 (1,5)	3,5 (1,5)	2,5 (1,2)	3,0 (1,5)	3,5 (1,5)	2,0 (0,9)	2,5 (1,5)
M8	12x80	80	3,5 (1,5)	3,5 (1,5)	2,5 (1,2)	3,5 (1,5)	3,0 (1,5)	2,5 (1,2)	2,5 (1,5)
M8 / M10 / IG-M6	16x85	85	3,5 (1,5)	3,0 (1,5)	2,0 (0,9)	3,5 (1,5)	3,0 (1,5)	2,5 (1,2)	2,5 (1,5)
	16x130	130	3,5 (1,5)	3,0 (1,5)	2,0 (0,9)	3,5 (1,5)	3,0 (1,5)	2,5 (1,2)	2,5 (1,5)
M12 / M16 / IG-M8 / IG-M10	20x85	85							
	20x130	130	3,0 (1,5)	2,5 (1,2)	2,0 (0,9)	3,0 (1,5)	2,5 (1,2)	2,0 (0,9)	2,5 (1,5)
	20x200	200							
Compressive strength f_b ≥ 20 N/mm²									
M8	-	80							4,0 (2,5)
M10 / IG-M6	-	90	6,0 (3,0)	5,5 (2,5)	4,0 (2,0)	5,0 (2,5)	5,0 (2,5)	3,5 (1,5)	4,5 (2,5)
M12 / IG-M8	-	100							4,0 (2,5)
M16 / IG-M10	-	100	5,0 (2,5)	5,0 (2,5)	3,5 (1,5)	5,0 (2,5)	5,0 (2,5)	3,5 (1,5)	4,0 (2,5)
M8	12x80	80	5,5 (2,5)	5,0 (2,5)	3,5 (1,5)	4,5 (2,0)	4,5 (2,0)	3,0 (1,5)	4,0 (2,5)
M8 / M10 / IG-M6	16x85	85	5,0 (2,5)	4,5 (2,0)	3,5 (1,5)	5,0 (2,5)	4,5 (2,0)	3,5 (1,5)	4,0 (2,5)
	16x130	130	5,0 (2,5)	4,5 (2,0)	3,5 (1,5)	5,0 (2,5)	4,5 (2,0)	3,5 (1,5)	4,0 (2,5)
M12 / M16 / IG-M8 / IG-M10	20x85	85							
	20x130	130	4,0 (2,0)	4,0 (2,0)	3,0 (1,5)	4,0 (2,0)	4,0 (2,0)	3,0 (1,5)	4,0 (2,5)
	20x200	200							

- 1) Values are valid for c_{cr}, values in brackets are valid for single anchors with c_{min}
 2) For c_{cr} calculation of V_{Rk,c} see ETAG 029, Annex C; values in brackets V_{Rk,c} = V_{Rk,b} for single anchors with c_{min}
 3) The values are valid for steel 5.6 or higher. For steel 4.6 and 4.8 multiply V_{Rk,b} by 0,8.

Injection System VMU plus for masonry

Performances - Calcium solid brick KS-NF
 Characteristic values of resistance

Annex C7

Brick type: Calcium silicate solid brick KS-NF

Table C16: Characteristic values of resistance under tension and shear loads (continue)

Anchor size	Sleeve	Effective anchorage depth	Characteristic resistance						
			Use category						
			d/d			w/d			d/d
			w/w			w/w			w/d
			w/w			w/w			w/w
40°C/24°C	80°C/50°C	120°C/72°C	40°C/24°C	80°C/50°C	120°C/72°C	All temperature ranges			
h_{ef}	$N_{Rk,b} = N_{Rk,p}^{1)}$			$N_{Rk,b} = N_{Rk,p}^{1)}$			$V_{Rk,b}^{2)3)}$		
[mm]	[kN]								
Compressive strength $f_b \geq 27 \text{ N/mm}^2$									
M8	-	80							4,5 (2,5)
M10 / IG-M6	-	90	7,0 (3,5)	6,5 (3,0)	5,0 (2,5)	6,0 (3,0)	5,5 (2,5)	4,0 (2,0)	5,5 (3,0)
M12 / IG-M8	-	100							4,5 (2,5)
M16 / IG-M10	-	100	6,0 (3,0)	5,5 (2,5)	4,5 (2,0)	6,0 (3,0)	5,5 (2,5)	4,0 (2,0)	4,5 (2,5)
M8	12x80	80	6,5 (3,0)	6,0 (3,0)	4,5 (2,0)	5,5 (2,5)	5,0 (2,5)	3,5 (1,5)	4,5 (2,5)
M8 / M10 / IG-M6	16x85	85	5,5 (2,5)	5,0 (2,5)	4,0 (2,0)	5,5 (2,5)	5,0 (2,5)	4,0 (2,0)	4,5 (2,5)
	16x130	130	5,5 (2,5)	5,0 (2,5)	4,0 (2,0)	5,5 (2,5)	5,0 (2,5)	4,0 (2,0)	4,5 (2,5)
M12 / M16 / IG-M8 / IG-M10	20x85	85							
	20x130	130	5,0 (2,5)	4,5 (2,0)	3,5 (1,5)	5,0 (2,5)	4,5 (2,0)	3,5 (1,5)	4,5 (2,5)
	20x200	200							

- 1) Values are valid for c_{cr} , values in brackets are valid for single anchors with c_{min}
 2) For c_{cr} calculation of $V_{Rk,c}$ see ETAG 029, Annex C; values in brackets $V_{Rk,c} = V_{Rk,b}$ for single anchors with c_{min}
 3) The values are valid for steel 5.6 or higher. For steel 4.6 and 4.8 multiply $V_{Rk,b}$ by 0,8

Table C17: Displacements

Anchor size	Sleeve	h_{ef}	N	δ_N / N	δ_{N0}	$\delta_{N\infty}$	V	δ_{V0}	$\delta_{V\infty}$
		[mm]	[kN]	[mm/kN]	[mm]	[mm]	[kN]	[mm]	[mm]
M8	-	80	2,0	0,15	0,30	0,60	1,7	0,90	1,35
M10 / IG-M6	-	90							
M12 / IG-M8	-	100							
M16 / IG-M10	-	100	1,7		0,26	0,51	1,7	0,90	1,35
M8	12x80	80	1,4		0,21	0,43			
	M8 / M10 / IG-M6	16x85							
M12 / M16 / IG-M8 / IG-M10	16x130	130	1,3	0,19	0,39				
	M12 / M16 / IG-M8 / IG-M10	20x85				85			
	M12 / M16 / IG-M8 / IG-M10	20x130				130			
M12 / M16 / IG-M8 / IG-M10	20x200	200							

Injection System VMU plus for masonry

Annex C8

Performances - Calcium solid brick KS-NF
 Characteristic values of resistance (continue), Displacements

Brick type: Calcium silicate hollow brick KSL-3DF

Table C18: Description of the brick

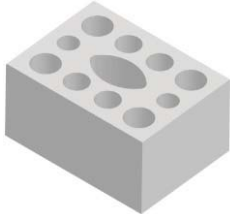
Brick type	Calcium silicate hollow brick KSL-3DF		
Bulk density	ρ [kg/dm ³]	1,4	
Compressive strength	$f_b \geq$ [N/mm ²]	8, 12 or 14	
Code	EN 771-2		
Producer (country code)	e.g. Wemding (DE)		
Brick dimensions	[mm]	240 x 175 x 113	
Drilling method	Rotary		

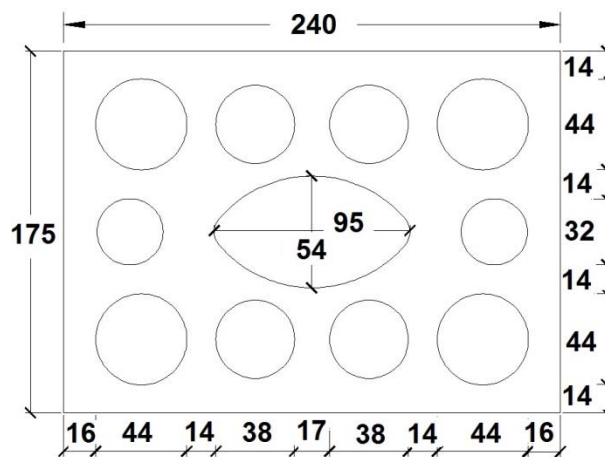
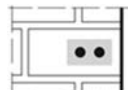
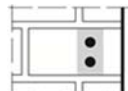

Table C19: Spacing and edge distance

Anchor size			All sizes
Edge distance	C_{cr}	[mm]	100 (120) ¹⁾
Minimum edge distance	C_{min}	[mm]	60
Spacing	$S_{cr, }$	[mm]	240
	$S_{cr,\perp}$	[mm]	120
Minimum spacing	S_{min}	[mm]	120

¹⁾ Value in brackets for VM-SH 20x85; VM-SH 20x130 and VM-SH 20x200

Table C20: Group factor for anchor group in case of tension loading

Configuration		with c [mm] \geq	with s [mm] \geq			
: anchors placed parallel to horizontal joint		60	120	$\alpha_{g,N, }$	[-]	1,5
		C_{cr}	240			2,0
		160	120			2,0
⊥: anchors placed perpendicular to horizontal joint		60	120	$\alpha_{g,N,\perp}$	[-]	1,0
		C_{cr}	120			2,0

Injection System VMU plus for masonry

Performances - Calcium silicate hollow brick KSL-3DF
Description of the brick, Spacing and edge distance, Group factor

Annex C9

Brick type: Calcium silicate hollow brick KSL-3DF

Table C21: Group factor for anchor group in case of shear loading parallel to free edge

Configuration		with c [mm] ≥	with s [mm] ≥			
II: anchors placed parallel to horizontal joint		60	120	$\alpha_{g,V,II}$	[-]	1,0
		160	120			1,6
		C_{Cr}	240			2,0
⊥: anchors placed perpendicular to horizontal joint		60	120	$\alpha_{g,V,\perp}$	[-]	1,0
		C_{Cr}	120			2,0

Table C22: Group factor for anchor group in case of shear loading perpendicular to free edge

Configuration		with c [mm] ≥	with s [mm] ≥			
II: anchors placed parallel to horizontal joint		60	120	$\alpha_{g,V,II}$	[-]	1,0
		C_{Cr}	240			2,0
⊥: anchors placed perpendicular to horizontal joint		60	120	$\alpha_{g,V,\perp}$	[-]	1,0
		C_{Cr}	120			2,0

Table C23: Characteristic values of resistance under tension and shear loads

Anchor size	Sleeve	Effective anchorage depth	Characteristic resistance						
			Use category						
			d/d			w/d; w/w			d/d; w/d; w/w
			40°C/24°C	80°C/50°C	120°C/72°C	40°C/24°C	80°C/50°C	120°C/72°C	All temperature ranges
		h_{ef}	$N_{Rk,b} = N_{Rk,p}^{1)}$			$N_{Rk,b} = N_{Rk,p}^{1)}$			$V_{Rk,b}^{4)}$
		[mm]	[kN]						
Compressive strength $f_b \geq 8 \text{ N/mm}^2$									
M8	12x80	80					1,2	0,9	$2,5^{2)}$ (0,9) ³⁾
M8 / M10 / IG-M6	16x85	85	1,5	1,5	1,2	1,5	1,5	1,2	$4,0^{2)}$ (1,5) ³⁾
	16x130	130					1,5	1,2	$4,0^{2)}$ (1,5) ³⁾
M12 / M16 / IG-M8 / IG-M10	20x85	85							
	20x130	130	4,5	4,0	3,0	4,5	4,0	3,0	$4,0^{2)}$ (1,5) ³⁾
	20x200	200							
Compressive strength $f_b \geq 12 \text{ N/mm}^2$									
M8	12x80	80	2,0	2,0	1,5	2,0	1,5	1,2	$3,0^{2)}$ (1,2) ³⁾
M8 / M10 / IG-M6	16x85	85	2,0	2,0	1,5	2,0	2,0	1,5	$4,5^{2)}$ (1,5) ³⁾
	16x130	130	2,5	2,5	1,5	2,5	2,5	1,5	$4,5^{2)}$ (1,5) ³⁾
M12 / M16 / IG-M8 / IG-M10	20x85	85							
	20x130	130	6,0	5,5	4,0	6,0	5,5	4,0	$4,5^{2)}$ (1,5) ³⁾
	20x200	200							

1) Values are valid for C_{Cr} and C_{min}

2) $V_{Rk,c,II} = V_{Rk,b}$ valid for shear load parallel to free edge

3) $V_{Rk,c,\perp} = V_{Rk,b}$ (values in brackets) valid for shear load in direction to free edge

4) The values are valid for steel 5.6 or higher. For steel 4.6 and 4.8 multiply $V_{Rk,b}$ by 0,8

Injection System VMU plus for masonry

Performances - Calcium silicate hollow brick KSL-3DF
Group factor, Characteristic values of resistance

Annex C10

Brick type: Calcium silicate hollow brick KSL-3DF

Table C24: Characteristic values of resistance under tension and shear loads (continue)

Anchor size	Sleeve	Effective anchorage depth	Characteristic resistance						
			Use category						
			d/d			w/d; w/w			d/d; w/d; w/w
			40°C/24°C	80°C/50°C	120°C/72°C	40°C/24°C	80°C/50°C	120°C/72°C	All temperature ranges
h_{ef}	$N_{Rk,b} = N_{Rk,p}^{1)}$			$N_{Rk,b} = N_{Rk,p}^{1)}$			$V_{Rk,b}^{4)}$		
		[mm]	[kN]						
Compressive strength $f_b \geq 14 \text{ N/mm}^2$									
M8	12x80	80	2,5	2,5	1,5	2,0	2,0	1,5	3,5 ²⁾ (1,5) ³⁾
M8 / M10 / IG-M6	16x85	85	2,5	2,5	1,5	2,5	2,5	1,5	6,0 ²⁾ (2,0) ³⁾
	16x130	130	2,5	2,5	2,0	2,5	2,5	2,0	6,0 ²⁾ (2,0) ³⁾
M12 / M16 / IG-M8 / IG-M10	20x85	85	6,5	6,0	4,5	6,5	6,0	4,5	6,0 ²⁾ (2,0) ³⁾
	20x130	130							
	20x200	200							

1) Values are valid for c_{cr} and c_{min}

2) $V_{Rk,c,II} = V_{Rk,b}$ valid for shear load parallel to free edge

3) $V_{Rk,c,I} = V_{Rk,b}$ (values in brackets) valid for shear load in direction to free edge

4) The values are valid for steel 5.6 or higher. For steel 4.6 and 4.8 multiply $V_{Rk,b}$ by 0,8

Table C25: Displacements

Anchor size	Sleeve	h_{ef}	N	δ_N / N	δ_{N0}	$\delta_{N\infty}$	V	δ_{V0}	$\delta_{V\infty}$
		[mm]							
M8	12x80	80	0,71	0,90	0,64	1,29	1,0	1,0	1,50
M8 / M10 / IG-M6	16x85	85							
		16x130	130	1,86	1,67	3,34	1,7	1,9	2,85
M12 / M16 / IG-M8 / IG-M10	20x85	85							
		20x130	130						
	20x200	200							

Injection System VMU plus for masonry

Performance - Calcium silicate hollow brick KSL-3DF
Characteristic values of resistance, Displacements

Annex C11

Brick type: Calcium silicate hollow brick KSL-12DF

Table C26: Description of the brick

Brick type	Calcium silicate hollow brick KSL-12DF		
Bulk density	ρ [kg/dm ³]	1,4	
Compressive strength	$f_b \geq$ [N/mm ²]	10, 12 or 16	
Code	EN 771-2		
Producer (country code)	e.g. Wemding (DE)		
Brick dimensions	[mm]	498 x 175 x 238	
Drilling method	Rotary		

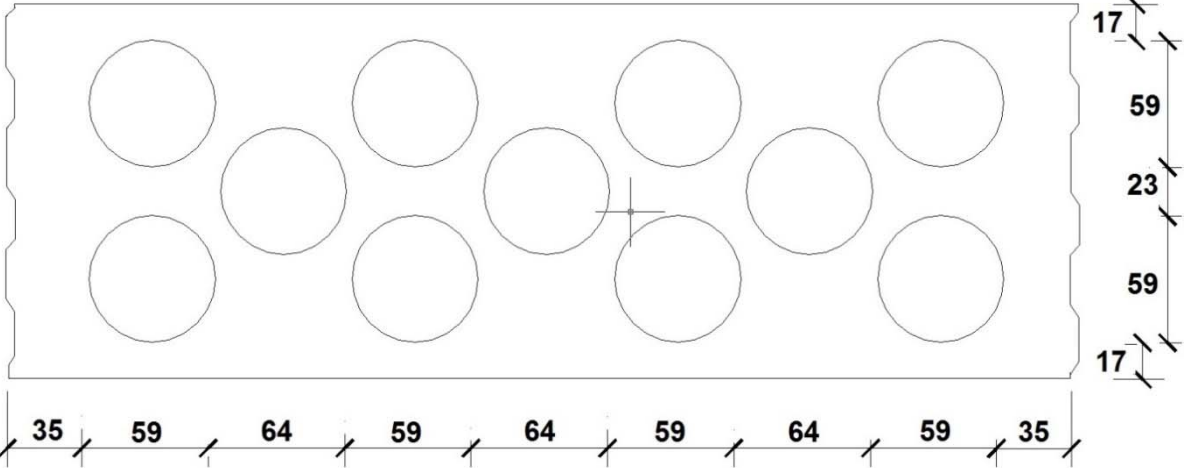

Table C27: Spacing and edge distances

Anchor size		All sizes	
Edge distance	C_{cr} [mm]	100 (120) ¹⁾	
Minimum edge distance	$C_{min}^{2)}$ [mm]	100 (120) ¹⁾	
Spacing	$S_{cr,II}$ [mm]	498	
	$S_{cr,\perp}$ [mm]	238	
Minimum spacing	S_{min} [mm]	120	

1) Value in brackets for VM-SH 20x85 and VM-SH 20x130

2) For $V_{Rk,c}$: C_{min} according to ETAG 029, Annex C

Table C28: Group factor for anchor group in case of tension loading

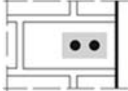
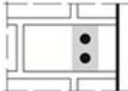
Configuration		with c [mm] \geq	with s [mm] \geq			
II: anchors placed parallel to horizontal joint		100	120	$\alpha_{g,N,II}$	[-]	1,0
		C_{cr}	498			2,0
⊥: anchors placed perpendicular to horizontal joint		100	120	$\alpha_{g,N,\perp}$		1,0
		C_{cr}	238			2,0

Injection System VMU plus for masonry

Performance - Calcium silicate hollow brick KSL-12DF

Description of the brick, Spacing and edge distances, Group factor

Annex C12

Brick type: Calcium silicate hollow brick KSL-12DF

Table C29: Group factor for anchor group in case of shear loading parallel to free edge

Configuration		with c [mm] ≥	with s [mm] ≥			
: anchors placed parallel to horizontal joint		C_{cr}	498	$\alpha_{g,V, }$	[-]	2,0
⊥: anchors placed perpendicular to horizontal joint		C_{cr}	238	$\alpha_{g,V,\perp}$		2,0

Table C30: Group factor for anchor group in case of shear load perpendicular to free edge

Configuration		with c [mm] ≥	with s [mm] ≥			
: anchors placed parallel to horizontal joint		C_{cr}	498	$\alpha_{g,V, }$	[-]	2,0
⊥: anchors placed perpendicular to horizontal joint		C_{cr}	238	$\alpha_{g,V,\perp}$		2,0

Table C31: Characteristic values of resistance under tension and shear loads

Anchor size	Sleeve	Effective anchorage depth	Characteristic resistance						
			Use category						
			d/d			w/d; w/w			d/d w/d w/w
			40°C/24°C	80°C/50°C	120°C/72°C	40°C/24°C	80°C/50°C	120°C/72°C	All temperature ranges
h_{ef}	$N_{Rk,b} = N_{Rk,p}^{1)}$			$N_{Rk,b} = N_{Rk,p}^{1)}$			$V_{Rk,b}^{2)3)}$		
		[mm]	[kN]						
Compressive strength $f_b \geq 10 \text{ N/mm}^2$									
M8	12x80	80	0,6	0,6	0,4	0,5	0,5	0,4	2,5
M8 / M10 / IG-M6	16x85	85	0,6	0,6	0,4	0,6	0,6	0,4	5,5
	16x130	130	2,5	2,5	2,0	2,5	2,5	2,0	5,5
M12 / M16 / IG-M8 / IG-M10	20x85	85	1,5	1,5	0,9	1,5	1,5	0,9	5,5
	20x130	130	2,5	2,5	2,0	2,5	2,5	2,0	5,5
Compressive strength $f_b \geq 12 \text{ N/mm}^2$									
M8	12x80	80	0,75	0,6	0,5	0,6	0,6	0,4	3,0
M8 / M10 / IG-M6	16x85	85	0,75	0,6	0,5	0,75	0,6	0,5	6,5
	16x130	130	3,0	3,0	2,0	3,0	3,0	2,0	6,5
M12 / M16 / IG-M8 / IG-M10	20x85	85	1,5	1,5	1,2	1,5	1,5	1,2	6,5
	20x130	130	3,0	3,0	2,0	3,0	3,0	2,0	6,5

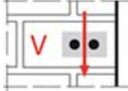
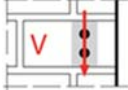
1) Values are valid for C_{cr} and C_{min}

2) Calculation of $V_{Rk,c}$ see ETAG 029, Annex C, except for shear load parallel to free edge with $c \geq 120 \text{ mm}$: $V_{Rk,c,||} = V_{Rk,b}$

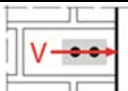
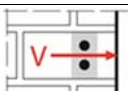
3) The values are valid for steel 5.6 or higher. For steel 4.6 and 4.8 multiply $V_{Rk,b}$ by 0,8

Injection System VMU plus for masonry

Performance - Calcium silicate hollow brick KSL-12DF
Group factor, Characteristic values of resistance

Annex C13

Brick type: Calcium silicate hollow brick KSL-12DF

Table C32: Characteristic values of resistance under tension and shear loads (continue)

Anchor size	Sleeve	Effective anchorage depth	Characteristic resistance						
			Use category						
			d/d			w/d; w/w			d/d w/d w/w
			40°C/24°C	80°C/50°C	120°C/72°C	40°C/24°C	80°C/50°C	120°C/72°C	All temperature ranges
h_{ef}	$N_{Rk,b} = N_{Rk,p}^{1)}$			$N_{Rk,b} = N_{Rk,p}^{1)}$			$V_{Rk,b}^{2)3)}$		
		[mm]	[kN]						
Compressive strength $f_b \geq 16 \text{ N/mm}^2$									
M8	12x80	80	0,9	0,9	0,6	0,75	0,75	0,5	3,5
M8 / M10 / IG-M6	16x85	85	0,9	0,9	0,6	0,9	0,9	0,6	8,0
	16x130	130	4,0	3,5	2,5	4,0	3,5	2,5	8,0
M12 / M16 / IG-M8 / IG-M10	20x85	85	2,0	2,0	1,5	2,0	2,0	1,5	8,0
	20x130	130	4,0	3,5	2,5	4,0	3,5	2,5	8,0

1) Values are valid for C_{cr} and C_{min}

2) Calculation of $V_{Rk,c}$ see ETAG 029, Annex C, except for shear load parallel to free edge with $c \geq 120 \text{ mm}$: $V_{Rk,c,II} = V_{Rk,b}$

3) The values are valid for steel 5.6 or higher. For steel 4.6 and 4.8 multiply $V_{Rk,b}$ by 0,8

Table C33: Displacements

Anchor size	Sleeve	h_{ef}	N	δ_N / N	δ_{N0}	$\delta_{N\infty}$	V	δ_{V0}	$\delta_{V\infty}$
		[mm]	[kN]	[mm/kN]	[mm]	[mm]	[kN]	[mm]	[mm]
M8	12x80	80	0,26	0,90	0,23	0,46	1,0	1,3	1,95
M8 / M10 / IG-M6	16x85	85							
	16x130	130	1,14		1,03	2,06			
M12 / M16 / IG-M8 / IG-M10	20x85	85	0,57		0,51	1,03	2,3	2,5	3,75
	20x130	130	1,14	1,03	2,06				

Injection System VMU plus for masonry

Performance - Calcium silicate hollow brick KSL-12DF
Characteristic values of resistance (continue), Displacements

Annex C14

Brick type: Clay solid brick Mz-DF

Table C34: Description of the brick

Brick type	Clay solid brick Mz-DF		
Bulk density ρ [kg/dm ³]	1,6		
Compressive strength $f_b \geq$ [N/mm ²]	10, 20 or 28		
Code	EN 771-1		
Producer (country code)	e.g. Unipor (DE)		
Brick dimensions [mm]	240 x 115 x 55		
Drilling method	Hammer		

Table C35: Spacing and edge distances

Anchor size			Alle Größen
Edge distance	c_{cr}	[mm]	$1,5 \cdot h_{ef}$
Minimum edge distance	c_{min}	[mm]	60
Spacing	s_{cr}	[mm]	$3 \cdot h_{ef}$
Minimum spacing	s_{min}	[mm]	120

Table C36: Group factor for anchor group in case of tension loading

Configuration		with c [mm] \geq	with s [mm] \geq	$\alpha_{g,N,\parallel}$	[-]	
II: anchors placed parallel to horizontal joint		60	120			
		$1,5 \cdot h_{ef}$	$3 \cdot h_{ef}$	2,0		
⊥: anchors placed perpendicular to horizontal joint		60	120	$\alpha_{g,N,\perp}$	[-]	0,5
		$1,5 \cdot h_{ef}$	120			1,0
		$1,5 \cdot h_{ef}$	$3 \cdot h_{ef}$			2,0

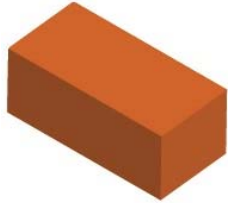
Table C37: Group factor for anchor group in case of shear loading parallel to free edge



Configuration		with c [mm] \geq	with s [mm] \geq	$\alpha_{g,V,\parallel}$	[-]	
II: anchors placed parallel to horizontal joint		60	120			
		90	120	1,1		
		$1,5 \cdot h_{ef}$	$3 \cdot h_{ef}$	2,0		
⊥: anchors placed perpendicular to horizontal joint		60	120	$\alpha_{g,V,\perp}$	[-]	0,5
		$1,5 \cdot h_{ef}$	120			1,0
		$1,5 \cdot h_{ef}$	$3 \cdot h_{ef}$			2,0

Table C38: Group factor for anchor group in case of shear load perpendicular to free edge

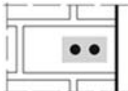
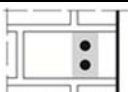
Configuration		with c [mm] \geq	with s [mm] \geq	$\alpha_{g,V,\parallel}$	[-]	
II: anchors placed parallel to horizontal joint		60	120			
		$1,5 \cdot h_{ef}$	120	1,0		
		$1,5 \cdot h_{ef}$	$3 \cdot h_{ef}$	2,0		
⊥: anchors placed perpendicular to horizontal joint		60	120	$\alpha_{g,V,\perp}$	[-]	0,5
		$1,5 \cdot h_{ef}$	120			1,0
		$1,5 \cdot h_{ef}$	$3 \cdot h_{ef}$			2,0

Injection System VMU plus for masonry

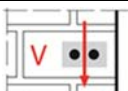
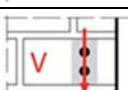
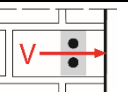
Performance - Clay solid brick Mz-DF

Description of the brick , Spacing and edge distances, Group factor

Annex C15

Brick type: Clay solid brick Mz-DF

Table C39: Characteristic values of resistance under tension and shear loads

Anchor size	Sleeve	Effective Anchorage depth	Characteristic resistance			
			Use category			
			d/d w/d w/w			d/d w/d w/w
			40°C/24°C	80°C/50°C	120°C/72°C	All temperature ranges
h _{ef} [mm]		N _{Rk,b} = N _{Rk,p} ¹⁾			V _{Rk,b} ²⁾³⁾	
[kN]						
Compressive strength f_b ≥ 10 N/mm²						
M8	-	80	3,5 (1,5)	3,5 (1,5)	2,5 (1,2)	3,5 (1,2)
M10 / IG-M6	-	90	3,5 (1,5)	3,5 (1,5)	3,0 (1,5)	3,5 (1,2)
M12 / IG-M8	-	100	4,0 (2,0)	4,0 (2,0)	3,5 (1,5)	3,5 (1,2)
M16 / IG-M10	-	100	4,0 (2,0)	4,0 (2,0)	3,5 (1,5)	5,5 (1,5)
M8	12x80	80	3,5 (1,5)	3,5 (1,5)	3,0 (1,2)	3,5 (1,2)
M8 / M10 / IG-M6	16x85	85	3,5 (1,5)	3,5 (1,5)	3,0 (1,5)	3,5 (1,2)
	16x130	130				
M12 / M16 / IG-M8 / IG-M10	20x85	85				
	20x130	130				
	20x200	200				
Compressive strength f_b ≥ 20 N/mm²						
M8	-	80	4,5 (2,5)	4,5 (2,5)	4,0 (2,0)	5,0 (1,5)
M10 / IG-M6	-	90	5,5 (2,5)	5,5 (2,5)	4,5 (2,0)	5,0 (1,5)
M12 / IG-M8	-	100	6,0 (3,0)	6,0 (3,0)	5,0 (2,5)	5,0 (1,5)
M16 / IG-M10	-	100	6,0 (3,0)	6,0 (3,0)	5,0 (2,5)	8,0 (2,5)
M8	12x80	80	4,5 (2,5)	4,5 (2,5)	4,0 (2,0)	5,0 (1,5)
M8 / M10 / IG-M6	16x85	85	5,0 (2,5)	5,0 (2,5)	4,0 (2,0)	5,0 (1,5)
	16x130	130				
M12 / M16 / IG-M8 / IG-M10	20x85	85				
	20x130	130				
	20x200	200				
Compressive strength f_b ≥ 28 N/mm²						
M8	-	80	5,5 (2,5)	5,5 (2,5)	4,5 (2,5)	5,5 (2,0)
M10 / IG-M6	-	90	6,0 (3,0)	6,0 (3,0)	5,0 (2,5)	5,5 (2,0)
M12 / IG-M8	-	100	7,0 (3,5)	7,0 (3,5)	6,0 (3,0)	5,5 (2,0)
M16 / IG-M10	-	100	7,0 (3,5)	7,0 (3,5)	6,0 (3,0)	9,0 (3,0)
M8	12x80	80	5,5 (2,5)	5,5 (2,5)	4,5 (2,5)	5,5 (2,0)
M8 / M10 / IG-M6	16x85	85	6,0 (3,0)	6,0 (3,0)	5,0 (2,5)	5,5 (2,0)
	16x130	130				
M12 / M16 / IG-M8 / IG-M10	20x85	85				
	20x130	130				
	20x200	200				

1) Values are valid for c_{cr}, values in brackets are valid for single anchors with c_{min}

2) For c_{cr} calculation of V_{Rk,c} see ETAG 029, Annex C; for c_{min} values in brackets V_{Rk,c} = V_{Rk,b}

3) The values are valid for steel 5.6 or higher. For steel 4.6 and 4.8 multiply V_{Rk,b} by 0,8.

Injection System VMU plus for masonry

Performance - Clay solid brick Mz-DF
Characteristic values of resistance

Annex C16

Brick type: Clay solid brick Mz-DF

Table C40: Displacements

Anchor size	Sleeve	h_{ef}	N	δ_N / N	δ_{N0}	$\delta_{N\infty}$	V	δ_{v0}	$\delta_{v\infty}$
		[mm]	[kN]	[mm/kN]	[mm]	[mm]	[kN]	[mm]	[mm]
M8	-	80	1,3	0,15	0,19	0,39	1,9	1,00	1,50
M10 / IG-M6	-	90	1,6		0,24	0,47			
M12 / IG-M8	-	100	1,7		0,26	0,51			
M16 / IG-M10	-	100							
M8	12x80	80	1,3	0,15	0,19	0,39	1,9	1,00	1,50
M8 / M10 / IG-M6	16x85	85							
	16x130	130							
M12 / M16 / IG-M8 / IG-M10	20x85	85							
	20x130	130							
	20x200	200							

Injection System VMU plus for masonry

Performance - Clay solid brick Mz-DF
Displacements

Annex C17

Brick type: Clay hollow brick HLz-16-DF

Table C41: Description of the brick

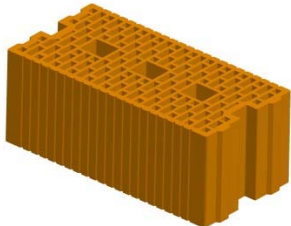
Brick type	Clay hollow brick HLz-16-DF		
Bulk density ρ [kg/dm ³]		0,8	
Compressive strength $f_b \geq$ [N/mm ²]		6, 8, 12 or 14	
Code		EN 771-1	
Producer (country code)		e.g. Unipor (DE)	
Brick dimensions [mm]		497 x 240 x 238	
Drilling method		Rotary	

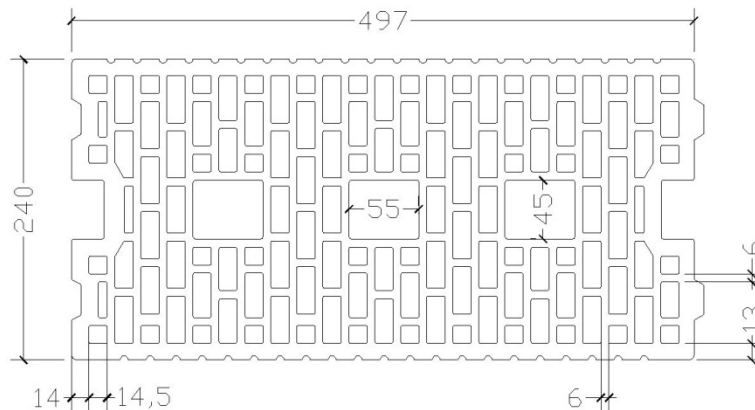

Table C42: Spacing and edge distances

Anchor size			All sizes
Edge distance	C_{cr}	[mm]	100 (120) ¹⁾
Minimum edge distance	$C_{min}^{2)}$	[mm]	100 (120) ¹⁾
Spacing	$S_{cr, }$	[mm]	497
	$S_{cr,\perp}$	[mm]	238
Minimum spacing	S_{min}	[mm]	100

¹⁾ Value in bracket for VM-SH 20x85; VM-SH 20x130 and VM-SH 20x200

²⁾ For $V_{Rk,c}$: C_{min} according to ETAG 029, Annex C

Table C43: Group factor for anchor group in case of tension loading

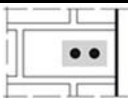
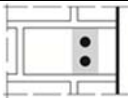
Configuration		with c [mm] \geq	with s [mm] \geq			
: anchors placed parallel to horizontal joint		C_{cr}	100	$\alpha_{g,N, }$	[-]	1,3
		C_{cr}	497			2,0
⊥: anchors placed perpendicular to horizontal joint		C_{cr}	100	$\alpha_{g,N,\perp}$	[-]	1,1
		C_{cr}	238			2,0

Injection System VMU plus for masonry

Performance - Clay hollow brick HLz-16DF

Description of the brick, Spacing and edge distances, Group factor

Annex C18

Brick type: Clay hollow brick HLz-16-DF

Table C44: Group factor for anchor group in case of shear loading parallel to free edge

Configuration		with c [mm] ≥	with s [mm] ≥			
: anchors placed parallel to horizontal joint		C_{cr}	497	$\alpha_{g,V, }$	[-]	2,0
⊥: anchors placed perpendicular to horizontal joint		C_{cr}	238	$\alpha_{g,V,\perp}$		2,0

Table C45: Group factor for anchor group in case of shear load perpendicular to free edge

Configuration		with c [mm] ≥	with s [mm] ≥			
: anchors placed parallel to horizontal joint		C_{cr}	497	$\alpha_{g,V, }$	[-]	2,0
⊥: anchors placed perpendicular to horizontal joint		C_{cr}	238	$\alpha_{g,V,\perp}$		2,0

Table C46: Characteristic values of resistance under tension and shear loads

Anchor size	Sleeve	Effective Anchorage depth	Characteristic resistance			
			Use category			
			d/d w/d w/w			d/d w/d w/w
			40°C/24°C	80°C/50°C	120°C/72°C	All temperature ranges
h_{ef}	$N_{Rk,b} = N_{Rk,p}^{1)}$			$V_{Rk,b}^{2)3)}$		
[mm]	[kN]			[kN]		
Compressive strength $f_b \geq 6 \text{ N/mm}^2$						
M8	12x80	80	2,5	2,5	2,0	2,5
M8 / M10/ IG-M6	16x85	85	2,5	2,5	2,0	4,5
	16x130	130	3,5	3,5	3,0	4,5
M12 / M16 / IG-M8 / IG-M10	20x85	85	2,5	2,5	2,0	5,0
	20x130	130	3,5	3,5	3,0	6,0
	20x200	200	3,5	3,5	3,0	6,0
Compressive strength $f_b \geq 8 \text{ N/mm}^2$						
M8	12x80	80	3,0	3,0	2,5	3,0
M8 / M10/ IG-M6	16x85	85	3,0	3,0	2,5	5,5
	16x130	130	4,5	4,5	3,5	5,5
M12 / M16 / IG-M8 / IG-M10	20x85	85	3,0	3,0	2,5	6,0
	20x130	130	4,5	4,5	3,5	7,0
	20x200	200	4,5	4,5	3,5	7,0

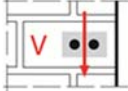
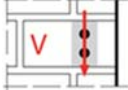
1) Values are valid for c_{cr} and c_{min}

2) Calculation of $V_{Rk,c}$ see ETAG 029, Annex C, except for shear load parallel to free edge with $c \geq 125 \text{ mm}$: $V_{Rk,c,||} = V_{Rk,b}$

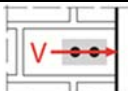
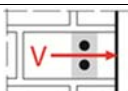
3) The values are valid for steel 5.6 or higher. For steel 4.6 and 4.8 multiply $V_{Rk,b}$ by 0,8

Injection System VMU plus for masonry

Performance - Clay hollow brick HLz-16DF
Group factor, Characteristic values of resistance

Annex C19

Brick type: Clay hollow brick HLz-16DF

Table C47: Characteristic values of resistance under tension and shear loads (continue)

Anchor size	Sleeve	Effective Anchorage depth	Characteristic resistance			
			Use category			
			d/d w/d w/w			d/d w/d w/w
			40°C/24°C	80°C/50°C	120°C/72°C	All temperature ranges
h_{ef} [mm]	$N_{Rk,b} = N_{Rk,p}^{1)}$ [kN]			$V_{Rk,b}^{2)3)}$ [kN]		
Compressive strength $f_b \geq 12 \text{ N/mm}^2$						
M8	12x80	80	3,5	3,5	3,0	4,0
M8 / M10/ IG-M6	16x85	85	3,5	3,5	3,0	6,5
	16x130	130	5,0	5,0	4,5	6,5
M12 / M16 / IG-M8 / IG-M10	20x85	85	3,5	3,5	3,0	7,0
	20x130	130	5,0	5,0	4,5	9,0
	20x200	200	5,0	5,0	4,5	9,0
Compressive strength $f_b \geq 14 \text{ N/mm}^2$						
M8	12x80	80	4,0	4,0	3,0	4,0
M8 / M10/ IG-M6	16x85	85	4,0	4,0	3,0	6,5
	16x130	130	5,5	5,5	4,5	6,5
M12 / M16 / IG-M8 / IG-M10	20x85	85	4,0	4,0	3,0	7,0
	20x130	130	5,5	5,5	4,5	9,0
	20x200	200	5,5	5,5	4,5	9,0

1) Values are valid for c_{cr} and c_{min}

2) Calculation of $V_{Rk,c}$ see ETAG 029, Annex C, except for shear load parallel to free edge with $c \geq 125 \text{ mm}$: $V_{Rk,c,II} = V_{Rk,b}$

3) The values are valid for steel 5.6 or higher. For steel 4.6 and 4.8 multiply $V_{Rk,b}$ by 0,8

Table C48: Displacements

Anchor size	Sleeve	h_{ef}	N	δ_N / N	δ_{N0}	$\delta_{N\infty}$	V	δ_{V0}	$\delta_{V\infty}$
		[mm]	[kN]	[mm/kN]	[mm]	[mm]	[kN]	[mm]	[mm]
M8	12x80	80	1,14	0,10	0,11	0,23	1,10	1,20	1,80
M8 / M10/ IG-M6	16x85	85							
	16x130	130	1,57						
M12 / M16 / IG-M8 / IG-M10	20x85	85	1,14		0,11	0,23	1,86	1,50	2,25
	20x130	130	1,57		0,16	0,31	2,57	2,10	3,15
	20x200	200							

Injection System VMU plus for masonry

Performance - Clay hollow brick HLz-16DF
Characteristic values of resistance (continue), Displacements

Annex C20

Brick type: Clay hollow brick Porotherm Homebric

Table C49: Description of the brick

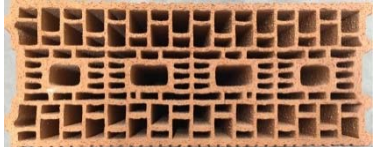
Brick type	Clay hollow brick Porotherm Homebric		
Bulk density ρ [kg/dm ³]	0,7		
Compressive strength $f_b \geq$ [N/mm ²]	4, 6 or 10		
Code	EN 771-1		
Producer (country code)	e.g. Wienerberger (FR)		
Brick dimensions [mm]	500 x 200 x 299		
Drilling method	Rotary		

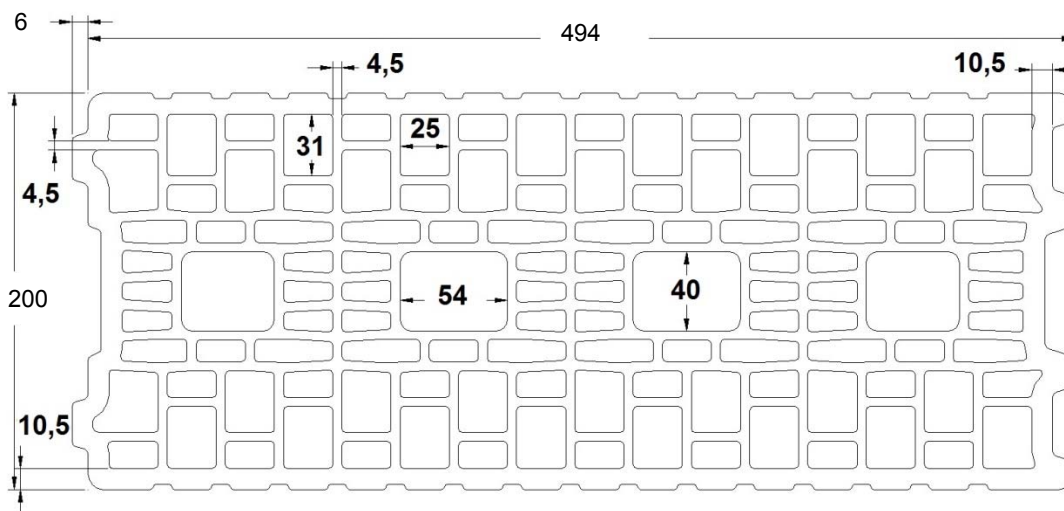

Table C50: Spacing and edge distances

Anchor size		All sizes	
Edge distance	C_{cr} [mm]	100 (120) ¹⁾	
Minimum edge distance	$C_{min}^{2)}$ [mm]	100 (120) ¹⁾	
Spacing	$S_{cr, }$ [mm]	500	
	$S_{cr,\perp}$ [mm]	299	
Minimum spacing	S_{min} [mm]	100	

1) Value in brackets for VM-SH 20x85 and VM-SH 20x130

2) For $V_{Rk,c}$: C_{min} according to ETAG 029, Annex C

Table C51: Group factor for anchor group in case of tension loading

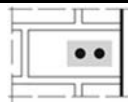
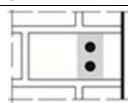
Configuration		with c [mm] \geq	with s [mm] \geq			
II: anchors placed parallel to horizontal joint		200	100	$\alpha_{g,N, }$	[-]	2,0
		C_{cr}	500			2,0
⊥: anchors placed perpendicular to horizontal joint		200	100	$\alpha_{g,N,\perp}$	[-]	1,2
		C_{cr}	299			2,0

Injection System VMU plus for masonry

Performance - Clay hollow brick Porotherm Homebric
Description of the brick, Spacing and edge distances, Group factor

Annex C21

Brick type: Clay hollow brick Porotherm Homebric

Table C52: Group factor for anchor group in case of shear loading parallel to free edge

Configuration		with c [mm] ≥	with s [mm] ≥			
II: anchors placed parallel to horizontal joint		C_{cr}	500	$\alpha_{g,V,II}$	[-]	2,0
I: anchors placed perpendicular to horizontal joint		C_{cr}	299	$\alpha_{g,V,I}$		2,0

Table C53: Group factor for anchor group in case of shear load perpendicular to free edge

Configuration		with c [mm] ≥	with s [mm] ≥			
II: anchors placed parallel to horizontal joint		C_{cr}	500	$\alpha_{g,V,II}$	[-]	2,0
I: anchors placed perpendicular to horizontal joint		C_{cr}	299	$\alpha_{g,V,I}$		2,0

Table C54: Characteristic values of resistance under tension and shear loads

Anchor size	Sleeve	Effective Anchorage depth	Characteristic resistance			
			Use category			
			d/d w/d w/w			d/d w/d w/w
			40°C/24°C	80°C/50°C	120°C/72°C	All temperature ranges
h_{ef}	$N_{Rk,b} = N_{Rk,p}^{1)}$			$V_{Rk,b}^{2)3)}$		
[mm]	[kN]			[kN]		
Compressive strength $f_b \geq 4 \text{ N/mm}^2$						
M8	12x80	80	0,9	0,9	0,75	2,0
M8 / M10 / IG-M6	16x85	85	0,9	0,9	0,75	2,0
	16x130	130	1,2	1,2	0,9	2,0
M12 / M16 / IG-M8 / IG-M10	20x85	85	0,9	0,9	0,75	2,5
	20x130	130	1,2	1,2	0,9	2,5
Compressive strength $f_b \geq 6 \text{ N/mm}^2$						
M8	12x80	80	0,9	0,9	0,9	2,5
M8 / M10 / IG-M6	16x85	85	0,9	0,9	0,9	2,5
	16x130	130	1,2	1,2	1,2	2,5
M12 / M16 / IG-M8 / IG-M10	20x85	85	0,9	0,9	0,9	3,0
	20x130	130	1,2	1,2	1,2	3,0

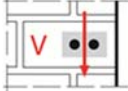
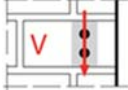
1) Values are valid for c_{cr} and c_{min}

2) Calculation of $V_{Rk,c}$ see ETAG 029, Annex C, except for shear load parallel to free edge with $c \geq 200 \text{ mm}$: $V_{Rk,c,II} = V_{Rk,b}$

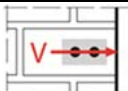
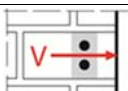
3) The values are valid for steel 5.6 or higher. For steel 4.6 and 4.8 multiply $V_{Rk,b}$ by 0,8

Injection System VMU plus for masonry

Performance - Clay hollow brick Porotherm Homebric
Group factor, Characteristic values of resistance

Annex C22

Brick type: Clay hollow brick Porotherm Homebric

Table C55: Characteristic values of resistance under tension and shear loads (continue)

Anchor size	Sleeve	Effective Anchorage depth	Characteristic resistance			
			Use category			
			d/d w/d w/w			d/d w/d w/w
			40°C/24°C	80°C/50°C	120°C/72°C	All temperature ranges
h_{ef}	$N_{Rk,b} = N_{Rk,p}^{1)}$			$V_{Rk,b}^{2)3)}$		
[mm]	[kN]			[kN]		
Compressive strength $f_b \geq 10 \text{ N/mm}^2$						
M8	12x80	80	1,2	1,2	1,2	3,0
M8 / M10/ IG-M6	16x85	85	1,2	1,2	1,2	3,0
	16x130	130	1,5	1,5	1,5	3,5
M12 / M16 / IG-M8 / IG-M10	20x85	85	1,2	1,2	1,2	4,0
	20x130	130	1,5	1,5	1,5	4,0

1) Values are valid for c_{cr} and c_{min}

2) Calculation of $V_{Rk,c}$ see ETAG 029, Annex C, except for shear load parallel to free edge with $c \geq 200 \text{ mm}$: $V_{Rk,c,II} = V_{Rk,b}$

3) The values are valid for steel 5.6 or higher. For steel 4.6 and 4.8 multiply $V_{Rk,b}$ by 0,8

Table C56: Displacements

Anchor size	Sleeve	h_{ef}	N	δ_N / N	δ_{N0}	$\delta_{N\infty}$	V	δ_{v0}	$\delta_{v\infty}$
		[mm]	[kN]	[mm/kN]	[mm]	[mm]	[kN]	[mm]	[mm]
M8	12x80	80	0,34	0,80	0,27	0,55	0,9	1,20	1,80
M8 / M10/ IG-M6	16x85	85					0,9		
	16x130	130	0,43		0,34	0,69	1,0		
M12 / M16 / IG-M8 / IG-M10	20x85	85	0,34		0,27	0,55	1,14		
	20x130	130	0,43	0,34	0,69				

Injection System VMU plus for masonry

Performance - Clay hollow brick Porotherm Homebric
Characteristic values of resistance (continue), Displacements

Annex C23

Brick type: Clay hollow brick BGV Thermo

Table C57: Description of the brick

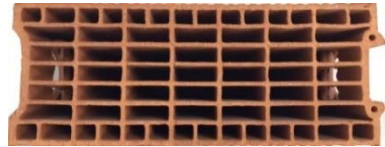
Brick type	Clay hollow brick BGV Thermo		
Bulk density	ρ [kg/dm ³]	0,6	
Compressive strength	$f_b \geq$ [N/mm ²]	4, 6 or 10	
Code	EN 771-1		
Producer (country code)	e.g. Leroux (FR)		
Brick dimensions	[mm]	500 x 200 x 314	
Drilling method	Rotary		

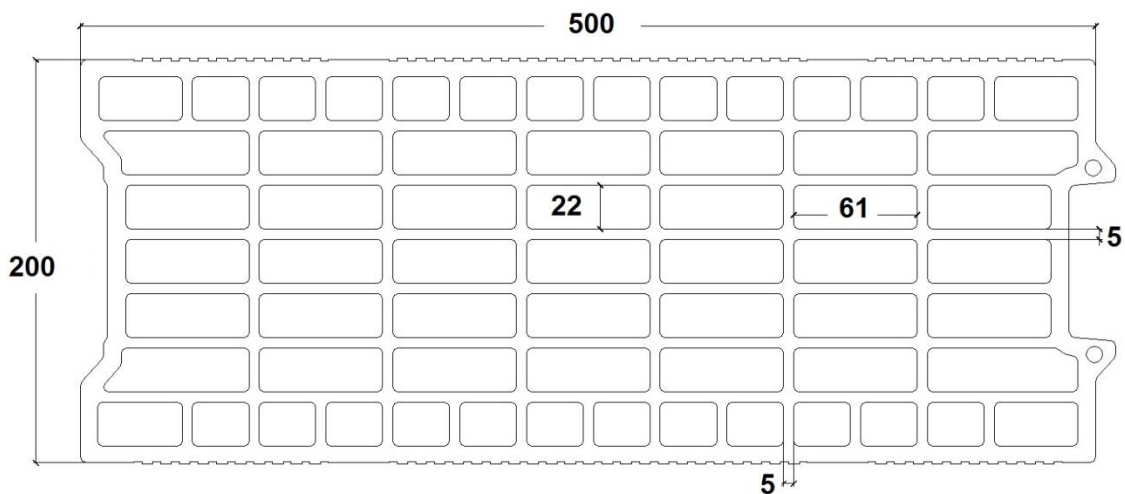

Table C58: Spacing and edge distances

Anchor size			All sizes
Edge distance	C_{cr}	[mm]	100 (120) ¹⁾
Minimum edge distance	C_{min} ²⁾	[mm]	100 (120) ¹⁾
Spacing	$S_{cr, }$	[mm]	500
	$S_{cr,\perp}$	[mm]	314
Minimum spacing	S_{min}	[mm]	100

¹⁾ Values in brackets for VM-SH 20x85 and VM-SH 20x130

²⁾ For $V_{Rk,c}$: C_{min} according to ETAG 029, Annex C

Table C59: Group factor for anchor group in case of tension loading

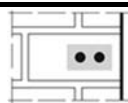
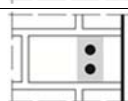
Configuration		with c [mm] \geq	with s [mm] \geq			
: anchors placed parallel to horizontal joint		200	100	$\alpha_{g,N, }$	[-]	1,7
		C_{cr}	500			2,0
\perp : anchors placed perpendicular to horizontal joint		200	100	$\alpha_{g,N,\perp}$	[-]	1,1
		C_{cr}	314			2,0

Injection System VMU plus for masonry

Performance - Clay hollow brick BGV Thermo

Description of the brick, Spacing and edge distances, Group factor

Annex C24

Brick type: Clay hollow brick BGV Thermo

Table C60: Group factor for anchor group in case of shear loading parallel to free edge

Configuration		with c [mm] \geq	with s [mm] \geq			
: anchors placed parallel to horizontal joint		C_{cr}	500	$\alpha_{g,V, }$	[-]	2,0
⊥: anchors placed perpendicular to horizontal joint		C_{cr}	314	$\alpha_{g,V,\perp}$		2,0

Table C61: Group factor for anchor group in case of shear load perpendicular to free edge

Configuration		with c [mm] \geq	with s [mm] \geq			
: anchors placed parallel to horizontal joint		C_{cr}	500	$\alpha_{g,V, }$	[-]	2,0
⊥: anchors placed perpendicular to horizontal joint		C_{cr}	314	$\alpha_{g,V,\perp}$		2,0

Injection System VMU plus for masonry

Performance - Clay hollow brick BGV Thermo
Group factor

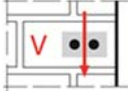
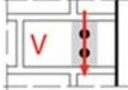
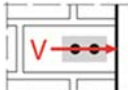
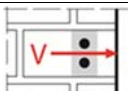
Annex C25

Brick type: Clay hollow brick BGV Thermo

Table C62: Characteristic values of resistance under tension and shear loads

Anchor size	Sleeve	Effective Anchorage depth	Characteristic resistance			
			Use category			
			d/d w/d w/w			d/d w/d w/w
			40°C/24°C	80°C/50°C	120°C/72°C	All temperature ranges
h_{ef} [mm]	$N_{Rk,b} = N_{Rk,p}^{1)}$ [kN]			$V_{Rk,b}^{2)3)}$ [kN]		
Compressive strength $f_b \geq 4 \text{ N/mm}^2$						
M8	12x80	80	0,6	0,6	0,6	2,0
M8 / M10/ IG-M6	16x85	85	0,6	0,6	0,6	2,0
	16x130	130	1,2	1,2	0,9	2,5
M12 / M16 / IG-M8 / IG-M10	20x85	85	0,6	0,6	0,6	2,5
	20x130	130	1,2	1,2	0,9	2,5
Compressive strength $f_b \geq 6 \text{ N/mm}^2$						
M8	12x80	80	0,9	0,9	0,75	2,5
M8 / M10/ IG-M6	16x85	85	0,9	0,9	0,75	2,5
	16x130	130	1,5	1,5	1,2	3,0
M12 / M16 / IG-M8 / IG-M10	20x85	85	0,9	0,9	0,75	3,0
	20x130	130	1,5	1,5	1,2	3,0
Compressive strength $f_b \geq 10 \text{ N/mm}^2$						
M8	12x80	80	0,9	0,9	0,9	3,5
M8 / M10/ IG-M6	16x85	85	0,9	0,9	0,9	3,5
	16x130	130	2,0	2,0	1,5	4,0
M12 / M16 / IG-M8 / IG-M10	20x85	85	0,9	0,9	0,9	4,0
	20x130	130	2,0	2,0	1,5	4,0

1) Values are valid for c_{cr} and c_{min}

2) Calculation of $V_{Rk,c}$ see ETAG 029, Annex C, except for shear load parallel to free edge with $c \geq 250 \text{ mm}$: $V_{Rk,c,II} = V_{Rk,b}$

3) The values are valid for steel 5.6 or higher. For steel 4.6 and 4.8 multiply $V_{Rk,b}$ by 0,8

Table C63: Displacements

Anchor size	Sleeve	h_{ef}	N	δ_N / N	δ_{N0}	$\delta_{N\infty}$	V	δ_{v0}	$\delta_{v\infty}$
		[mm]	[kN]	[mm/kN]	[mm]	[mm]	[kN]	[mm]	[mm]
M8	12x80	80	0,26	0,80	0,21	0,41	0,7	1,00	1,50
M8 / M10/ IG-M6	16x85	85							
	16x130	130	0,43		0,34	0,69			
M12 / M16 / IG-M8 / IG-M10	20x85	85	0,26		0,21	0,41	0,86		
	20x130	130	0,43	0,34	0,69				

Injection System VMU plus for masonry

Performance - Clay hollow brick BGV Thermo
Characteristic values of resistance, Displacements

Annex C26

Brick type: Clay hollow brick Calibric R+

Table C64: Description of the brick

Brick type	Clay hollow brick Calibric R+		
Bulk density ρ [kg/dm ³]	0,6		
Compressive strength $f_b \geq$ [N/mm ²]	6, 9 or 12		
Code	EN 771-1		
Producer (country code)	e.g. Terreal (FR)		
Brick dimensions [mm]	500 x 200 x 314		
Drilling method	Rotary		

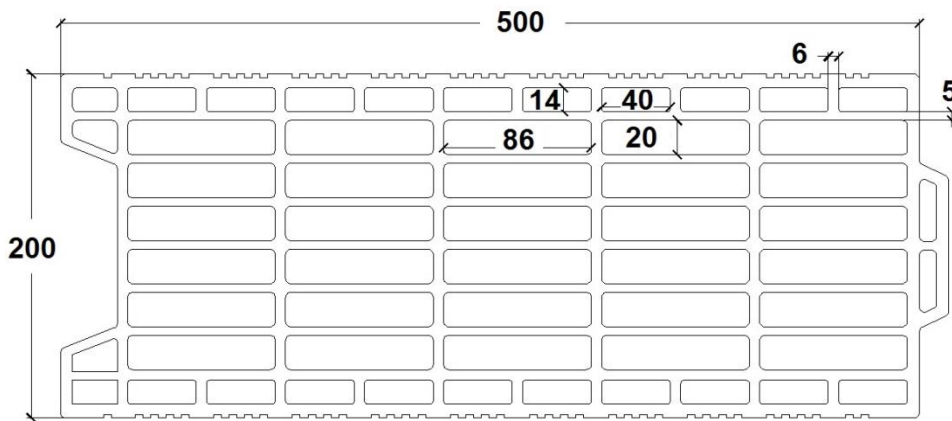

Table C65: Spacing and edge distances

Anchor size			All sizes
Edge distance	C_{cr}	[mm]	100 (120) ¹⁾
Minimum edge distance	$C_{min}^{2)}$	[mm]	100 (120) ¹⁾
Spacing	$S_{cr,II}$	[mm]	500
	$S_{cr,\perp}$	[mm]	314
Minimum spacing	S_{min}	[mm]	100

¹⁾ Value in brackets for VM-SH 20x85 and VM-SH 20x130

²⁾ For $V_{Rk,c}$: C_{min} according to ETAG 029, Annex C

Table C66: Group factor for anchor group in case of tension loading

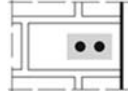
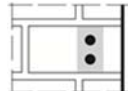
Configuration		with c [mm] \geq	with s [mm] \geq			
II: anchors placed parallel to horizontal joint		175	100	$\alpha_{g,N,II}$	[-]	1,7
		C_{cr}	500			2,0
\perp : anchors placed perpendicular to horizontal joint		175	100	$\alpha_{g,N,\perp}$		1,0
		C_{cr}	314			2,0

Injection System VMU plus for masonry

Performance - Clay hollow brick Calibric R+

Description of the brick, Spacing and edge distances, Group factor

Annex C27

Brick type: Clay hollow brick Calibric R+

Table C67: Group factor for anchor group in case of shear loading parallel to free edge

Configuration		with c [mm] ≥	with s [mm] ≥			
II: anchors placed parallel to horizontal joint		C_{cr}	500	$\alpha_{g,V,II}$	[-]	2,0
I: anchors placed perpendicular to horizontal joint		C_{cr}	314	$\alpha_{g,V,I}$		2,0

Table C68: Group factor for anchor group in case of shear load perpendicular to free edge

Configuration		with c [mm] ≥	with s [mm] ≥			
II: anchors placed parallel to horizontal joint		C_{cr}	500	$\alpha_{g,V,II}$	[-]	2,0
I: anchors placed perpendicular to horizontal joint		C_{cr}	314	$\alpha_{g,V,I}$		2,0

Table C69: Characteristic values of resistance under tension and shear loads

Anchor size	Sleeve	Effective Anchorage depth	Characteristic resistance			
			Use category			
			d/d w/d w/w			d/d w/d w/w
			40°C/24°C	80°C/50°C	120°C/72°C	All temperature ranges
		h_{ef}	$N_{Rk,b} = N_{Rk,p}^{1)}$			$V_{Rk,b}^{2)3)}$
		[mm]	[kN]			[kN]
Compressive strength $f_b \geq 6 \text{ N/mm}^2$						
M8	12x80	80	0,9	0,9	0,75	3,0
M8 / M10/ IG-M6	16x85	85	0,9	0,9	0,75	4,0
	16x130	130	1,2	1,2	0,9	4,0
M12 / M16 / IG-M8 / IG-M10	20x85	85	0,9	0,9	0,75	6,0
	20x130	130	1,2	1,2	0,9	6,0
Compressive strength $f_b \geq 9 \text{ N/mm}^2$						
M8	12x80	80	1,2	1,2	0,9	3,5
M8 / M10/ IG-M6	16x85	85	1,2	1,2	0,9	5,0
	16x130	130	1,5	1,5	1,2	5,0
M12 / M16 / IG-M8 / IG-M10	20x85	85	1,2	1,2	0,9	7,5
	20x130	130	1,5	1,5	1,2	7,5

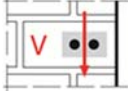
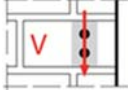
1) Values are valid for c_{cr} and c_{min}

2) Calculation of $V_{Rk,c}$ see ETAG 029, Annex C, except for shear load parallel to free edge with $c \geq 250 \text{ mm}$: $V_{Rk,c,II} = V_{Rk,b}$

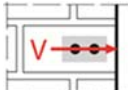
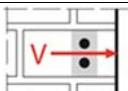
3) The values are valid for steel 5.6 or higher. For steel 4.6 and 4.8 multiply $V_{Rk,b}$ by 0,8

Injection System VMU plus for masonry

Performance - Clay hollow brick Calibric R+
Group factor, Characteristic values of resistance

Annex C28

Brick type: Clay hollow brick Calibric R+

Table C70: Characteristic values of resistance under tension and shear load (continue)

Anchor size	Sleeve	Effective Anchorage depth	Characteristic resistance			
			Use category			
			d/d w/d w/w			d/d w/d w/w
			40°C/24°C	80°C/50°C	120°C/72°C	All temperature ranges
h_{ef}	$N_{Rk,b} = N_{Rk,p}^{1)}$			$V_{Rk,b}^{2)3)}$		
[mm]	[kN]			[kN]		
Compressive strength $f_b \geq 12 \text{ N/mm}^2$						
M8	12x80	80	1,2	1,2	0,9	4,0
M8 / M10/ IG-M6	16x85	85	1,2	1,2	0,9	5,5
	16x130	130	1,5	1,5	1,2	5,5
M12 / M16 / IG-M8 / IG-M10	20x85	85	1,2	1,2	0,9	8,5
	20x130	130	1,5	1,5	1,2	8,5

1) Values are valid for c_{cr} and c_{min}

2) Calculation of $V_{Rk,c}$ see ETAG 029, Annex C, except for shear load parallel to free edge with $c \geq 250 \text{ mm}$: $V_{Rk,c,II} = V_{Rk,b}$

3) The values are valid for steel 5.6 or higher. For steel 4.6 and 4.8 multiply $V_{Rk,b}$ by 0,8

Table C71: Displacements

Anchor size	Sleeve	h_{ef}	N	δ_N / N	δ_{N0}	$\delta_{N\infty}$	V	δ_{v0}	$\delta_{v\infty}$
		[mm]	[kN]	[mm/kN]	[mm]	[mm]	[kN]	[mm]	[mm]
M8	12x80	80	0,34	0,80	0,27	0,55	1,0	1,10	1,65
M8 / M10/ IG-M6	16x85	85							
	16x130	130	0,43		0,34	0,69	1,43	2,0	
M12 / M16 / IG-M8 / IG-M10	20x85	85	0,34		0,27	0,55	2,14		
	20x130	130	0,43		0,34	0,69			

Injection System VMU plus for masonry

Performance - Clay hollow brick Calibric R+
Characteristic values of resistance, Displacements

Annex C29

Brick type: Clay hollow brick Urbanbric

Table C72: Description of the brick

Brick type	Clay hollow brick Urbanbric		
Bulk density ρ [kg/dm ³]		0,7	
Compressive strength $f_b \geq$ [N/mm ²]		6, 9 or 12	
Code		EN 771-1	
Producer (country code)		e.g. Imerys (FR)	
Brick dimensions [mm]		560 x 200 x 274	
Drilling method		Rotary	

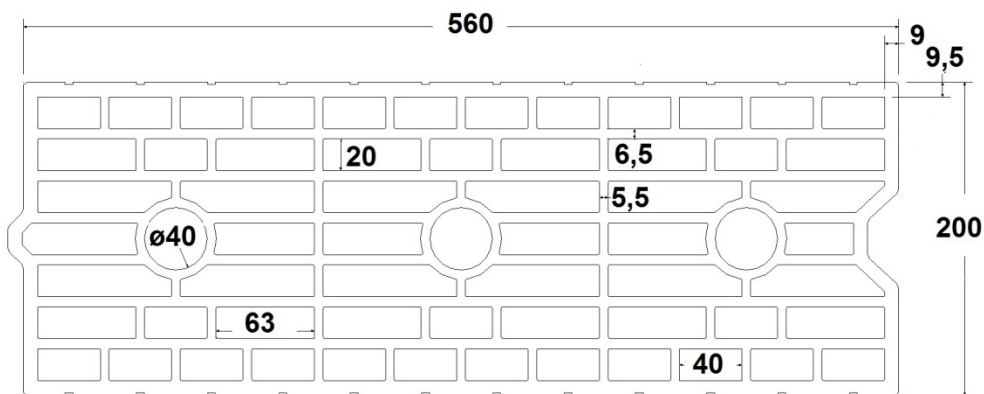

Table C73: Spacing and edge distances

Anchor size			All sizes
Edge distance	C_{cr}	[mm]	100 (120) ¹⁾
Minimum edge distance	$C_{min}^{2)}$	[mm]	100 (120) ¹⁾
Spacing	$S_{cr,II}$	[mm]	560
	$S_{cr,\perp}$	[mm]	274
Minimum spacing	S_{min}	[mm]	100

1) Value in brackets for VM-SH 20x85 and VM-SH 20x130

2) For $V_{Rk,c}$: c_{min} according to ETAG 029, Annex C

Table C74: Group factor for anchor group in case of tension loading

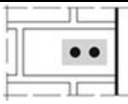
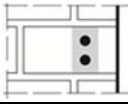
Configuration		with c [mm] \geq	with s [mm] \geq			
II: anchors placed parallel to horizontal joint		185	100	$\alpha_{g,N,II}$	[-]	1,9
		C_{cr}	560			2,0
⊥: anchors placed perpendicular to horizontal joint		185	100	$\alpha_{g,N,\perp}$		1,1
		C_{cr}	274			2,0

Injection System VMU plus for masonry

Performance - Clay hollow brick Urbanbric

Description of the brick, Spacing and edge distances, Group factor

Annex C30

Brick type: Clay hollow brick Urbanbric

Table C75: Group factor for anchor group in case of shear loading parallel to free edge

Configuration		with c [mm] ≥	with s [mm] ≥			
: anchors placed parallel to horizontal joint		C_{cr}	560	$\alpha_{g,V, }$	[-]	2,0
⊥: anchors placed perpendicular to horizontal joint		C_{cr}	274	$\alpha_{g,V,\perp}$		2,0

Table C76: Group factor for anchor groups in case of shear load perpendicular to free edge

Configuration		with c [mm] ≥	with s [mm] ≥			
: anchors placed parallel to horizontal joint		C_{cr}	560	$\alpha_{g,V, }$	[-]	2,0
⊥: anchors placed perpendicular to horizontal joint		C_{cr}	274	$\alpha_{g,V,\perp}$		2,0

Table C77: Characteristic values of resistance under tension and shear load

Anchor size	Sleeve	Effective Anchorage depth	Characteristic resistance			
			Use category			
			d/d w/d w/w			d/d w/d w/w
			40°C/24°C	80°C/50°C	120°C/72°C	All temperature ranges
h_{ef}	$N_{Rk,b} = N_{Rk,p}^{1)}$			$V_{Rk,b}^{2)3)}$		
[mm]	[kN]			[kN]		
Compressive strength $f_b \geq 6 \text{ N/mm}^2$						
M8	12x80	80	0,9	0,9	0,75	3,0
M8 / M10/ IG-M6	16x85	85	0,9	0,9	0,75	3,0
	16x130	130	2,0	2,0	1,5	3,0
M12 / M16 / IG-M8 / IG-M10	20x85	85	0,9	0,9	0,75	3,5
	20x130	130	2,0	2,0	1,5	3,5
Compressive strength $f_b \geq 9 \text{ N/mm}^2$						
M8	12x80	80	0,9	0,9	0,9	4,0
M8 / M10/ IG-M6	16x85	85	0,9	0,9	0,9	4,0
	16x130	130	2,5	2,5	2,0	4,0
M12 / M16 / IG-M8 / IG-M10	20x85	85	0,9	0,9	0,9	4,5
	20x130	130	2,5	2,5	2,0	4,5

1) Values are valid for c_{cr} and c_{min}

2) Calculation of $V_{Rk,c}$ see ETAG 029, Annex C, except for shear load parallel to free edge with $c \geq 190 \text{ mm}$: $V_{Rk,c,||} = V_{Rk,b}$

3) The values are valid for steel 5.6 or higher. For steel 4.6 and 4.8 multiply $V_{Rk,b}$ by 0,8

Injection System VMU plus for masonry

Performance - Clay hollow brick Urbanbric
Group factor, Characteristic values of resistance

Annex C31

Brick type: Clay hollow brick Urbanbric

Table C78: Characteristic values of resistance under tension and shear load (continue)

Anchor size	Sleeve	Effective Anchorage depth	Characteristic resistance			
			Use category			
			d/d w/d w/w			d/d w/d w/w
			40°C/24°C	80°C/50°C	120°C/72°C	All temperature ranges
h _{ef}		N _{Rk,b} = N _{Rk,p} ¹⁾			V _{Rk,b} ²⁾³⁾	
[mm]		[kN]			[kN]	
Compressive strength f_b ≥ 12 N/mm²						
M8	12x80	80	1,2	1,2	0,9	4,5
M8 / M10/ IG-M6	16x85	85	1,2	1,2	0,9	4,5
	16x130	130	3,0	3,0	2,5	4,5
M12 / M16 / IG-M8 / IG-M10	20x85	85	1,2	1,2	0,9	5,0
	20x130	130	3,0	3,0	2,5	5,0

1) Values are valid for c_{cr} and c_{min}

2) Calculation of V_{Rk,c} see ETAG 029, Annex C, except for shear load parallel to free edge with c ≥ 190 mm: V_{Rk,c,II} = V_{Rk,b}

3) The values are valid for steel 5.6 or higher. For steel 4.6 and 4.8 multiply V_{Rk,b} by 0,8

Table C79: Displacements

Anchor size	Sleeve	h _{ef}	N	δ _N / N	δ _{N0}	δ _{N∞}	V	δ _{v0}	δ _{v∞}
		[mm]	[kN]	[mm/kN]	[mm]	[mm]	[kN]	[mm]	[mm]
M8	12x80	80	0,34	0,80	0,27	0,55	1,30	1,00	1,50
M8 / M10/ IG-M6	16x85	85							
	16x130	130	0,69		1,37				
M12 / M16 / IG-M8 / IG-M10	20x85	85	0,34		0,27	0,55	1,43		
	20x130	130	0,86	0,69	1,37				

Injection System VMU plus for masonry

Performance - Clay hollow brick Urbanbric
Characteristic values of resistance, Displacements

Annex C32

Brick type: Clay hollow brick Brique creuse C40

Table C80: Description of the brick

Brick type	Clay hollow brick Brique creuse C40		
Bulk density ρ [kg/dm ³]	0,7		
Compressive strength $f_b \geq$ [N/mm ²]	4, 8 or 12		
Code	EN 771-1		
Producer (country code)	e.g. Terreal (FR)		
Brick dimensions [mm]	500 x 200 x 200		
Drilling method	Rotary		

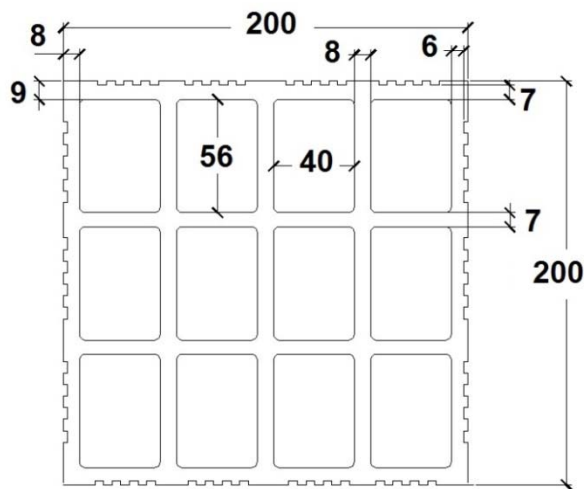

Table C81: Spacing and edge distances

Anchor size			All sizes
Edge distance	C_{cr}	[mm]	100 (120) ¹⁾
Minimum edge distance	$C_{min}^{2)}$	[mm]	100 (120) ¹⁾
Spacing	$S_{cr,II}$	[mm]	500
	$S_{cr,\perp}$	[mm]	200
Minimum spacing	S_{min}	[mm]	200

¹⁾ Values in brackets for VM-SH 20x85 and VM-SH 20x130

²⁾ For $V_{Rk,c}$: C_{min} according to ETAG 029, Annex C

Table C82: Group factor for anchor group in case of tension loading

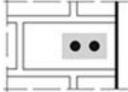
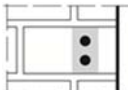
Configuration		with c [mm] \geq	with s [mm] \geq			
II: anchors placed parallel to horizontal joint		C_{cr}	200	$\alpha_{g,N,II}$	[-]	2,0
\perp : anchors placed perpendicular to horizontal joint		C_{cr}	200	$\alpha_{g,N,\perp}$		2,0

Injection System VMU plus for masonry

Performance - Clay hollow brick Brique creuse C40

Description of the brick, Spacing and edge distances, Group factor

Annex C33

Brick type: Clay hollow brick Brique creuse C40

Table C83: Group factor for anchor group in case of shear loading parallel to free edge

Configuration		with c [mm] ≥	with s [mm] ≥			
: anchors placed parallel to horizontal joint		c_{cr}	500	$\alpha_{g,V, }$	[-]	2,0
⊥: anchors placed perpendicular to horizontal joint		c_{cr}	200	$\alpha_{g,V,\perp}$		2,0

Table C84: Group factor for anchor group in case of shear load perpendicular to free edge

Configuration		with c [mm] ≥	with s [mm] ≥			
: anchors placed parallel to horizontal joint		c_{cr}	500	$\alpha_{g,V, }$	[-]	2,0
⊥: anchors placed perpendicular to horizontal joint		c_{cr}	200	$\alpha_{g,V,\perp}$		2,0

Table C85: Characteristic values of resistance under tension and shear load

Anchor size	Sleeve	Effective Anchorage depth	Characteristic resistance			
			Use category			
			d/d w/d w/w			d/d w/d w/w
			40°C/24°C	80°C/50°C	120°C/72°C	All temperature ranges
		h_{ef}	$N_{Rk,b} = N_{Rk,p}^{1)}$			$V_{Rk,b}^{2)3)}$
		[mm]	[kN]			[kN]
Compressive strength $f_b \geq 4 \text{ N/mm}^2$						
M8	12x80	80	0,6	0,6	0,6	0,9
M8 / M10/ IG-M6	16x85	85				
	16x130	130				
M12 / M16 / IG-M8 / IG-M10	20x85	85				
	20x130	130				
Compressive strength $f_b \geq 8 \text{ N/mm}^2$						
M8	12x80	80	0,9	0,9	0,75	1,2
M8 / M10/ IG-M6	16x85	85				
	16x130	130				
M12 / M16 / IG-M8 / IG-M10	20x85	85				
	20x130	130				

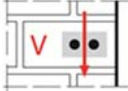
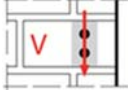
1) Values are valid for c_{cr} and c_{min}

2) Calculation of $V_{Rk,c}$ see ETAG 029, Annex C

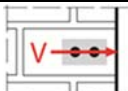
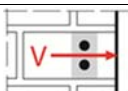
3) The values are valid for steel 5.6 or higher. For steel 4.6 and 4.8 multiply $V_{Rk,b}$ by 0,8

Injection System VMU plus for masonry

Annex C34

Performance - Clay hollow brick Brique creuse C40

Group factor, Characteristic values of resistance

Brick type: Clay hollow brick Brique creuse C40

Table C86: Characteristic values of resistance under tension and shear load (continue)

Anchor size	Sleeve	Effective Anchorage depth	Characteristic resistance			
			Use category			
			d/d w/d w/w			d/d w/d w/w
			40°C/24°C	80°C/50°C	120°C/72°C	All temperature ranges
h_{ef}	$N_{Rk,b} = N_{Rk,p}^{1)}$			$V_{Rk,b}^{2)3)}$		
[mm]	[kN]			[kN]		
Compressive strength $f_b \geq 12 \text{ N/mm}^2$						
M8	12x80	80	1,2	1,2	0,9	1,5
M8 / M10/ IG-M6	16x85	85				
	16x130	130				
M12 / M16 / IG-M8 / IG-M10	20x85	85				
	20x130	130				

1) Values are valid for c_{cr} and c_{min}

2) Calculation of $V_{Rk,c}$ see ETAG 029, Annex C

3) The values are valid for steel 5.6 or higher. For steel 4.6 and 4.8 multiply $V_{Rk,b}$ by 0,8

Table C87: Displacements

Anchor size	Sleeve	h_{ef}	N	δ_N / N	δ_{N0}	$\delta_{N\infty}$	V	δ_{v0}	$\delta_{v\infty}$
		[mm]	[kN]	[mm/kN]	[mm]	[mm]	[kN]	[mm]	[mm]
M8	12x80	80	0,17	0,80	0,14	0,27	0,3	0,9	1,35
M8 / M10/ IG-M6	16x85	85							
	16x130	130	0,14		0,11	0,23			
M12 / M16 / IG-M8 / IG-M10	20x85	85	0,17		0,14	0,27			
	20x130	130	0,14	0,11	0,23				

Injection System VMU plus for masonry

Performance - Clay hollow brick Brique creuse C40
Characteristic values of resistance, Displacements

Annex C35

Brick type: Clay hollow brick Blocchi Leggeri

Table C88: Description of the brick

Brick type	Clay hollow brick Blocchi Leggeri		
Bulk density ρ [kg/dm ³]	0,6		
Compressive strength $f_b \geq$ [N/mm ²]	4, 6, 8 or 12		
Code	EN 771-1		
Producer (country code)	e.g. Wienerberger (IT)		
Brick dimensions [mm]	250 x 120 x 250		
Drilling method	Rotary		

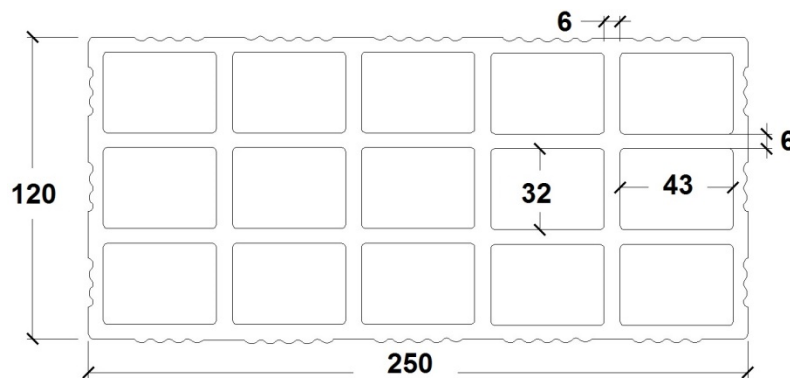
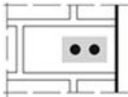
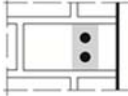

Table C89: Spacing and edge distances

Anchor size			All sizes
Edge distance	C_{cr}	[mm]	100 (120) ¹⁾
Minimum edge distance	C_{min}	[mm]	60
Spacing	$S_{cr,II}$	[mm]	250
	$S_{cr,\perp}$	[mm]	120
Minimum spacing	S_{min}	[mm]	100

¹⁾ Value in brackets for VM-SH 20x85; VM-SH 20x130 and VM-SH 20x200

Table C90: Group factor for anchor group in case of tension loading

Configuration		with c [mm] \geq	with s [mm] \geq			
II: anchors placed parallel to horizontal joint		60	100	$\alpha_{g,N,II}$	[-]	1,0
		C_{cr}	250			2,0
I: anchors placed perpendicular to horizontal joint		60	100	$\alpha_{g,N,\perp}$		2,0

Injection System VMU plus for masonry

Performance - Clay hollow brick Blocchi Leggeri
Description of the brick, Spacing and edge distances, Group factor

Annex C36

Brick type: Clay hollow brick Blocchi Leggeri

Table C91: Group factor for anchor group in case of shear loading parallel to free edge

Configuration		with c [mm] ≥	with s [mm] ≥			
II: anchors placed parallel to horizontal joint		60 ¹⁾	100 ¹⁾	$\alpha_{g,V,II}$	[-]	1,0
		c_{cr}	250			2,0
⊥: anchors placed perpendicular to horizontal joint		60 ¹⁾	100 ¹⁾	$\alpha_{g,V,\perp}$		1,6
		c_{cr}	250			2,0

¹⁾ Only valid for $V_{Rk,b}$ according to Table C93 and C94 values in brackets

Table C92: Group factor for anchor group in case of shear load perpendicular to free edge

Configuration		with c [mm] ≥	with s [mm] ≥			
II: anchors placed parallel to horizontal joint		60 ¹⁾	100 ¹⁾	$\alpha_{g,V,II}$	[-]	1,0
		c_{cr}	250			2,0
⊥: anchors placed perpendicular to horizontal joint		60 ¹⁾	100 ¹⁾	$\alpha_{g,V,\perp}$		1,6
		c_{cr}	250			2,0

¹⁾ Only valid for $V_{Rk,b}$ according to Table C93 and C94 values in brackets

Table C93: Characteristic values of resistance under tension and shear load

Anchor size	Sleeve	Effective Anchorage depth	Characteristic resistance			
			Use category			
			d/d w/d w/w			d/d w/d w/w
			40°C/24°C	80°C/50°C	120°C/72°C	All temperature ranges
		h_{ef}	$N_{Rk,b} = N_{Rk,p}^{1)}$			$V_{Rk,b}^{4)}$
		[mm]	[kN]			[kN]
Compressive strength $f_b \geq 4 \text{ N/mm}^2$						
M8	12x80	80	0,4	0,4	0,3	2,0 ²⁾ (0,9) ³⁾
M8 / M10 / IG-M6	16x85	85				
	16x130	130				
M12 / M16 / IG-M8 / IG-M10	20x85	85				
	20x130	130				
	20x200	200				

¹⁾ Values are valid for c_{cr} and c_{min}

²⁾ Calculation of $V_{Rk,c}$ see ETAG 029, Annex C, except for shear load parallel to free edge with $c \geq 125 \text{ mm}$: $V_{Rk,c,II} = V_{Rk,b}$

³⁾ Values in brackets $V_{Rk,c} = V_{Rk,b}$ for anchors with c_{min}

⁴⁾ The values are valid for steel 5.6 or higher. For steel 4.6 and 4.8 multiply $V_{Rk,b}$ by 0,8

Injection System VMU plus for masonry

Performance - Clay hollow brick Blocchi Leggeri
Group factor, Characteristic values of resistance

Annex C37

Brick type: Clay hollow brick Blocchi Leggeri

Table C94: Characteristic values of resistance under tension and shear load (continue)

Anchor size	Sleeve	Effective Anchorage depth	Characteristic resistance			
			Use category			
			d/d w/d w/w			d/d w/d w/w
			40°C/24°C	80°C/50°C	120°C/72°C	All temperature ranges
h _{ef}		N _{Rk,b} = N _{Rk,p} ¹⁾			V _{Rk,b} ⁴⁾	
[mm]		[kN]			[kN]	
Compressive strength $f_b \geq 6 \text{ N/mm}^2$						
M8	12x80	80	0,5	0,5	0,4	2,5 ²⁾ (1,2) ³⁾
M8 / M10/ IG-M6	16x85	85				
	16x130	130				
M12 / M16 / IG-M8 /	20x85	85				
	20x130	130				
	20x200	200				
Compressive strength $f_b \geq 8 \text{ N/mm}^2$						
M8	12x80	80	0,6	0,6	0,5	3,0 ²⁾ (1,2) ³⁾
M8 / M10/ IG-M6	16x85	85				
	16x130	130				
M12 / M16 / IG-M8 /	20x85	85				
	20x130	130				
	20x200	200				
Compressive strength $f_b \geq 12 \text{ N/mm}^2$						
M8	12x80	80	0,6	0,6	0,6	3,5 ²⁾ (1,5) ³⁾
M8 / M10/ IG-M6	16x85	85				
	16x130	130				
M12 / M16 / IG-M8 /	20x85	85				
	20x130	130				
	20x200	200				

1) Values are valid for C_{cr} and C_{min}

2) Calculation of V_{Rk,c} see ETAG 029, Annex C, except for shear load parallel to free edge with c ≥ 125 mm: V_{Rk,c,II} = V_{Rk,b}

3) Values in brackets V_{Rk,c} = V_{Rk,b} for anchors with C_{min}

4) The values are valid for steel 5.6 or higher. For steel 4.6 and 4.8 multiply V_{Rk,b} by 0,8

Table C95: Displacements

Anchor size	Sleeve	h _{ef}	N	δ _N / N	δ _{N0}	δ _{N∞}	V	δ _{v0}	δ _{v∞}
		[mm]	[kN]	[mm/kN]	[mm]	[mm]	[kN]	[mm]	[mm]
All sizes	All sizes	All sizes	0,17	1,20	0,21	0,41	0,9	1,20	1,80

Injection System VMU plus for masonry

Performance - Clay hollow brick Blocchi Leggeri
Characteristic values of resistance, Displacements

Annex C38

Brick type: Clay hollow brick Doppio Uni

Table C96: Description of the brick

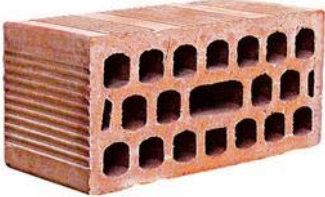
Brick type	Clay hollow brick Doppio Uni		
Bulk density ρ [kg/dm ³]		0,9	
Compressive strength $f_b \geq$ [N/mm ²]		10, 16, 20 or 28	
Code		EN 771-1	
Producer (country code)		e.g. Wienerberger (IT)	
Brick dimensions [mm]		250 x 120 x 120	
Drilling method		Rotary	

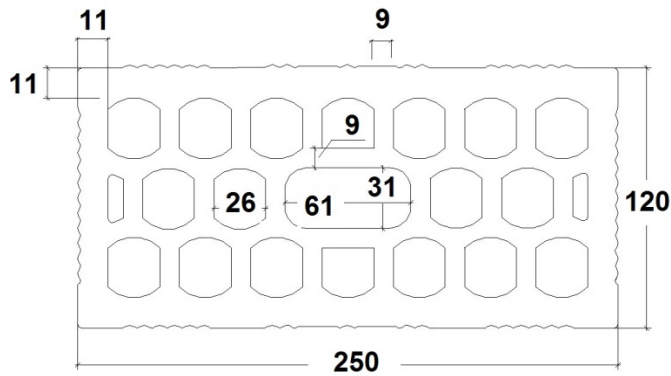
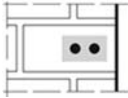
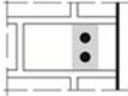

Table C97: Spacing and edge distances

Anchor size		All sizes	
Edge distance	C_{cr} [mm]	100 (120) ¹⁾	
Minimum edge distance	$C_{min}^{2)}$ [mm]	60	
Spacing	$S_{cr,II}$ [mm]	250	
	$S_{cr,\perp}$ [mm]	120	
Minimum spacing	$S_{min,II}$ [mm]	100	
	$S_{min,\perp}$ [mm]	120	

1) Value in brackets for VM-SH 20x85; VM-SH 20x130 and VM-SH 20x200
 2) For $V_{Rk,c}$: C_{min} according to ETAG 029, Annex C

Table C98: Group factor for anchor group in case of tension loading

Configuration		with c [mm] \geq	with s [mm] \geq			
II: anchors placed parallel to horizontal joint		60	100	$\alpha_{g,N,II}$	[-]	1,0
		C_{cr}	250			2,0
I: anchors placed perpendicular to horizontal joint		60	100	$\alpha_{g,N,\perp}$		2,0

Injection System VMU plus for masonry

Performance - Clay hollow brick Doppio Uni

Description of the brick, Spacing and edge distances, Group factor

Annex C39

Brick type: Clay hollow brick Doppio Uni

Table C99: Group factor for anchor group in case of shear loading parallel to free edge

Configuration		with c [mm] ≥	with s [mm] ≥			
: anchors placed parallel to horizontal joint		C_{cr}	250	$\alpha_{g,V, }$	[-]	2,0
⊥: anchors placed perpendicular to horizontal joint		C_{cr}	120	$\alpha_{g,V,\perp}$		2,0

Table C100: Group factor for anchor group in case of shear load perpendicular to free edge

Configuration		with c [mm] ≥	with s [mm] ≥			
: anchors placed parallel to horizontal joint		C_{cr}	250	$\alpha_{g,V, }$	[-]	2,0
⊥: anchors placed perpendicular to horizontal joint		C_{cr}	120	$\alpha_{g,V,\perp}$		2,0

Table C101: Characteristic values of resistance under tension and shear load

Anchor size	Sleeve	Effective Anchorage depth	Characteristic resistance			
			Use category			
			d/d w/d w/w			d/d w/d w/w
			40°C/24°C	80°C/50°C	120°C/72°C	All temperature ranges
		h_{ef}	$N_{Rk,b} = N_{Rk,p}^{1)}$			$V_{Rk,b}^{2)3)}$
		[mm]	[kN]			[kN]
Compressive strength $f_b \geq 10 \text{ N/mm}^2$						
M8	12x80	80	0,6	0,6	0,5	1,5
M8 / M10/ IG-M6	16x85	85				
	16x130	130				
M12 / M16 / IG-M8 / IG-M10	20x85	85				
	20x130	130				
	20x200	200				

1) Values are valid for C_{cr} and C_{min}

2) Calculation of $V_{Rk,c}$ see ETAG 029, Annex C

3) The values are valid for steel 5.6 or higher. For steel 4.6 and 4.8 multiply $V_{Rk,b}$ by 0,8

Injection System VMU plus for masonry

Performance - Clay hollow brick Doppio Uni
Group factor, Characteristic values of resistance

Annex C40

Brick type: Clay hollow brick Doppio Uni

Table C102: Characteristic values of resistance under tension and shear load (continue)

Anchor size	Sleeve	Effective Anchorage depth	Characteristic resistance			
			Use category			
			d/d w/d w/w			d/d w/d w/w
			40°C/24°C	80°C/50°C	120°C/72°C	All temperature ranges
h _{ef}		N _{Rk,b} = N _{Rk,p} ¹⁾			V _{Rk,b} ²⁾³⁾	
[mm]		[kN]			[kN]	
Compressive strength $f_b \geq 16 \text{ N/mm}^2$						
M8	12x80	80	0,75	0,75	0,6	2,0
M8 / M10/ IG-M6	16x85	85				
	16x130	130				
M12 / M16 / IG-M8 / IG-M10	20x85	85				
	20x130	130				
	20x200	200				
Compressive strength $f_b \geq 20 \text{ N/mm}^2$						
M8	12x80	80	0,9	0,9	0,75	2,0
M8 / M10/ IG-M6	16x85	85				
	16x130	130				
M12 / M16 / IG-M8 / IG-M10	20x85	85				
	20x130	130				
	20x200	200				
Compressive strength $f_b \geq 28 \text{ N/mm}^2$						
M8	12x80	80	1,2	1,2	0,9	2,5
M8 / M10/ IG-M6	16x85	85				
	16x130	130				
M12 / M16 / IG-M8 / IG-M10	20x85	85				
	20x130	130				
	20x200	200				

1) Values are valid for c_{cr} and c_{min}

2) Calculation of $V_{Rk,c}$ see ETAG 029, Annex C

3) The values are valid for steel 5.6 or higher. For steel 4.6 and 4.8 multiply $V_{Rk,b}$ by 0,8

Table C103: Displacements

Anchor size	Sleeve	h _{ef}	N	δ_N / N	δ_{N0}	$\delta_{N\infty}$	V	δ_{v0}	$\delta_{v\infty}$
		[mm]	[kN]	[mm/kN]	[mm]	[mm]	[kN]	[mm]	[mm]
All sizes	All sizes	All sizes	0,26	1,20	0,31	0,62	0,6	0,3	0,45

Injection System VMU plus for masonry

Performance - Clay hollow brick Doppio Uni
Characteristic values of resistance, Displacements

Annex C41

Brick type: Hollow lightweight concrete Bloc creux B40

Table C104: Description of the brick

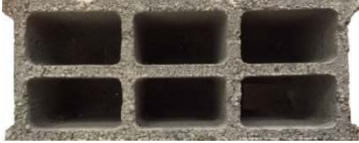
Brick type	Hollow Lightweight concrete Bloc creux B40		
Bulk density	ρ [kg/dm ³]	0,8	
Compressive strength	$f_b \geq$ [N/mm ²]	4	
Code	EN 771-3		
Producer (country code)	e.g. Sepa (FR)		
Brick dimensions	[mm]	494 x 200 x 190	
Drilling method	Rotary		

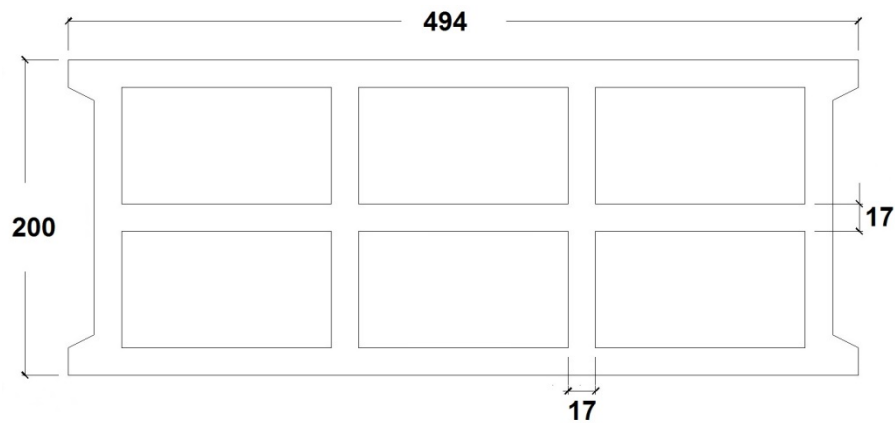

Table C105: Spacing and edge distances

Anchor size			All sizes
Edge distance	C_{cr}	[mm]	100 (120) ¹⁾
Minimum edge distance	$C_{min}^{2)}$	[mm]	100 (120) ¹⁾
Spacing	$S_{cr,II}$	[mm]	494
	$S_{cr,\perp}$	[mm]	190
Minimum spacing	S_{min}	[mm]	100

¹⁾ Value in brackets for VM-SH 20x85 and VM-SH 20x130

²⁾ For $V_{Rk,c}$: C_{min} according to ETAG 029, Annex C

Table C106: Group factor for anchor group in case of tension loading

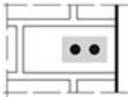
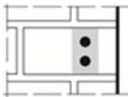
Configuration		with c [mm] \geq	with s [mm] \geq	$\alpha_{g,N,II}$	[-]	1,5
II: anchors placed parallel to horizontal joint		100	100			
		C_{cr}	494			
\perp : anchors placed perpendicular to horizontal joint		100	100	$\alpha_{g,N,\perp}$	2,0	
		C_{cr}	190			

Injection System VMU plus for masonry

Annex C42

Performance - Hollow Lightweight concrete Bloc creux B40

Description of the brick, Spacing and edge distances, Group factor

Brick type: Hollow lightweight concrete Bloc creux B40

Table C107: Group factor for anchor group in case of shear loading parallel to free edge

Configuration		with c [mm] ≥	with s [mm] ≥			
II: anchors placed parallel to horizontal joint		50	100	$\alpha_{g,V,II}$	[-]	1,1
		c_{cr}	494			2,0
⊥: anchors placed perpendicular to horizontal joint		100	100	$\alpha_{g,V,\perp}$	[-]	1,1
		c_{cr}	190			2,0

Table C108: Group factor for anchor group in case of shear load perpendicular to free edge

Configuration		with c [mm] ≥	with s [mm] ≥			
II: anchors placed parallel to horizontal joint		c_{cr}	494	$\alpha_{g,V,II}$	[-]	2,0
		c_{cr}	190			$\alpha_{g,V,\perp}$

Table C109: Characteristic values of resistance under tension and shear load

Anchor size	Sleeve	Effective anchorage depth	Characteristic resistance							
			Use category							
			d/d			w/d w/w			d/d w/d w/w	
			40°C/24°C	80°C/50°C	120°C/72°C	40°C/24°C	80°C/50°C	120°C/72°C	All temperature ranges	
		h_{ef}	$N_{Rk,b} = N_{Rk,p}^{1)}$			$N_{Rk,b} = N_{Rk,p}^{1)}$			$V_{Rk,b}^{2)3)}$	
		[mm]	[kN]							
Compressive strength $f_b \geq 4 \text{ N/mm}^2$										
M8	12x80	80	1,2	0,9	0,75	0,9	0,75	3,0		
M8 / M10/ IG-M6	16x85	85								0,9
	16x130	130								1,2
M12 / M16 / IG-M8 / IG-M10	20x85	85								1,2
	20x130	130	1,2							

1) Values are valid for c_{cr} and c_{min}

2) Calculation of $V_{Rk,c}$ see ETAG 029, Annex C, except for shear load parallel to free edge with $c \geq 250 \text{ mm}$: $V_{Rk,c,II} = V_{Rk,b}$

3) The values are valid for steel 5.6 or higher. For steel 4.6 and 4.8 multiply $V_{Rk,b}$ by 0,8

Table C110: Displacements

Anchor size	Sleeve	h_{ef}	N	δ_N / N	δ_{N0}	$\delta_{N\infty}$	V	δ_{V0}	$\delta_{V\infty}$
		[mm]	[kN]	[mm/kN]	[mm]	[mm]	[kN]	[mm]	[mm]
All sizes	All sizes	All sizes	0,34	0,90	0,31	0,62	0,86	0,9	1,35

Injection System VMU plus for masonry

Performance - Hollow lightweight concrete Bloc creux B40
Group factor, Characteristic values of resistance, Displacements

Annex C43

Brick type: Solid lightweight concrete - LAC

Table C111: Description of the brick

Brick type	Solid lightweight concrete LAC		
Bulk density	ρ [kg/dm ³]	0,6	
Compressive strength	$f_b \geq$ [N/mm ²]	2	
Code	EN 771-3		
Producer (country code)	e.g. Bisotherm (DE)		
Brick dimensions	[mm]	300 x 123 x 248	
Drilling method	Rotary		

Table C112: Spacing and edge distances

Anchor size			All sizes
Edge distance	c_{cr}	[mm]	$1,5 \cdot h_{ef}$
Minimum edge distance	c_{min}	[mm]	60
Spacing	s_{cr}	[mm]	$3 \cdot h_{ef}$
Minimum spacing	s_{min}	[mm]	120

Table C113: Group factor for anchor group in case of tension loading

Configuration		with c [mm] \geq	with s [mm] \geq	$\alpha_{g,N,II}$	[-]	
II: anchors placed parallel to horizontal joint		90	120			
		$1,5 \cdot h_{ef}$	$3 \cdot h_{ef}$	2,0		
⊥: anchors placed perpendicular to horizontal joint		124	120	$\alpha_{g,N,\perp}$		1,1
		$1,5 \cdot h_{ef}$	$3 \cdot h_{ef}$			2,0

Table C114: Group factor for anchor group in case of shear loading parallel to free edge

Configuration		with c [mm] \geq	with s [mm] \geq	$\alpha_{g,V,II}$	[-]	
II: anchors placed parallel to horizontal joint		60	120			
		90	120	2,0		
⊥: anchors placed perpendicular to horizontal joint		60	120	$\alpha_{g,V,\perp}$		0,6
		124	120			2,0

Table C115: Group factor for anchor group in case of shear load perpendicular to free edge

Configuration		with c [mm] \geq	with s [mm] \geq	$\alpha_{g,V,II}$	[-]	
II: anchors placed parallel to horizontal joint		60	120			
		90	120	2,0		
⊥: anchors placed perpendicular to horizontal joint		60	120	$\alpha_{g,V,\perp}$		0,6
		$1,5 \cdot h_{ef}$	120			1,0
		$1,5 \cdot h_{ef}$	$3 \cdot h_{ef}$			2,0

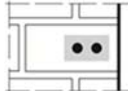
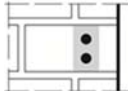
Injection System VMU plus for masonry

Annex C44

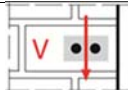
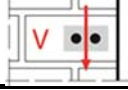
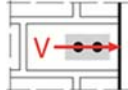
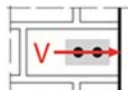
Performance - Solid lightweight concrete - LAC

Description of the brick, Spacing and edge distances, Group factor

Brick type: Solid lightweight concrete - LAC

Table C116: Characteristic values of resistance under tension and shear load

Anchor size	Sleeve	Effective anchorage depth	Characteristic resistance						
			Use category						
			d/d			w/d w/w			d/d w/d w/w
			40°C/24°C	80°C/50°C	120°C/72°C	40°C/24°C	80°C/50°C	120°C/72°C	All temperature ranges
			$N_{Rk,b} = N_{Rk,p}^{1)}$			$N_{Rk,b} = N_{Rk,p}^{1)}$			$V_{Rk,b}^{2)3)}$
		[mm]	[kN]						
Compressive strength $f_b \geq 2 \text{ N/mm}^2$									
M8	-	80	3,0	2,5	2,0	2,5	2,0	1,5	3,0
M8 / M10/ IG-M6	-	90	3,0	3,0	2,0	2,5	2,5	2,0	3,0
M10 / IG-M8	-	100	3,5	3,0	2,5	3,0	2,5	2,0	3,0
M16 / IG-M10	-	100	3,0	3,0	2,0	3,0	3,0	2,0	3,0
M8	12x80	80	2,5	2,5	2,0	2,5	2,0	1,5	3,0
M8 / M10/ IG-M6	16x85	85	3,0	2,5	2,0	3,0	2,5	2,0	3,0
	16x130	130	3,0	2,5	2,0	3,0	2,5	2,0	3,0
M12 / M16 / IG-M8 / IG-M10	20x85	85	2,5	2,5	2,0	2,5	2,5	2,0	3,0
	20x130	130							
	20x200	200							

- 1) Values are valid for c_{cr} , values in brackets are valid for single anchors with c_{min}
 2) For calculation of $V_{Rk,c}$ see ETAG029, Annex C
 3) The values are valid for steel 5.6 or higher. For steel 4.6 and 4.8 multiply $V_{Rk,b}$ by 0,8

Table C117: Displacements

Anchor size	Sleeve	h_{ef}	N	δ_N / N	δ_{N0}	$\delta_{N\infty}$	V	δ_{V0}	$\delta_{V\infty}$
		[mm]	[kN]	[mm/kN]	[mm]	[mm]	[kN]	[mm]	[mm]
M8	-	80	0,86	0,50	0,43	0,86	0,9	0,25	0,38
M8 / M10/ IG-M6	-	90							
M10 / IG-M8	-	100							
M16 / IG-M10	-	100							
M8	12x80	80	0,71	0,35	0,25	0,50	0,9	0,25	0,38
M8 / M10/ IG-M6	16x85	85							
	16x130	130							
M12 / M16 / IG-M8 / IG-M10	20x85	85							
	20x130	130							
	20x200	200							

Injection System VMU plus for masonry

Performance - Solid lightweight concrete - LAC
 Characteristic values of resistance, Displacements

Annex C45