

DECLARATION OF PERFORMANCE  
DoP No. MKT-621 - en

1. Unique identification code of the product-type: **MKT Injection System VMU plus**
2. Type, batch or serial number or any other element allowing identification of the construction product as required pursuant to Article 11(4):

**ETA-13/0909, Annex A2 and A3**  
**Batch number: see packaging of the product.**

3. Intended use or uses of the construction product, in accordance with the applicable harmonised technical specification, as foreseen by the manufacturer:

<b>generic type</b>	bonded anchor
<b>for use in</b>	masonry
<b>option</b>	b, c, d
<b>loading</b>	static or quasi-static
<b>material</b>	<p><u>hot-dip galvanized steel:</u> dry internal conditions only covered sizes: VMU-A, V-A: M8, M10, M12, M16 VMU-IG: M6, M8, M10</p> <p><u>zinc-plated steel:</u> dry internal conditions only covered sizes: VMU-A, V-A: M8, M10, M12, M16 VMU-IG: M6, M8, M10</p> <p><u>stainless steel (marking A4):</u> internal and external use without particular aggressive conditions covered sizes: VMU-A, V-A: M8, M10, M12, M16 VMU-IG: M6, M8, M10</p> <p><u>high corrosion resistant steel (marking HCR):</u> internal and external use with particular aggressive conditions covered sizes: VMU-A, V-A: M8, M10, M12, M16 VMU-IG: M6, M8, M10</p>
<b>temperature range</b> (if applicable)	<p>T<sub>a</sub>: -40 °C to +40 °C T<sub>b</sub>: -40 °C to +80 °C T<sub>c</sub>: -40 °C to +120 °C</p>

4. Name, registered trade name or registered trade mark and contact address of the manufacturer as required pursuant to Article 11(5):

**MKT Metall-Kunststoff-Technik GmbH & Co. KG**  
**Auf dem Immel 2**  
**D - 67685 Weilerbach**

5. Where applicable, name and contact address of the authorised representative whose mandate covers the tasks specified in Article 12(2): --
6. System or systems of assessment and verification of constancy of performance of the construction product as set out in Annex V: **System 1**
7. In case of the declaration of performance concerning a construction product covered by a harmonised standard: --

8. In case of the declaration of performance concerning a construction product for which a European Technical Assessment has been issued:

**Deutsches Institut für Bautechnik, Berlin**

issued

**ETA-13/0909**

on the basis of

**ETAG 029**

The notified body 1343-CPR performed under system 1:

- (i) determination of the product type on the basis of type testing (including sampling), type calculation, tabulated values or descriptive documentation of the product;
- (ii) initial inspection of the manufacturing plant and of factory production control;
- (iii) continuous surveillance, assessment and evaluation of factory production control.

and issued: certificate of conformity 1343-CPR-M 550-14/08.14

9. Declared performance:

Essential Characteristics	Design Method	Performance	Harmonized Technical Specification
characteristic values for resistance in masonry	ETAG 029, Annex C	ETA-13/0909, Annex C	ETAG 029
minimum spacing and minimum edge distance	ETAG 029, Annex C	ETA-13/0909, Annex C	
displacement for serviceability limit state	ETAG 029, Annex C	ETA-13/0909, Annex C	

Where pursuant to Article 37 or 38 in the Specific Technical Documentation has been used, the requirements with which the product complies: --

10. The performance of the product identified in points 1 and 2 is in conformity with the declared performance in point 9.

This declaration of performance is issued under the sole responsibility of the manufacturer identified in point 4.

Signed for and on behalf of the manufacturer by:

*Stefan Weustenhagen*  
**Stefan Weustenhagen**  
 (General Manager)  
**Weilerbach, 08.12.2016**

i.V. *Detlef Bigalke*  
**Dipl.-Ing. Detlef Bigalke**  
 (Head of product development)



**Table C1:  $\beta$  - factor for job-site testing under tension loading**

Brick-No. and abbreviation	Installation & Use category	$\beta$ -Factor					
		T <sub>a</sub> : 40°C / 24°C		T <sub>b</sub> : 80°C / 50°C		T <sub>c</sub> : 120°C / 72°C	
		d/d	w/d w/w	d/d	w/d w/w	d/d	w/d w/w
1 AAC6	All sizes	0,95	0,86	0,81	0,73	0,81	0,73
2 KS-NF	d <sub>0</sub> ≤ 14 mm	0,93	0,80	0,87	0,74	0,65	0,56
	d <sub>0</sub> ≥ 16 mm	0,93	0,93	0,87	0,87	0,65	0,65
3 KSL-3DF	d <sub>0</sub> ≤ 12 mm	0,93	0,80	0,87	0,74	0,65	0,56
	d <sub>0</sub> ≥ 16 mm	0,93	0,93	0,87	0,87	0,65	0,65
4 KSL-12DF	d <sub>0</sub> ≤ 12 mm	0,93	0,80	0,87	0,74	0,65	0,56
	d <sub>0</sub> ≥ 16 mm	0,93	0,93	0,87	0,87	0,65	0,65
5 MZ-DF	all sizes	0,86	0,86	0,86	0,86	0,73	0,73
6 Hiz-16DF							
7 Porotherm Homebric							
8 BGV-Thermo							
9 Calibric R+							
10 Urbanbric							
11 Brique creuse C40							
12 Blocchi Leggeri							
13 Doppio Uni							
14 Bloc creux B40	d <sub>0</sub> ≤ 12 mm	0,93	0,80	0,87	0,74	0,65	0,56
	d <sub>0</sub> ≥ 16 mm	0,93	0,93	0,87	0,87	0,65	0,65
15 Solid lightweight concrete	d <sub>0</sub> ≤ 12 mm	0,93	0,80	0,87	0,74	0,65	0,56
	d <sub>0</sub> ≥ 16 mm	0,93	0,93	0,87	0,87	0,65	0,65

**Injection System VMU plus for masonry**

**Performances**

$\beta$  - factors for job site testing under tension load

**Annex C1**

**Table C2: Characteristic steel resistance under tension and shear load**

Anchor type Anchor size			VMU-IG			VMU-A, V-A			
			M6	M8	M10	M8	M10	M12	M16
<b>Characteristic tension resistance</b>									
Steel, property class 4.6	$N_{Rk,s}$	[kN]	-	-	-	15	23	34	63
	$\gamma_{Ms}$	[-]	-			2,0			
Steel, property class 4.8	$N_{Rk,s}$	[kN]	-	-	-	15	23	34	63
	$\gamma_{Ms}$	[-]	-			1,5			
Steel, property class 5.6	$N_{Rk,s}$	[kN]	10	18	29	18	29	42	79
	$\gamma_{Ms}$	[-]	2,0			2,0			
Steel, property class 5.8	$N_{Rk,s}$	[kN]	10	17	29	18	29	42	79
	$\gamma_{Ms}$	[-]	1,5			1,5			
Steel, property class 8.8	$N_{Rk,s}$	[kN]	16	27	46	29	46	67	126
	$\gamma_{Ms}$	[-]	1,5			1,5			
Stainless steel A4 / HCR, property class 70	$N_{Rk,s}$	[kN]	14	26	41	26	41	59	110
	$\gamma_{Ms}$	[-]	1,87			1,87			
Stainless steel A4 / HCR, property class 80	$N_{Rk,s}$	[kN]	16	29	46	29	46	67	126
	$\gamma_{Ms}$	[-]	1,6			1,6			
<b>Characteristic shear resistance</b>									
Steel, property class 4.6	$V_{Rk,s}$	[kN]	-	-	-	7	12	17	31
	$\gamma_{Ms}$	[-]	-			1,67			
Steel, property class 4.8	$V_{Rk,s}$	[kN]	-	-	-	7	12	17	31
	$\gamma_{Ms}$	[-]	-			1,25			
Steel, property class 5.6	$V_{Rk,s}$	[kN]	5	9	15	9	15	21	39
	$\gamma_{Ms}$	[-]	1,67			1,67			
Steel, property class 5.8	$V_{Rk,s}$	[kN]	5	9	15	9	15	21	39
	$\gamma_{Ms}$	[-]	1,25			1,25			
Steel, property class 8.8	$V_{Rk,s}$	[kN]	8	14	23	15	23	34	63
	$\gamma_{Ms}$	[-]	1,25			1,25			
Stainless steel A4 / HCR, property class 70	$V_{Rk,s}$	[kN]	7	13	20	13	20	30	55
	$\gamma_{Ms}$	[-]	1,56			1,56			
Stainless steel A4 / HCR, property class 80	$V_{Rk,s}$	[kN]	8	15	23	15	23	34	63
	$\gamma_{Ms}$	[-]	1,33			1,33			
<b>Characteristic bending moment</b>									
Steel, property class 4.6	$M_{Rk,s}$	[Nm]	-	-	-	15	30	52	133
	$\gamma_{Ms}$	[-]	-			1,67			
Steel, property class 4.8	$M_{Rk,s}$	[Nm]	-	-	-	15	30	52	133
	$\gamma_{Ms}$	[-]	-			1,25			
Steel, property class 5.6	$M_{Rk,s}$	[Nm]	8	19	37	19	37	66	167
	$\gamma_{Ms}$	[-]	1,67			1,67			
Steel, property class 5.8	$M_{Rk,s}$	[Nm]	8	19	37	19	37	66	167
	$\gamma_{Ms}$	[-]	1,25			1,25			
Steel, property class 8.8	$M_{Rk,s}$	[Nm]	12	30	60	30	60	105	266
	$\gamma_{Ms}$	[-]	1,25			1,25			
Stainless steel A4 / HCR, property class 70	$M_{Rk,s}$	[Nm]	11	26	52	26	52	92	233
	$\gamma_{Ms}$	[-]	1,56			1,56			
Stainless steel A4 / HCR, property class 80	$M_{Rk,s}$	[Nm]	12	30	60	30	60	105	266
	$\gamma_{Ms}$	[-]	1,33			1,33			

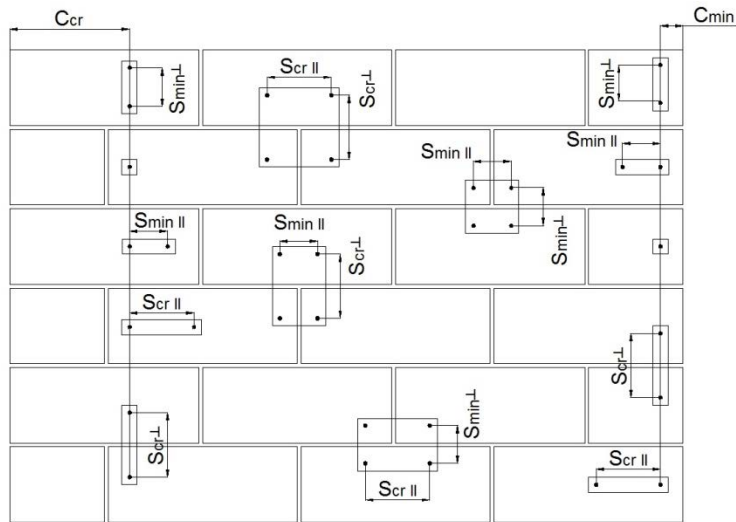
**Injection System VMU plus for masonry**

**Performances**

Characteristic steel resistance under tension and shear load

**Annex C2**

## Spacing and edge distance



$C_{cr}$  = Characteristic edge distance  
 $C_{min}$  = Minimum edge distance  
 $S_{cr}$  = Characteristic spacing  
 $S_{min}$  = Minimum spacing

$S_{cr,II}; (S_{min,II})$  = Characteristic (minimum) spacing for anchors placed parallel to bed joint  
 $S_{cr,\perp}; (S_{min,\perp})$  = Characteristic (minimum) spacing for anchors placed perpendicular to bed joint

Load direction \ Anchor position	Tension load	Shear load parallel to free edge	Shear load perpendicular to free edge
Anchors places parallel to bed joint $S_{cr,II}; (S_{min,II})$			
Anchors places perpendicular to bed joint $S_{cr,\perp}; (S_{min,\perp})$			

$\alpha_{g,N,II}$  = Group factor in case of tension load for anchors placed parallel to the bed joint  
 $\alpha_{g,V,II}$  = Group factor in case of shear load for anchors placed parallel to the bed joint  
 $\alpha_{g,N,\perp}$  = Group factor in case of tension load for anchors placed perpendicular to the bed joint  
 $\alpha_{g,V,\perp}$  = Group factor in case of shear load for anchors placed perpendicular to the bed joint

Group of 2 anchors:  $N_{RK}^g = \alpha_{g,N} * N_{RK}$  and  $V_{RK}^g = \alpha_{g,V} * V_{RK}$

Group of 4 anchors:  $N_{RK}^g = \alpha_{g,N,II} * \alpha_{g,N,\perp} * N_{RK}$  and  $V_{RK}^g = \alpha_{g,V,II} * \alpha_{g,V,\perp} * V_{RK}$

$(N_{RK}: N_{RK,b}$  or  $N_{RK,b,j}$  for  $C_{cr}$ )  
 $(V_{RK}: V_{RK,c}; V_{RK,c,j}; V_{RK,b}$  or  $V_{RK,b,j}$  for  $C_{cr}$ )  
 (with the relevant  $\alpha_g$ )


### Injection System VMU plus for masonry

**Performances**  
 Edge distance and Spacing

**Annex C3**

**Brick type: Autoclaved Aerated Concrete – AAC6**

**Table C3: Description of the brick**

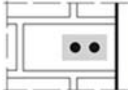
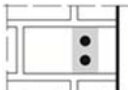
Brick type	Autoclaved Aerated Concrete AAC6		
Bulk density	$\rho$ [kg/dm <sup>3</sup> ]	0,6	
Compressive strength	$f_b \geq$ [N/mm <sup>2</sup> ]	6	
Code	EN 771-4		
Producer (country code)	e.g. Porit (DE)		
Brick dimensions	[mm]	499 x 240 x 249	
Drilling method	Rotary		

**Table C4: Spacing and edge distance**

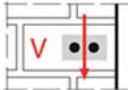
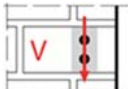
Anchor size			All sizes
Edge distance	$C_{cr}$	[mm]	$1,5 \cdot h_{ef}$
Minimum edge distance	$C_{min,N}$	[mm]	75
	$C_{min,V,II}$ ( $C_{min,v,\perp}$ ) <sup>1)</sup>	[mm]	$75 (1,5 \cdot h_{ef})$
Spacing	$S_{cr}$	[mm]	$3 \cdot h_{ef}$
Minimum spacing	$S_{min}$	[mm]	100

<sup>1)</sup>  $C_{min,v,II}$  for shear loading parallel to the free edge;  $C_{min,v,\perp}$  for shear loading perpendicular free edge

**Table C5: Group factor for anchor group in case of tension loading**

Configuration		with $c$ [mm] $\geq$	with $s$ [mm] $\geq$			
II: anchors placed parallel to horizontal joint		125 (120 for M8)	100	$\alpha_{g,N,II}$	[-]	1,8
		$1,5 \cdot h_{ef}$	$3 \cdot h_{ef}$			2,0
⊥: anchors placed perpendicular to horizontal joint		75	100	$\alpha_{g,N,\perp}$	[-]	1,4
		$1,5 \cdot h_{ef}$	$3 \cdot h_{ef}$			2,0

**Table C6: Group factor for anchor group in case of shear loading parallel to free edge**

Configuration		with $c$ [mm] $\geq$	with $s$ [mm] $\geq$			
II: anchors placed parallel to horizontal joint		75	100	$\alpha_{g,V,II}$	[-]	1,2
		$1,5 \cdot h_{ef}$	$3 \cdot h_{ef}$			2,0
⊥: anchors placed perpendicular to horizontal joint		$1,5 \cdot h_{ef}$	$3 \cdot h_{ef}$	$\alpha_{g,V,\perp}$		2,0

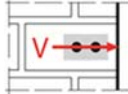
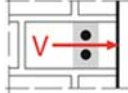
**Injection System VMU plus for masonry**

**Performances - Autoclaved Aerated Concrete - AAC6**  
Description of the brick, Spacing and edge distance, Group factors

**Annex C4**

**Brick type: Autoclaved Aerated Concrete – AAC6**

**Table C7: Group factor for anchor group in case of shear loading perpendicular to free edge**

Configuration		with c [mm] ≥	with s [mm] ≥			
II: anchors placed parallel to horizontal joint		1,5*hef	3,0*hef	$\alpha_{g,V,II}$	[-]	2,0
I: anchors placed perpendicular to horizontal joint		1,5*hef	3,0*hef	$\alpha_{g,V,I}$		2,0

**Table C8: Characteristic values of resistance under tension and shear loads**

Anchor size	Effective anchorage depth	Characteristic resistance						
		Use category						
		d/d			w/w			d/d
		40°C/24°C	80°C/50°C	120°C/72°C	40°C/24°C	80°C/50°C	120°C/72°C	w/d
								All temperature ranges
	hef	$N_{Rk,b} = N_{Rk,p}^{1)}$			$N_{Rk,b} = N_{Rk,p}^{1)}$			$V_{Rk,b}^{2)3)}$
	[mm]	[kN]						
Compressive strength $f_b \geq 6 \text{ N/mm}^2$								
M8	80	2,5 (2,0)	2,5 (1,5)	2,0 (1,2)	2,5 (1,5)	2,0 (1,5)	1,5 (1,2)	6,0
M10/IG-M6	90	4,0 (2,5)	3,0 (2,0)	2,5 (1,5)	3,5 (2,5)	3,0 (2,0)	2,5 (1,5)	10,0
M12/IG-M8	100	5,0 (3,5)	4,0 (3,0)	3,0 (2,5)	4,5 (3,0)	3,5 (2,5)	3,0 (2,5)	10,0
M16/IG-M10	100	6,5 (4,5)	5,5 (3,5)	4,0 (3,0)	5,5 (4,0)	5,0 (3,5)	4,0 (3,0)	10,0

1) Values are valid for  $c_{cr}$ , values in brackets are valid for single anchors with  $c_{min}$

2) For calculation of  $V_{Rk,c}$  see ETAG029, Annex C;

3) The values are valid for steel 5.6 or higher. For steel 4.6 and 4.8 multiply  $V_{Rk,b}$  by 0,8

**Table C9: Displacements**

Anchor size	hef	N	$\delta N / N$	$\delta N_0$	$\delta N_\infty$	V	$\delta V_0$	$\delta V_\infty$
	[mm]	[kN]	[mm/kN]	[mm]	[mm]	[kN]	[mm]	[mm]
M8	80	0,9	0,18	0,16	0,32	1,3	0,8	1,20
M10/IG-M6	90	1,4		0,26	0,51	1,8	1,2	1,80
M12/IG-M8	100	1,8	0,08	0,14	0,29	2,1	1,4	2,10
M16/IG-M10	100	2,3		0,19	0,37	2,3	1,5	2,25

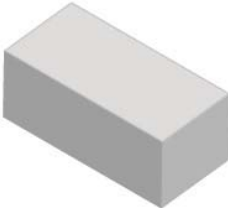
**Injection System VMU plus for masonry**

Performances - Autoclaved Aerated Concrete – AAC6  
Group factor, Characteristic values of resistance, Displacements

**Annex C5**

**Brick type: Calcium silicate solid brick KS-NF**

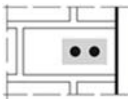
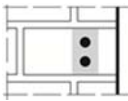
**Table C10: Description of the brick**

Brick type	Calcium silicate solid brick KS-NF		
Bulk density $\rho$ [kg/dm <sup>3</sup> ]		2,0	
Compressive strength $f_b \geq$ [N/mm <sup>2</sup> ]		10, 20 or 27	
Code		EN 771-2	
Producer (country code)		e.g. Wemding (DE)	
Brick dimensions [mm]		240 x 115 x 71	
Drilling method		Hammer	

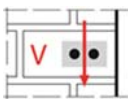
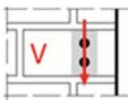
**Table C11: Spacing and edge distance**

Anchor size			All sizes
Edge distance	$c_{cr}$	[mm]	$1,5 \cdot h_{ef}$
Minimum edge distance	$c_{min}$	[mm]	60
Spacing	$s_{cr}$	[mm]	$3 \cdot h_{ef}$
Minimum spacing	$s_{min}$	[mm]	120

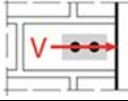
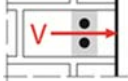
**Table C12: Group factor for anchor group in case of tension loading**

Configuration		with $c$ [mm] $\geq$	with $s$ [mm] $\geq$			
II: anchors placed parallel to horizontal joint 		60	120	$\alpha_{g,N,II}$	[-]	1,0
		140	120			1,5
		$1,5 \cdot h_{ef}$	$3 \cdot h_{ef}$			2,0
⊥: anchors placed perpendicular to horizontal joint 		60	120	$\alpha_{g,N,\perp}$	[-]	0,5
		$1,5 \cdot h_{ef}$	120			1,0
		$1,5 \cdot h_{ef}$	$3 \cdot h_{ef}$			2,0

**Table C13: Group factor for anchor group in case of shear loading parallel to free edge**

Configuration		with $c$ [mm] $\geq$	with $s$ [mm] $\geq$			
II: anchors placed parallel to horizontal joint 		60	120	$\alpha_{g,V,II}$	[-]	1,0
		115	120			1,7
		$1,5 \cdot h_{ef}$	$3 \cdot h_{ef}$			2,0
⊥: anchors placed perpendicular to horizontal joint 		60	120	$\alpha_{g,V,\perp}$	[-]	1,0
		$1,5 \cdot h_{ef}$	120			1,0
		$1,5 \cdot h_{ef}$	$3 \cdot h_{ef}$			2,0

**Table C14: Group factor for anchor group in case of shear loading perpendicular to free edge**

Configuration		with $c$ [mm] $\geq$	with $s$ [mm] $\geq$			
II: anchors placed parallel to horizontal joint 		60	120	$\alpha_{g,V,II}$	[-]	1,0
		$1,5 \cdot h_{ef}$	$3 \cdot h_{ef}$			2,0
⊥: anchors placed perpendicular to horizontal joint 		60	120	$\alpha_{g,V,\perp}$	[-]	1,0
		$1,5 \cdot h_{ef}$	$3 \cdot h_{ef}$			2,0

**Injection System VMU plus for masonry**

**Performances - Calcium solid brick KS-NF**  
Description, Spacing and edge distance, Group factor

**Annex C6**



Brick type: Calcium silicate solid brick KS-NF

Table C15: Characteristic values of resistance under tension and shear loads

Anchor size	Sleeve	Effective anchorage depth	Characteristic resistance							All temperature ranges
			Use category							
			d/d			w/d			d/d	
			40°C/24°C	80°C/50°C	120°C/72°C	40°C/24°C	80°C/50°C	120°C/72°C	w/d	
h <sub>ef</sub>	N <sub>Rk,b</sub> = N <sub>Rk,p</sub> <sup>1)</sup>			N <sub>Rk,b</sub> = N <sub>Rk,p</sub> <sup>1)</sup>			V <sub>Rk,b</sub> <sup>2)3)</sup>			
[mm]	[kN]									
<b>Compressive strength f<sub>b</sub> ≥ 10 N/mm<sup>2</sup></b>										
M8	-	80							2,5 (1,5)	
M10 / IG-M6	-	90	4,5 (2,0)	4,5 (2,0)	3,0 (1,5)	3,5 (1,5)	3,5 (1,5)	2,5 (1,2)	3,0 (2,0)	
M12 / IG-M8	-	100							2,5 (1,5)	
M16 / IG-M10	-	100	3,5 (1,5)	3,5 (1,5)	2,5 (1,2)	3,0 (1,5)	3,5 (1,5)	2,0 (0,9)	2,5 (1,5)	
M8	12x80	80	3,5 (1,5)	3,5 (1,5)	2,5 (1,2)	3,5 (1,5)	3,0 (1,5)	2,5 (1,2)	2,5 (1,5)	
M8 / M10 / IG-M6	16x85	85	3,5 (1,5)	3,0 (1,5)	2,0 (0,9)	3,5 (1,5)	3,0 (1,5)	2,5 (1,2)	2,5 (1,5)	
	16x130	130	3,5 (1,5)	3,0 (1,5)	2,0 (0,9)	3,5 (1,5)	3,0 (1,5)	2,5 (1,2)	2,5 (1,5)	
M12 / M16 / IG-M8 / IG-M10	20x85	85								
	20x130	130	3,0 (1,5)	2,5 (1,2)	2,0 (0,9)	3,0 (1,5)	2,5 (1,2)	2,0 (0,9)	2,5 (1,5)	
	20x200	200								
<b>Compressive strength f<sub>b</sub> ≥ 20 N/mm<sup>2</sup></b>										
M8	-	80							4,0 (2,5)	
M10 / IG-M6	-	90	6,0 (3,0)	5,5 (2,5)	4,0 (2,0)	5,0 (2,5)	5,0 (2,5)	3,5 (1,5)	4,5 (2,5)	
M12 / IG-M8	-	100							4,0 (2,5)	
M16 / IG-M10	-	100	5,0 (2,5)	5,0 (2,5)	3,5 (1,5)	5,0 (2,5)	5,0 (2,5)	3,5 (1,5)	4,0 (2,5)	
M8	12x80	80	5,5 (2,5)	5,0 (2,5)	3,5 (1,5)	4,5 (2,0)	4,5 (2,0)	3,0 (1,5)	4,0 (2,5)	
M8 / M10 / IG-M6	16x85	85	5,0 (2,5)	4,5 (2,0)	3,5 (1,5)	5,0 (2,5)	4,5 (2,0)	3,5 (1,5)	4,0 (2,5)	
	16x130	130	5,0 (2,5)	4,5 (2,0)	3,5 (1,5)	5,0 (2,5)	4,5 (2,0)	3,5 (1,5)	4,0 (2,5)	
M12 / M16 / IG-M8 / IG-M10	20x85	85								
	20x130	130	4,0 (2,0)	4,0 (2,0)	3,0 (1,5)	4,0 (2,0)	4,0 (2,0)	3,0 (1,5)	4,0 (2,5)	
	20x200	200								

- 1) Values are valid for c<sub>cr</sub>, values in brackets are valid for single anchors with c<sub>min</sub>  
 2) For c<sub>cr</sub> calculation of V<sub>Rk,c</sub> see ETAG 029, Annex C; values in brackets V<sub>Rk,c</sub> = V<sub>Rk,b</sub> for single anchors with c<sub>min</sub>  
 3) The values are valid for steel 5.6 or higher. For steel 4.6 and 4.8 multiply V<sub>Rk,b</sub> by 0,8.

Injection System VMU plus for masonry

Performances - Calcium solid brick KS-NF  
 Characteristic values of resistance

Annex C7

Brick type: Calcium silicate solid brick KS-NF

**Table C16: Characteristic values of resistance under tension and shear loads (continue)**

Anchor size	Sleeve	Effective anchorage depth	Characteristic resistance						
			Use category						
			d/d			w/d			d/d
			40°C/24°C	80°C/50°C	120°C/72°C	40°C/24°C	80°C/50°C	120°C/72°C	All temperature ranges
$h_{ef}$	$N_{Rk,b} = N_{Rk,p}^{1)}$			$N_{Rk,b} = N_{Rk,p}^{1)}$			$V_{Rk,b}^{2)3)}$		
[mm]	[kN]								
<b>Compressive strength <math>f_b \geq 27 \text{ N/mm}^2</math></b>									
M8	-	80							4,5 (2,5)
M10 / IG-M6	-	90	7,0 (3,5)	6,5 (3,0)	5,0 (2,5)	6,0 (3,0)	5,5 (2,5)	4,0 (2,0)	5,5 (3,0)
M12 / IG-M8	-	100							4,5 (2,5)
M16 / IG-M10	-	100	6,0 (3,0)	5,5 (2,5)	4,5 (2,0)	6,0 (3,0)	5,5 (2,5)	4,0 (2,0)	4,5 (2,5)
M8	12x80	80	6,5 (3,0)	6,0 (3,0)	4,5 (2,0)	5,5 (2,5)	5,0 (2,5)	3,5 (1,5)	4,5 (2,5)
M8 / M10 / IG-M6	16x85	85	5,5 (2,5)	5,0 (2,5)	4,0 (2,0)	5,5 (2,5)	5,0 (2,5)	4,0 (2,0)	4,5 (2,5)
	16x130	130	5,5 (2,5)	5,0 (2,5)	4,0 (2,0)	5,5 (2,5)	5,0 (2,5)	4,0 (2,0)	4,5 (2,5)
M12 / M16 / IG-M8 / IG-M10	20x85	85							
	20x130	130	5,0 (2,5)	4,5 (2,0)	3,5 (1,5)	5,0 (2,5)	4,5 (2,0)	3,5 (1,5)	4,5 (2,5)
	20x200	200							

- 1) Values are valid for  $c_{gr}$ , values in brackets are valid for single anchors with  $c_{min}$   
 2) For  $c_{gr}$  calculation of  $V_{Rk,c}$  see ETAG 029, Annex C; values in brackets  $V_{Rk,c} = V_{Rk,b}$  for single anchors with  $c_{min}$   
 3) The values are valid for steel 5.6 or higher. For steel 4.6 and 4.8 multiply  $V_{Rk,b}$  by 0,8

**Table C17: Displacements**

Anchor size	Sleeve	$h_{ef}$	N	$\delta_N / N$	$\delta_{N0}$	$\delta_{N\infty}$	V	$\delta_{V0}$	$\delta_{V\infty}$
		[mm]	[kN]	[mm/kN]	[mm]	[mm]	[kN]	[mm]	[mm]
M8	-	80	2,0	0,15	0,30	0,60	1,7	0,90	1,35
M10 / IG-M6	-	90							
M12 / IG-M8	-	100							
M16 / IG-M10	-	100	1,7		0,26	0,51			
M8 / M10 / IG-M6	12x80	80	1,4		0,21	0,43			
	16x130	130							
M12 / M16 / IG-M8 / IG-M10	20x85	85	1,3	0,19	0,39				
	20x130	130							
	20x200	200							

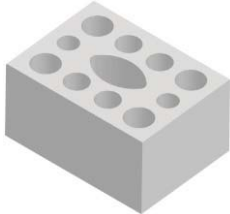
Injection System VMU plus for masonry

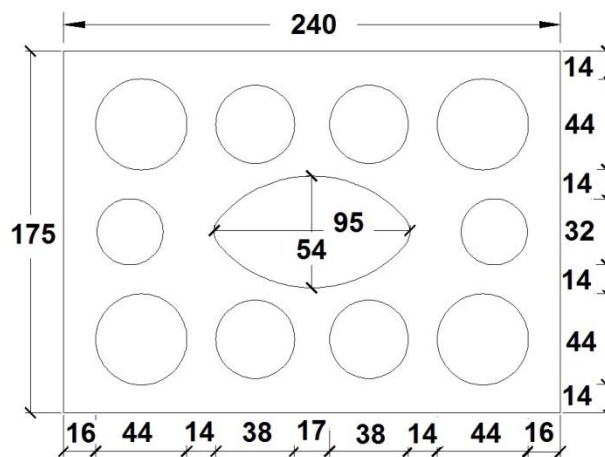
Performances - Calcium solid brick KS-NF  
 Characteristic values of resistance (continue), Displacements

**Annex C8**

**Brick type: Calcium silicate hollow brick KSL-3DF**

**Table C18: Description of the brick**

Brick type	Calcium silicate hollow brick KSL-3DF		
Bulk density	$\rho$ [kg/dm <sup>3</sup> ]	1,4	
Compressive strength	$f_b \geq$ [N/mm <sup>2</sup> ]	8, 12 or 14	
Code	EN 771-2		
Producer (country code)	e.g. Wemding (DE)		
Brick dimensions	[mm]	240 x 175 x 113	
Drilling method	Rotary		

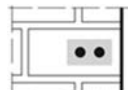
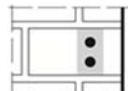


**Table C19: Spacing and edge distance**

Anchor size			All sizes
Edge distance	$C_{cr}$	[mm]	100 (120) <sup>1)</sup>
Minimum edge distance	$C_{min}$	[mm]	60
Spacing	$S_{cr,  }$	[mm]	240
	$S_{cr,\perp}$	[mm]	120
Minimum spacing	$S_{min}$	[mm]	120

<sup>1)</sup> Value in brackets for VM-SH 20x85; VM-SH 20x130 and VM-SH 20x200

**Table C20: Group factor for anchor group in case of tension loading**

Configuration		with $c$ [mm] $\geq$	with $s$ [mm] $\geq$			
: anchors placed parallel to horizontal joint		60	120	$\alpha_{g,N,  }$	[-]	1,5
		$C_{cr}$	240			2,0
		160	120			2,0
⊥: anchors placed perpendicular to horizontal joint		60	120	$\alpha_{g,N,\perp}$	[-]	1,0
		$C_{cr}$	120			2,0

**Injection System VMU plus for masonry**

**Performances - Calcium silicate hollow brick KSL-3DF**  
Description of the brick, Spacing and edge distance, Group factor

**Annex C9**

Brick type: Calcium silicate hollow brick KSL-3DF

**Table C21: Group factor for anchor group in case of shear loading parallel to free edge**

Configuration		with c [mm] ≥	with s [mm] ≥			
II: anchors placed parallel to horizontal joint		60	120	$\alpha_{g,V,II}$	[-]	1,0
		160	120			1,6
		$C_{cr}$	240			2,0
⊥: anchors placed perpendicular to horizontal joint		60	120	$\alpha_{g,V,\perp}$	[-]	1,0
		$C_{cr}$	120			2,0

**Table C22: Group factor for anchor group in case of shear loading perpendicular to free edge**

Configuration		with c [mm] ≥	with s [mm] ≥			
II: anchors placed parallel to horizontal joint		60	120	$\alpha_{g,V,II}$	[-]	1,0
		$C_{cr}$	240			2,0
⊥: anchors placed perpendicular to horizontal joint		60	120	$\alpha_{g,V,\perp}$	[-]	1,0
		$C_{cr}$	120			2,0

**Table C23: Characteristic values of resistance under tension and shear loads**

Anchor size	Sleeve	Effective anchorage depth	Characteristic resistance						
			Use category						
			d/d			w/d; w/w			d/d; w/d; w/w
			40°C/24°C	80°C/50°C	120°C/72°C	40°C/24°C	80°C/50°C	120°C/72°C	All temperature ranges
		$h_{ef}$	$N_{Rk,b} = N_{Rk,p}^{1)}$			$N_{Rk,b} = N_{Rk,p}^{1)}$			$V_{Rk,b}^{4)}$
		[mm]	[kN]						
<b>Compressive strength <math>f_b \geq 8 \text{ N/mm}^2</math></b>									
M8	12x80	80					1,2	0,9	$2,5^{2)}$ (0,9) <sup>3)</sup>
M8 / M10 / IG-M6	16x85	85	1,5	1,5	1,2	1,5	1,5	1,2	$4,0^{2)}$ (1,5) <sup>3)</sup>
	16x130	130					1,5	1,2	$4,0^{2)}$ (1,5) <sup>3)</sup>
M12 / M16 / IG-M8 / IG-M10	20x85	85							
	20x130	130	4,5	4,0	3,0	4,5	4,0	3,0	$4,0^{2)}$ (1,5) <sup>3)</sup>
	20x200	200							
<b>Compressive strength <math>f_b \geq 12 \text{ N/mm}^2</math></b>									
M8	12x80	80	2,0	2,0	1,5	2,0	1,5	1,2	$3,0^{2)}$ (1,2) <sup>3)</sup>
M8 / M10 / IG-M6	16x85	85	2,0	2,0	1,5	2,0	2,0	1,5	$4,5^{2)}$ (1,5) <sup>3)</sup>
	16x130	130	2,5	2,5	1,5	2,5	2,5	1,5	$4,5^{2)}$ (1,5) <sup>3)</sup>
M12 / M16 / IG-M8 / IG-M10	20x85	85							
	20x130	130	6,0	5,5	4,0	6,0	5,5	4,0	$4,5^{2)}$ (1,5) <sup>3)</sup>
	20x200	200							

1) Values are valid for  $C_{cr}$  and  $C_{min}$

2)  $V_{Rk,c,II} = V_{Rk,b}$  valid for shear load parallel to free edge

3)  $V_{Rk,c,\perp} = V_{Rk,b}$  (values in brackets) valid for shear load in direction to free edge

4) The values are valid for steel 5.6 or higher. For steel 4.6 and 4.8 multiply  $V_{Rk,b}$  by 0,8

**Injection System VMU plus for masonry**

Performances - Calcium silicate hollow brick KSL-3DF  
Group factor, Characteristic values of resistance

**Annex C10**

**Brick type: Calcium silicate hollow brick KSL-3DF**

**Table C24: Characteristic values of resistance under tension and shear loads (continue)**

Anchor size	Sleeve	Effective anchorage depth	Characteristic resistance						
			Use category						
			d/d			w/d; w/w			d/d; w/d; w/w
			40°C/24°C	80°C/50°C	120°C/72°C	40°C/24°C	80°C/50°C	120°C/72°C	All temperature ranges
$h_{ef}$	$N_{Rk,b} = N_{Rk,p}^{1)}$			$N_{Rk,b} = N_{Rk,p}^{1)}$			$V_{Rk,b}^{4)}$		
		[mm]	[kN]						
<b>Compressive strength <math>f_b \geq 14 \text{ N/mm}^2</math></b>									
M8	12x80	80	2,5	2,5	1,5	2,0	2,0	1,5	3,5 <sup>2)</sup> (1,5) <sup>3)</sup>
M8 / M10 / IG-M6	16x85	85	2,5	2,5	1,5	2,5	2,5	1,5	6,0 <sup>2)</sup> (2,0) <sup>3)</sup>
	16x130	130	2,5	2,5	2,0	2,5	2,5	2,0	6,0 <sup>2)</sup> (2,0) <sup>3)</sup>
M12 / M16 / IG-M8 / IG-M10	20x85	85	6,5	6,0	4,5	6,5	6,0	4,5	6,0 <sup>2)</sup> (2,0) <sup>3)</sup>
	20x130	130							
	20x200	200							

1) Values are valid for  $c_{cr}$  and  $c_{min}$

2)  $V_{Rk,c,II} = V_{Rk,b}$  valid for shear load parallel to free edge

3)  $V_{Rk,c,I} = V_{Rk,b}$  (values in brackets) valid for shear load in direction to free edge

4) The values are valid for steel 5.6 or higher. For steel 4.6 and 4.8 multiply  $V_{Rk,b}$  by 0,8

**Table C25: Displacements**

Anchor size	Sleeve	$h_{ef}$	N	$\delta_N / N$	$\delta_{N0}$	$\delta_{N\infty}$	V	$\delta_{V0}$	$\delta_{V\infty}$
		[mm]	[kN]	[mm/kN]	[mm]	[mm]	[kN]	[mm]	[mm]
M8	12x80	80	0,71	0,90	0,64	1,29	1,0	1,0	1,50
M8 / M10 / IG-M6	16x85	85							
		16x130	130	1,86	1,67	3,34	1,7	1,9	2,85
M12 / M16 / IG-M8 / IG-M10	20x85	85							
		20x130	130						
	20x200	200							


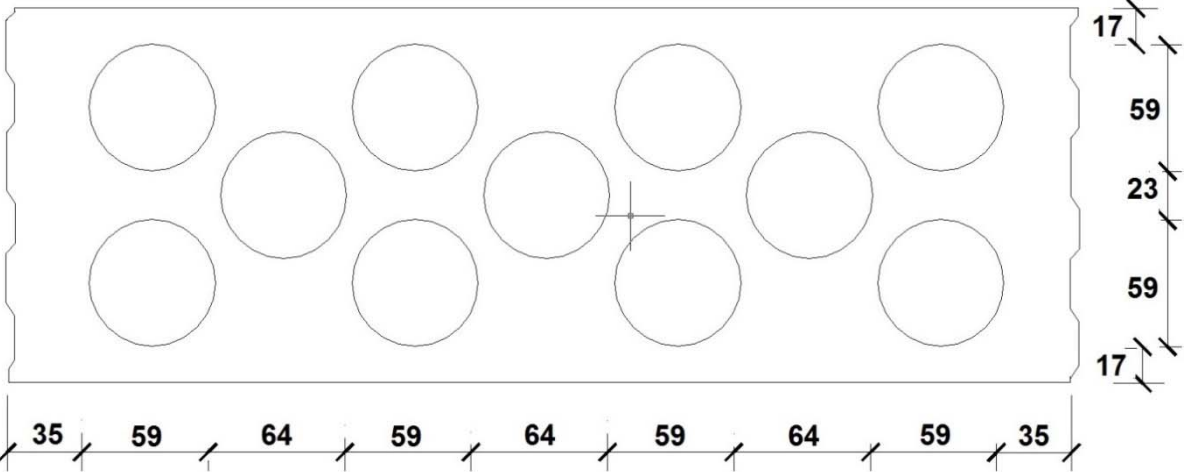
**Injection System VMU plus for masonry**

**Performance - Calcium silicate hollow brick KSL-3DF**  
Characteristic values of resistance, Displacements

**Annex C11**

**Brick type: Calcium silicate hollow brick KSL-12DF**

**Table C26: Description of the brick**

<b>Brick type</b>	Calcium silicate hollow brick KSL-12DF		
Bulk density	$\rho$ [kg/dm <sup>3</sup> ]	1,4	
Compressive strength	$f_b \geq$ [N/mm <sup>2</sup> ]	10, 12 or 16	
Code	EN 771-2		
Producer (country code)	e.g. Wemding (DE)		
Brick dimensions	[mm]	498 x 175 x 238	
Drilling method	Rotary		
			

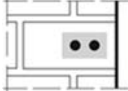
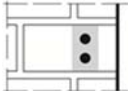
**Table C27: Spacing and edge distances**

Anchor size		All sizes	
Edge distance	$C_{cr}$ [mm]	100 (120) <sup>1)</sup>	
Minimum edge distance	$C_{min}^{2)}$ [mm]	100 (120) <sup>1)</sup>	
Spacing	$S_{cr,II}$ [mm]	498	
	$S_{cr,\perp}$ [mm]	238	
Minimum spacing	$S_{min}$ [mm]	120	

1) Value in brackets for VM-SH 20x85 and VM-SH 20x130

2) For  $V_{Rk,c}$ :  $C_{min}$  according to ETAG 029, Annex C

**Table C28: Group factor for anchor group in case of tension loading**

Configuration		with $c$ [mm] $\geq$	with $s$ [mm] $\geq$			
II: anchors placed parallel to horizontal joint		100	120	$\alpha_{g,N,II}$	[-]	1,0
		$C_{cr}$	498			2,0
⊥: anchors placed perpendicular to horizontal joint		100	120	$\alpha_{g,N,\perp}$		1,0
		$C_{cr}$	238			2,0

**Injection System VMU plus for masonry**

**Performance - Calcium silicate hollow brick KSL-12DF**  
Description of the brick, Spacing and edge distances, Group factor

**Annex C12**

Brick type: Calcium silicate hollow brick KSL-12DF

**Table C29: Group factor for anchor group in case of shear loading parallel to free edge**

Configuration		with c [mm] ≥	with s [mm] ≥			
II: anchors placed parallel to horizontal joint		$C_{cr}$	498	$\alpha_{g,V,II}$	[-]	2,0
I: anchors placed perpendicular to horizontal joint		$C_{cr}$	238	$\alpha_{g,V,I}$		2,0

**Table C30: Group factor for anchor group in case of shear load perpendicular to free edge**

Configuration		with c [mm] ≥	with s [mm] ≥			
II: anchors placed parallel to horizontal joint		$C_{cr}$	498	$\alpha_{g,V,II}$	[-]	2,0
I: anchors placed perpendicular to horizontal joint		$C_{cr}$	238	$\alpha_{g,V,I}$		2,0

**Table C31: Characteristic values of resistance under tension and shear loads**

Anchor size	Sleeve	Effective anchorage depth	Characteristic resistance						
			Use category						
			d/d			w/d; w/w			d/d w/d w/w
			40°C/24°C	80°C/50°C	120°C/72°C	40°C/24°C	80°C/50°C	120°C/72°C	All temperature ranges
		$h_{ef}$	$N_{Rk,b} = N_{Rk,p}^{1)}$			$N_{Rk,b} = N_{Rk,p}^{1)}$			$V_{Rk,b}^{2)3)}$
		[mm]	[kN]						
<b>Compressive strength <math>f_b \geq 10 \text{ N/mm}^2</math></b>									
M8	12x80	80	0,6	0,6	0,4	0,5	0,5	0,4	2,5
M8 / M10 / IG-M6	16x85	85	0,6	0,6	0,4	0,6	0,6	0,4	5,5
	16x130	130	2,5	2,5	2,0	2,5	2,5	2,0	5,5
M12 / M16 / IG-M8 / IG-M10	20x85	85	1,5	1,5	0,9	1,5	1,5	0,9	5,5
	20x130	130	2,5	2,5	2,0	2,5	2,5	2,0	5,5
<b>Compressive strength <math>f_b \geq 12 \text{ N/mm}^2</math></b>									
M8	12x80	80	0,75	0,6	0,5	0,6	0,6	0,4	3,0
M8 / M10 / IG-M6	16x85	85	0,75	0,6	0,5	0,75	0,6	0,5	6,5
	16x130	130	3,0	3,0	2,0	3,0	3,0	2,0	6,5
M12 / M16 / IG-M8 / IG-M10	20x85	85	1,5	1,5	1,2	1,5	1,5	1,2	6,5
	20x130	130	3,0	3,0	2,0	3,0	3,0	2,0	6,5

1) Values are valid for  $C_{cr}$  and  $C_{min}$

2) Calculation of  $V_{Rk,c}$  see ETAG 029, Annex C, except for shear load parallel to free edge with  $c \geq 120 \text{ mm}$ :  $V_{Rk,c,II} = V_{Rk,b}$

3) The values are valid for steel 5.6 or higher. For steel 4.6 and 4.8 multiply  $V_{Rk,b}$  by 0,8

Injection System VMU plus for masonry

Performance - Calcium silicate hollow brick KSL-12DF  
Group factor, Characteristic values of resistance

**Annex C13**

Brick type: Calcium silicate hollow brick KSL-12DF

**Table C32: Characteristic values of resistance under tension and shear loads (continue)**

Anchor size	Sleeve	Effective anchorage depth	Characteristic resistance						
			Use category						
			d/d			w/d; w/w			d/d w/d w/w
			40°C/24°C	80°C/50°C	120°C/72°C	40°C/24°C	80°C/50°C	120°C/72°C	All temperature ranges
$h_{ef}$	$N_{Rk,b} = N_{Rk,p}^{1)}$			$N_{Rk,b} = N_{Rk,p}^{1)}$			$V_{Rk,b}^{2)3)}$		
			[kN]						
			<b>Compressive strength <math>f_b \geq 16 \text{ N/mm}^2</math></b>						
M8	12x80	80	0,9	0,9	0,6	0,75	0,75	0,5	3,5
M8 / M10 / IG-M6	16x85	85	0,9	0,9	0,6	0,9	0,9	0,6	8,0
	16x130	130	4,0	3,5	2,5	4,0	3,5	2,5	8,0
M12 / M16 / IG-M8 / IG-M10	20x85	85	2,0	2,0	1,5	2,0	2,0	1,5	8,0
	20x130	130	4,0	3,5	2,5	4,0	3,5	2,5	8,0

1) Values are valid for  $c_{cr}$  and  $c_{min}$

2) Calculation of  $V_{Rk,c}$  see ETAG 029, Annex C, except for shear load parallel to free edge with  $c \geq 120 \text{ mm}$ :  $V_{Rk,c,II} = V_{Rk,b}$

3) The values are valid for steel 5.6 or higher. For steel 4.6 and 4.8 multiply  $V_{Rk,b}$  by 0,8

**Table C33: Displacements**

Anchor size	Sleeve	$h_{ef}$	N	$\delta_N / N$	$\delta_{N0}$	$\delta_{N\infty}$	V	$\delta_{V0}$	$\delta_{V\infty}$
		[mm]	[kN]	[mm/kN]	[mm]	[mm]	[kN]	[mm]	[mm]
M8	12x80	80	0,26	0,90	0,23	0,46	1,0	1,3	1,95
M8 / M10 / IG-M6	16x85	85							
	16x130	130	1,14		1,03	2,06	2,3	2,5	3,75
M12 / M16 / IG-M8 / IG-M10	20x85	85	0,57		0,51	1,03			
	20x130	130	1,14	1,03	2,06				

Injection System VMU plus for masonry

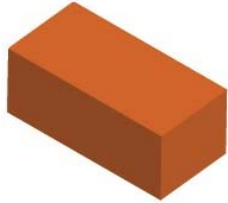
Performance - Calcium silicate hollow brick KSL-12DF  
Characteristic values of resistance (continue), Displacements

**Annex C14**



**Brick type: Clay solid brick Mz-DF**

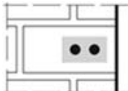
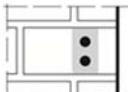
**Table C34: Description of the brick**

Brick type	Clay solid brick Mz-DF		
Bulk density $\rho$ [kg/dm <sup>3</sup> ]		1,6	
Compressive strength $f_b \geq$ [N/mm <sup>2</sup> ]		10, 20 or 28	
Code		EN 771-1	
Producer (country code)		e.g. Unipor (DE)	
Brick dimensions [mm]		240 x 115 x 55	
Drilling method		Hammer	

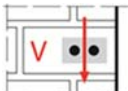
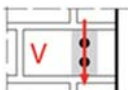
**Table C35: Spacing and edge distances**

Anchor size			Alle Größen
Edge distance	$c_{cr}$	[mm]	$1,5 \cdot h_{ef}$
Minimum edge distance	$c_{min}$	[mm]	60
Spacing	$s_{cr}$	[mm]	$3 \cdot h_{ef}$
Minimum spacing	$s_{min}$	[mm]	120

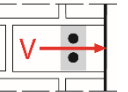

**Table C36: Group factor for anchor group in case of tension loading**

Configuration		with $c$ [mm] $\geq$	with $s$ [mm] $\geq$			
II: anchors placed parallel to horizontal joint		60	120	$\alpha_{g,N,II}$	[-]	0,7
		$1,5 \cdot h_{ef}$	$3 \cdot h_{ef}$			2,0
⊥: anchors placed perpendicular to horizontal joint		60	120	$\alpha_{g,N,\perp}$		0,5
		$1,5 \cdot h_{ef}$	120			1,0
		$1,5 \cdot h_{ef}$	$3 \cdot h_{ef}$		2,0	

**Table C37: Group factor for anchor group in case of shear loading parallel to free edge**

Configuration		with $c$ [mm] $\geq$	with $s$ [mm] $\geq$			
II: anchors placed parallel to horizontal joint		60	120	$\alpha_{g,V,II}$	[-]	0,5
		90	120			1,1
		$1,5 \cdot h_{ef}$	$3 \cdot h_{ef}$			2,0
⊥: anchors placed perpendicular to horizontal joint		60	120	$\alpha_{g,V,\perp}$		0,5
		$1,5 \cdot h_{ef}$	120			1,0
		$1,5 \cdot h_{ef}$	$3 \cdot h_{ef}$			2,0

**Table C38: Group factor for anchor group in case of shear load perpendicular to free edge**

Configuration		with $c$ [mm] $\geq$	with $s$ [mm] $\geq$			
II: anchors placed parallel to horizontal joint		60	120	$\alpha_{g,V,II}$	[-]	0,5
		$1,5 \cdot h_{ef}$	120			1,0
		$1,5 \cdot h_{ef}$	$3 \cdot h_{ef}$			2,0
⊥: anchors placed perpendicular to horizontal joint		60	120	$\alpha_{g,V,\perp}$		0,5
		$1,5 \cdot h_{ef}$	120			1,0
		$1,5 \cdot h_{ef}$	$3 \cdot h_{ef}$			2,0

**Injection System VMU plus for masonry**

**Performance - Clay solid brick Mz-DF**

Description of the brick , Spacing and edge distances, Group factor

**Annex C15**

Brick type: Clay solid brick Mz-DF

**Table C39: Characteristic values of resistance under tension and shear loads**

Anchor size	Sleeve	Effective Anchorage depth	Characteristic resistance			
			Use category			
			d/d w/d w/w			d/d w/d w/w
			40°C/24°C	80°C/50°C	120°C/72°C	All temperature ranges
h <sub>ef</sub> [mm]		N <sub>Rk,b</sub> = N <sub>Rk,p</sub> <sup>1)</sup>			V <sub>Rk,b</sub> <sup>2)3)</sup>	
[kN]						
<b>Compressive strength f<sub>b</sub> ≥ 10 N/mm<sup>2</sup></b>						
M8	-	80	3,5 (1,5)	3,5 (1,5)	2,5 (1,2)	3,5 (1,2)
M10 / IG-M6	-	90	3,5 (1,5)	3,5 (1,5)	3,0 (1,5)	3,5 (1,2)
M12 / IG-M8	-	100	4,0 (2,0)	4,0 (2,0)	3,5 (1,5)	3,5 (1,2)
M16 / IG-M10	-	100	4,0 (2,0)	4,0 (2,0)	3,5 (1,5)	5,5 (1,5)
M8	12x80	80	3,5 (1,5)	3,5 (1,5)	3,0 (1,2)	3,5 (1,2)
M8 / M10 / IG-M6	16x85	85	3,5 (1,5)	3,5 (1,5)	3,0 (1,5)	3,5 (1,2)
	16x130	130				
M12 / M16 / IG-M8 / IG-M10	20x85	85				
	20x130	130				
	20x200	200				
<b>Compressive strength f<sub>b</sub> ≥ 20 N/mm<sup>2</sup></b>						
M8	-	80	4,5 (2,5)	4,5 (2,5)	4,0 (2,0)	5,0 (1,5)
M10 / IG-M6	-	90	5,5 (2,5)	5,5 (2,5)	4,5 (2,0)	5,0 (1,5)
M12 / IG-M8	-	100	6,0 (3,0)	6,0 (3,0)	5,0 (2,5)	5,0 (1,5)
M16 / IG-M10	-	100	6,0 (3,0)	6,0 (3,0)	5,0 (2,5)	8,0 (2,5)
M8	12x80	80	4,5 (2,5)	4,5 (2,5)	4,0 (2,0)	5,0 (1,5)
M8 / M10 / IG-M6	16x85	85	5,0 (2,5)	5,0 (2,5)	4,0 (2,0)	5,0 (1,5)
	16x130	130				
M12 / M16 / IG-M8 / IG-M10	20x85	85				
	20x130	130				
	20x200	200				
<b>Compressive strength f<sub>b</sub> ≥ 28 N/mm<sup>2</sup></b>						
M8	-	80	5,5 (2,5)	5,5 (2,5)	4,5 (2,5)	5,5 (2,0)
M10 / IG-M6	-	90	6,0 (3,0)	6,0 (3,0)	5,0 (2,5)	5,5 (2,0)
M12 / IG-M8	-	100	7,0 (3,5)	7,0 (3,5)	6,0 (3,0)	5,5 (2,0)
M16 / IG-M10	-	100	7,0 (3,5)	7,0 (3,5)	6,0 (3,0)	9,0 (3,0)
M8	12x80	80	5,5 (2,5)	5,5 (2,5)	4,5 (2,5)	5,5 (2,0)
M8 / M10 / IG-M6	16x85	85	6,0 (3,0)	6,0 (3,0)	5,0 (2,5)	5,5 (2,0)
	16x130	130				
M12 / M16 / IG-M8 / IG-M10	20x85	85				
	20x130	130				
	20x200	200				

1) Values are valid for c<sub>cr</sub>, values in brackets are valid for single anchors with c<sub>min</sub>

2) For c<sub>cr</sub> calculation of V<sub>Rk,c</sub> see ETAG 029, Annex C; for c<sub>min</sub> values in brackets V<sub>Rk,c</sub> = V<sub>Rk,b</sub>

3) The values are valid for steel 5.6 or higher. For steel 4.6 and 4.8 multiply V<sub>Rk,b</sub> by 0,8.

**Injection System VMU plus for masonry**

**Performance - Clay solid brick Mz-DF**  
Characteristic values of resistance

**Annex C16**

Brick type: Clay solid brick Mz-DF

**Table C40: Displacements**

Anchor size	Sleeve	$h_{ef}$	N	$\delta_N / N$	$\delta_{N0}$	$\delta_{N\infty}$	V	$\delta_{V0}$	$\delta_{V\infty}$	
		[mm]	[kN]	[mm/kN]	[mm]	[mm]	[kN]	[mm]	[mm]	
M8	-	80	1,3	0,15	0,19	0,39	1,9	1,00	1,50	
M10 / IG-M6	-	90	1,6		0,24	0,47				
M12 / IG-M8	-	100	1,7		0,26	0,51				2,9
M16 / IG-M10	-	100								
M8	12x80	80	1,3		0,19	0,39	1,9			
M8 / M10 / IG-M6	16x85	85								
	16x130	130								
M12 / M16 / IG-M8 / IG-M10	20x85	85								
	20x130	130								
	20x200	200								

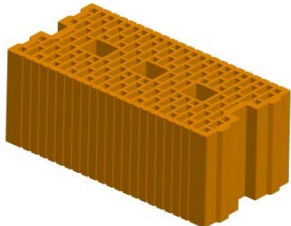
Injection System VMU plus for masonry

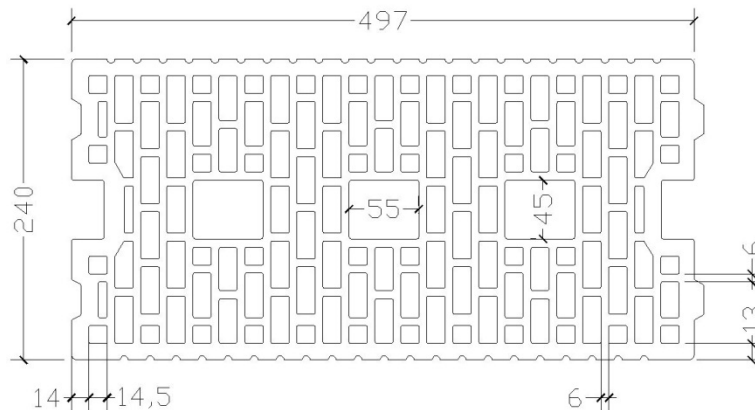
Performance - Clay solid brick Mz-DF  
Displacements

**Annex C17**

**Brick type: Clay hollow brick HLz-16-DF**

**Table C41: Description of the brick**

<b>Brick type</b>	Clay hollow brick HLz-16-DF		
Bulk density $\rho$ [kg/dm <sup>3</sup> ]		0,8	
Compressive strength $f_b \geq$ [N/mm <sup>2</sup> ]		6, 8, 12 or 14	
Code		EN 771-1	
Producer (country code)		e.g. Unipor (DE)	
Brick dimensions [mm]		497 x 240 x 238	
Drilling method		Rotary	



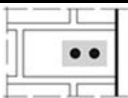
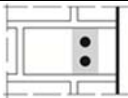
**Table C42: Spacing and edge distances**

Anchor size			All sizes
Edge distance	$C_{cr}$	[mm]	100 (120) <sup>1)</sup>
Minimum edge distance	$C_{min}^{2)}$	[mm]	100 (120) <sup>1)</sup>
Spacing	$S_{cr,  }$	[mm]	497
	$S_{cr,\perp}$	[mm]	238
Minimum spacing	$S_{min}$	[mm]	100

<sup>1)</sup> Value in bracket for VM-SH 20x85; VM-SH 20x130 and VM-SH 20x200

<sup>2)</sup> For  $V_{Rk,c}$ :  $C_{min}$  according to ETAG 029, Annex C

**Table C43: Group factor for anchor group in case of tension loading**

Configuration		with $c$ [mm] $\geq$	with $s$ [mm] $\geq$			
: anchors placed parallel to horizontal joint		$C_{cr}$	100	$\alpha_{g,N,  }$	[-]	1,3
		$C_{cr}$	497			2,0
⊥: anchors placed perpendicular to horizontal joint		$C_{cr}$	100	$\alpha_{g,N,\perp}$	[-]	1,1
		$C_{cr}$	238			2,0

**Injection System VMU plus for masonry**

**Performance - Clay hollow brick HLz-16DF**

Description of the brick, Spacing and edge distances, Group factor

**Annex C18**

Brick type: Clay hollow brick HLz-16-DF

**Table C44: Group factor for anchor group in case of shear loading parallel to free edge**

Configuration		with c [mm] ≥	with s [mm] ≥			
: anchors placed parallel to horizontal joint		$C_{cr}$	497	$\alpha_{g,V,  }$	[-]	2,0
⊥: anchors placed perpendicular to horizontal joint		$C_{cr}$	238	$\alpha_{g,V,\perp}$		2,0

**Table C45: Group factor for anchor group in case of shear load perpendicular to free edge**

Configuration		with c [mm] ≥	with s [mm] ≥			
: anchors placed parallel to horizontal joint		$C_{cr}$	497	$\alpha_{g,V,  }$	[-]	2,0
⊥: anchors placed perpendicular to horizontal joint		$C_{cr}$	238	$\alpha_{g,V,\perp}$		2,0

**Table C46: Characteristic values of resistance under tension and shear loads**

Anchor size	Sleeve	Effective Anchorage depth	Characteristic resistance			
			Use category			
			d/d			d/d
			40°C/24°C	80°C/50°C	120°C/72°C	All temperature ranges
		$h_{ef}$	$N_{Rk,b} = N_{Rk,p}^{1)}$			$V_{Rk,b}^{2)3)}$
		[mm]	[kN]			[kN]
<b>Compressive strength <math>f_b \geq 6 \text{ N/mm}^2</math></b>						
M8	12x80	80	2,5	2,5	2,0	2,5
M8 / M10/ IG-M6	16x85	85	2,5	2,5	2,0	4,5
	16x130	130	3,5	3,5	3,0	4,5
M12 / M16 / IG-M8 / IG-M10	20x85	85	2,5	2,5	2,0	5,0
	20x130	130	3,5	3,5	3,0	6,0
	20x200	200	3,5	3,5	3,0	6,0
<b>Compressive strength <math>f_b \geq 8 \text{ N/mm}^2</math></b>						
M8	12x80	80	3,0	3,0	2,5	3,0
M8 / M10/ IG-M6	16x85	85	3,0	3,0	2,5	5,5
	16x130	130	4,5	4,5	3,5	5,5
M12 / M16 / IG-M8 / IG-M10	20x85	85	3,0	3,0	2,5	6,0
	20x130	130	4,5	4,5	3,5	7,0
	20x200	200	4,5	4,5	3,5	7,0

1) Values are valid for  $c_{cr}$  and  $c_{min}$

2) Calculation of  $V_{Rk,c}$  see ETAG 029, Annex C, except for shear load parallel to free edge with  $c \geq 125 \text{ mm}$ :  $V_{Rk,c,||} = V_{Rk,b}$

3) The values are valid for steel 5.6 or higher. For steel 4.6 and 4.8 multiply  $V_{Rk,b}$  by 0,8

**Injection System VMU plus for masonry**

**Performance - Clay hollow brick HLz-16DF**  
Group factor, Characteristic values of resistance

**Annex C19**

Brick type: Clay hollow brick HLz-16DF

**Table C47: Characteristic values of resistance under tension and shear loads (continue)**

Anchor size	Sleeve	Effective Anchorage depth	Characteristic resistance			
			Use category			
			d/d w/d w/w			d/d w/d w/w
			40°C/24°C	80°C/50°C	120°C/72°C	All temperature ranges
$h_{ef}$	$N_{Rk,b} = N_{Rk,p}^{1)}$			$V_{Rk,b}^{2)3)}$		
[mm]	[kN]			[kN]		
<b>Compressive strength <math>f_b \geq 12 \text{ N/mm}^2</math></b>						
M8	12x80	80	3,5	3,5	3,0	4,0
M8 / M10/ IG-M6	16x85	85	3,5	3,5	3,0	6,5
	16x130	130	5,0	5,0	4,5	6,5
M12 / M16 / IG-M8 / IG-M10	20x85	85	3,5	3,5	3,0	7,0
	20x130	130	5,0	5,0	4,5	9,0
	20x200	200	5,0	5,0	4,5	9,0
<b>Compressive strength <math>f_b \geq 14 \text{ N/mm}^2</math></b>						
M8	12x80	80	4,0	4,0	3,0	4,0
M8 / M10/ IG-M6	16x85	85	4,0	4,0	3,0	6,5
	16x130	130	5,5	5,5	4,5	6,5
M12 / M16 / IG-M8 / IG-M10	20x85	85	4,0	4,0	3,0	7,0
	20x130	130	5,5	5,5	4,5	9,0
	20x200	200	5,5	5,5	4,5	9,0

1) Values are valid for  $c_{cr}$  and  $c_{min}$

2) Calculation of  $V_{Rk,c}$  see ETAG 029, Annex C, except for shear load parallel to free edge with  $c \geq 125 \text{ mm}$ :  $V_{Rk,c,II} = V_{Rk,b}$

3) The values are valid for steel 5.6 or higher. For steel 4.6 and 4.8 multiply  $V_{Rk,b}$  by 0,8

**Table C48: Displacements**

Anchor size	Sleeve	$h_{ef}$	N	$\delta_N / N$	$\delta_{N0}$	$\delta_{N\infty}$	V	$\delta_{V0}$	$\delta_{V\infty}$
		[mm]	[kN]	[mm/kN]	[mm]	[mm]	[kN]	[mm]	[mm]
M8	12x80	80	1,14	0,10	0,11	0,23	1,10	1,20	1,80
M8 / M10/ IG-M6	16x85	85							
	16x130	130	1,57						
M12 / M16 / IG-M8 / IG-M10	20x85	85	1,14		0,11	0,23	1,86	1,50	2,25
	20x130	130	1,57		0,16	0,31	2,57	2,10	3,15
	20x200	200							

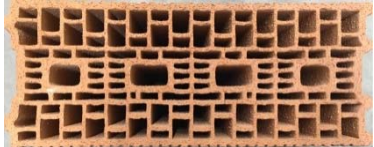
Injection System VMU plus for masonry

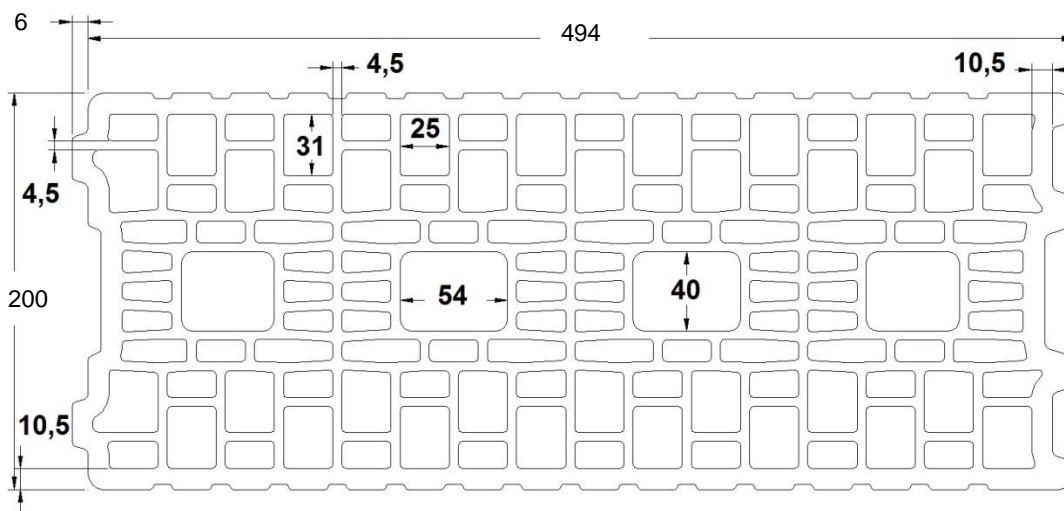
Performance - Clay hollow brick HLz-16DF  
Characteristic values of resistance (continue), Displacements

**Annex C20**

**Brick type: Clay hollow brick Porotherm Homebric**

**Table C49: Description of the brick**

<b>Brick type</b>	Clay hollow brick Porotherm Homebric		
Bulk density	$\rho$ [kg/dm <sup>3</sup> ]	0,7	
Compressive strength	$f_b \geq$ [N/mm <sup>2</sup> ]	4, 6 or 10	
Code	EN 771-1		
Producer (country code)	e.g. Wienerberger (FR)		
Brick dimensions	[mm]	500 x 200 x 299	
Drilling method	Rotary		



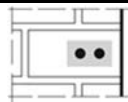
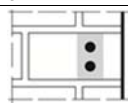
**Table C50: Spacing and edge distances**

Anchor size		All sizes	
Edge distance	$C_{cr}$ [mm]	100 (120) <sup>1)</sup>	
Minimum edge distance	$C_{min}^{2)}$ [mm]	100 (120) <sup>1)</sup>	
Spacing	$S_{cr,II}$ [mm]	500	
	$S_{cr,\perp}$ [mm]	299	
Minimum spacing	$S_{min}$ [mm]	100	

1) Value in brackets for VM-SH 20x85 and VM-SH 20x130

2) For  $V_{Rk,c}$ :  $C_{min}$  according to ETAG 029, Annex C

**Table C51: Group factor for anchor group in case of tension loading**

Configuration		with $c$ [mm] $\geq$	with $s$ [mm] $\geq$			
II: anchors placed parallel to horizontal joint		200	100	$\alpha_{g,N,II}$	[-]	2,0
		$C_{cr}$	500			2,0
⊥: anchors placed perpendicular to horizontal joint		200	100	$\alpha_{g,N,\perp}$		1,2
		$C_{cr}$	299			2,0

**Injection System VMU plus for masonry**

**Performance - Clay hollow brick Porotherm Homebric**  
Description of the brick, Spacing and edge distances, Group factor

**Annex C21**

Brick type: Clay hollow brick Porotherm Homebric

**Table C52: Group factor for anchor group in case of shear loading parallel to free edge**

Configuration		with c [mm] ≥	with s [mm] ≥			
II: anchors placed parallel to horizontal joint		$C_{cr}$	500	$\alpha_{g,V,II}$	[-]	2,0
I: anchors placed perpendicular to horizontal joint		$C_{cr}$	299	$\alpha_{g,V,I}$		2,0

**Table C53: Group factor for anchor group in case of shear load perpendicular to free edge**

Configuration		with c [mm] ≥	with s [mm] ≥			
II: anchors placed parallel to horizontal joint		$C_{cr}$	500	$\alpha_{g,V,II}$	[-]	2,0
I: anchors placed perpendicular to horizontal joint		$C_{cr}$	299	$\alpha_{g,V,I}$		2,0

**Table C54: Characteristic values of resistance under tension and shear loads**

Anchor size	Sleeve	Effective Anchorage depth	Characteristic resistance			
			Use category			
			d/d w/d w/w			d/d w/d w/w
			40°C/24°C	80°C/50°C	120°C/72°C	All temperature ranges
$h_{ef}$	$N_{Rk,b} = N_{Rk,p}^{1)}$			$V_{Rk,b}^{2)3)}$		
[mm]	[kN]			[kN]		
<b>Compressive strength <math>f_b \geq 4 \text{ N/mm}^2</math></b>						
M8	12x80	80	0,9	0,9	0,75	2,0
M8 / M10 / IG-M6	16x85	85	0,9	0,9	0,75	2,0
	16x130	130	1,2	1,2	0,9	2,0
M12 / M16 / IG-M8 / IG-M10	20x85	85	0,9	0,9	0,75	2,5
	20x130	130	1,2	1,2	0,9	2,5
<b>Compressive strength <math>f_b \geq 6 \text{ N/mm}^2</math></b>						
M8	12x80	80	0,9	0,9	0,9	2,5
M8 / M10 / IG-M6	16x85	85	0,9	0,9	0,9	2,5
	16x130	130	1,2	1,2	1,2	2,5
M12 / M16 / IG-M8 / IG-M10	20x85	85	0,9	0,9	0,9	3,0
	20x130	130	1,2	1,2	1,2	3,0

1) Values are valid for  $c_{cr}$  and  $c_{min}$

2) Calculation of  $V_{Rk,c}$  see ETAG 029, Annex C, except for shear load parallel to free edge with  $c \geq 200 \text{ mm}$ :  $V_{Rk,c,II} = V_{Rk,b}$

3) The values are valid for steel 5.6 or higher. For steel 4.6 and 4.8 multiply  $V_{Rk,b}$  by 0,8

**Injection System VMU plus for masonry**

**Performance - Clay hollow brick Porotherm Homebric**  
Group factor, Characteristic values of resistance

**Annex C22**



Brick type: Clay hollow brick Porotherm Homebric

**Table C55: Characteristic values of resistance under tension and shear loads (continue)**

Anchor size	Sleeve	Effective Anchorage depth	Characteristic resistance			
			Use category			
			d/d w/d w/w			d/d w/d w/w
			40°C/24°C	80°C/50°C	120°C/72°C	All temperature ranges
$h_{ef}$ [mm]	$N_{Rk,b} = N_{Rk,p}^{1)}$ [kN]			$V_{Rk,b}^{2)3)}$ [kN]		
<b>Compressive strength <math>f_b \geq 10 \text{ N/mm}^2</math></b>						
M8	12x80	80	1,2	1,2	1,2	3,0
M8 / M10/ IG-M6	16x85	85	1,2	1,2	1,2	3,0
	16x130	130	1,5	1,5	1,5	3,5
M12 / M16 / IG-M8 / IG-M10	20x85	85	1,2	1,2	1,2	4,0
	20x130	130	1,5	1,5	1,5	4,0

1) Values are valid for  $c_{cr}$  and  $c_{min}$

2) Calculation of  $V_{Rk,c}$  see ETAG 029, Annex C, except for shear load parallel to free edge with  $c \geq 200 \text{ mm}$ :  $V_{Rk,c,II} = V_{Rk,b}$

3) The values are valid for steel 5.6 or higher. For steel 4.6 and 4.8 multiply  $V_{Rk,b}$  by 0,8

**Table C56: Displacements**

Anchor size	Sleeve	$h_{ef}$	N	$\delta_N / N$	$\delta_{N0}$	$\delta_{N\infty}$	V	$\delta_{v0}$	$\delta_{v\infty}$
		[mm]	[kN]	[mm/kN]	[mm]	[mm]	[kN]	[mm]	[mm]
M8	12x80	80	0,34	0,80	0,27	0,55	0,9	1,20	1,80
M8 / M10/ IG-M6	16x85	85					0,9		
	16x130	130	0,43		0,34	0,69	1,0		
M12 / M16 / IG-M8 / IG-M10	20x85	85	0,34		0,27	0,55	1,14		
	20x130	130	0,43	0,34	0,69				

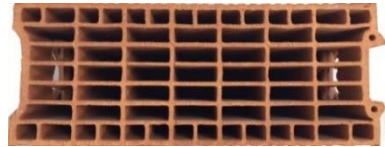
Injection System VMU plus for masonry

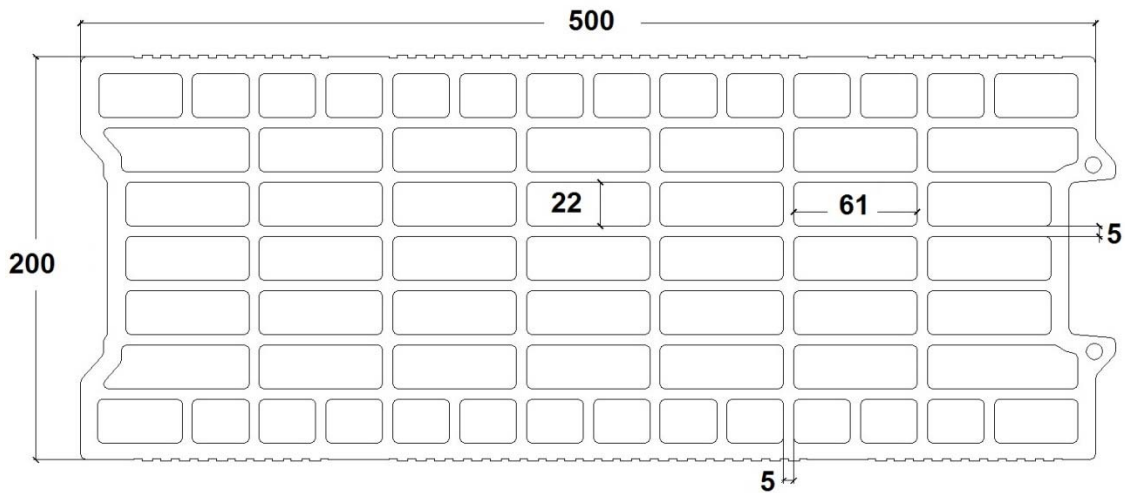
Performance - Clay hollow brick Porotherm Homebric  
Characteristic values of resistance (continue), Displacements

**Annex C23**

**Brick type: Clay hollow brick BGV Thermo**

**Table C57: Description of the brick**

<b>Brick type</b>	Clay hollow brick BGV Thermo		
Bulk density	$\rho$ [kg/dm <sup>3</sup> ]	0,6	
Compressive strength	$f_b \geq$ [N/mm <sup>2</sup> ]	4, 6 or 10	
Code	EN 771-1		
Producer (country code)	e.g. Leroux (FR)		
Brick dimensions	[mm]	500 x 200 x 314	
Drilling method	Rotary		



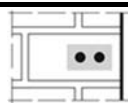
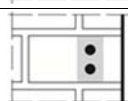
**Table C58: Spacing and edge distances**

Anchor size			All sizes
Edge distance	$C_{cr}$	[mm]	100 (120) <sup>1)</sup>
Minimum edge distance	$C_{min}$ <sup>2)</sup>	[mm]	100 (120) <sup>1)</sup>
Spacing	$S_{cr,  }$	[mm]	500
	$S_{cr,\perp}$	[mm]	314
Minimum spacing	$S_{min}$	[mm]	100

<sup>1)</sup> Values in brackets for VM-SH 20x85 and VM-SH 20x130

<sup>2)</sup> For  $V_{Rk,c}$ :  $C_{min}$  according to ETAG 029, Annex C

**Table C59: Group factor for anchor group in case of tension loading**

Configuration		with $c$ [mm] $\geq$	with $s$ [mm] $\geq$			
: anchors placed parallel to horizontal joint		200	100	$\alpha_{g,N,  }$	[-]	1,7
		$C_{cr}$	500			2,0
$\perp$ : anchors placed perpendicular to horizontal joint		200	100	$\alpha_{g,N,\perp}$	[-]	1,1
		$C_{cr}$	314			2,0

**Injection System VMU plus for masonry**

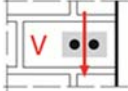
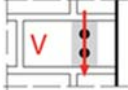
**Performance - Clay hollow brick BGV Thermo**

Description of the brick, Spacing and edge distances, Group factor

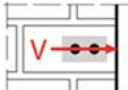
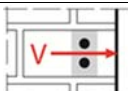
**Annex C24**

**Brick type: Clay hollow brick BGV Thermo**

**Table C60: Group factor for anchor group in case of shear loading parallel to free edge**

Configuration		with $c$ [mm] $\geq$	with $s$ [mm] $\geq$			
: anchors placed parallel to horizontal joint		$C_{cr}$	500	$\alpha_{g,V,  }$	[-]	2,0
⊥: anchors placed perpendicular to horizontal joint		$C_{cr}$	314	$\alpha_{g,V,\perp}$		2,0

**Table C61: Group factor for anchor group in case of shear load perpendicular to free edge**

Configuration		with $c$ [mm] $\geq$	with $s$ [mm] $\geq$			
: anchors placed parallel to horizontal joint		$C_{cr}$	500	$\alpha_{g,V,  }$	[-]	2,0
⊥: anchors placed perpendicular to horizontal joint		$C_{cr}$	314	$\alpha_{g,V,\perp}$		2,0

Injection System VMU plus for masonry

Performance - Clay hollow brick BGV Thermo  
Group factor

**Annex C25**

Brick type: Clay hollow brick BGV Thermo

**Table C62: Characteristic values of resistance under tension and shear loads**

Anchor size	Sleeve	Effective Anchorage depth	Characteristic resistance			
			Use category			
			d/d w/d w/w			d/d w/d w/w
			40°C/24°C	80°C/50°C	120°C/72°C	All temperature ranges
$h_{ef}$ [mm]	$N_{Rk,b} = N_{Rk,p}^{1)}$ [kN]			$V_{Rk,b}^{2)3)}$ [kN]		
<b>Compressive strength <math>f_b \geq 4 \text{ N/mm}^2</math></b>						
M8	12x80	80	0,6	0,6	0,6	2,0
M8 / M10/ IG-M6	16x85	85	0,6	0,6	0,6	2,0
	16x130	130	1,2	1,2	0,9	2,5
M12 / M16 / IG-M8 / IG-M10	20x85	85	0,6	0,6	0,6	2,5
	20x130	130	1,2	1,2	0,9	2,5
<b>Compressive strength <math>f_b \geq 6 \text{ N/mm}^2</math></b>						
M8	12x80	80	0,9	0,9	0,75	2,5
M8 / M10/ IG-M6	16x85	85	0,9	0,9	0,75	2,5
	16x130	130	1,5	1,5	1,2	3,0
M12 / M16 / IG-M8 / IG-M10	20x85	85	0,9	0,9	0,75	3,0
	20x130	130	1,5	1,5	1,2	3,0
<b>Compressive strength <math>f_b \geq 10 \text{ N/mm}^2</math></b>						
M8	12x80	80	0,9	0,9	0,9	3,5
M8 / M10/ IG-M6	16x85	85	0,9	0,9	0,9	3,5
	16x130	130	2,0	2,0	1,5	4,0
M12 / M16 / IG-M8 / IG-M10	20x85	85	0,9	0,9	0,9	4,0
	20x130	130	2,0	2,0	1,5	4,0

1) Values are valid for  $c_{cr}$  and  $c_{min}$

2) Calculation of  $V_{Rk,c}$  see ETAG 029, Annex C, except for shear load parallel to free edge with  $c \geq 250 \text{ mm}$ :  $V_{Rk,c,II} = V_{Rk,b}$

3) The values are valid for steel 5.6 or higher. For steel 4.6 and 4.8 multiply  $V_{Rk,b}$  by 0,8

**Table C63: Displacements**

Anchor size	Sleeve	$h_{ef}$	N	$\delta_N / N$	$\delta_{N0}$	$\delta_{N\infty}$	V	$\delta_{V0}$	$\delta_{V\infty}$
		[mm]	[kN]	[mm/kN]	[mm]	[mm]	[kN]	[mm]	[mm]
M8	12x80	80	0,26	0,80	0,21	0,41	0,7	1,00	1,50
M8 / M10/ IG-M6	16x85	85			0,34	0,69	0,86		
	16x130	130	0,43		0,69				
M12 / M16 / IG-M8 / IG-M10	20x85	85	0,26		0,21	0,41			
	20x130	130	0,43	0,34	0,69				


Injection System VMU plus for masonry

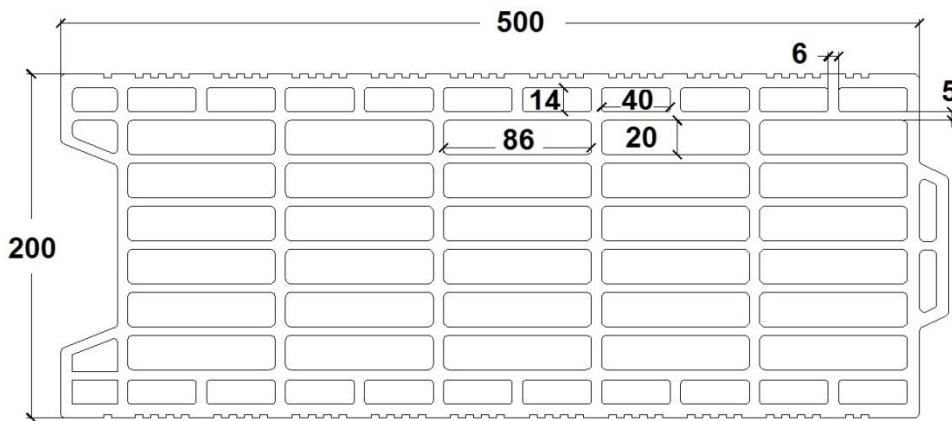
Performance - Clay hollow brick BGV Thermo  
Characteristic values of resistance, Displacements

**Annex C26**

**Brick type: Clay hollow brick Calibric R+**

**Table C64: Description of the brick**

<b>Brick type</b>	Clay hollow brick Calibric R+		
Bulk density	$\rho$ [kg/dm <sup>3</sup> ]	0,6	
Compressive strength	$f_b \geq$ [N/mm <sup>2</sup> ]	6, 9 or 12	
Code	EN 771-1		
Producer (country code)	e.g. Terreal (FR)		
Brick dimensions	[mm]	500 x 200 x 314	
Drilling method	Rotary		



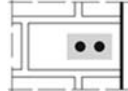
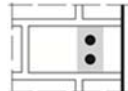
**Table C65: Spacing and edge distances**

Anchor size			All sizes
Edge distance	$C_{cr}$	[mm]	100 (120) <sup>1)</sup>
Minimum edge distance	$C_{min}^{2)}$	[mm]	100 (120) <sup>1)</sup>
Spacing	$S_{cr,II}$	[mm]	500
	$S_{cr,\perp}$	[mm]	314
Minimum spacing	$S_{min}$	[mm]	100

<sup>1)</sup> Value in brackets for VM-SH 20x85 and VM-SH 20x130

<sup>2)</sup> For  $V_{Rk,c}$ :  $C_{min}$  according to ETAG 029, Annex C

**Table C66: Group factor for anchor group in case of tension loading**

Configuration		with $c$ [mm] $\geq$	with $s$ [mm] $\geq$			
II: anchors placed parallel to horizontal joint		175	100	$\alpha_{g,N,II}$	[-]	1,7
		$C_{cr}$	500			2,0
$\perp$ : anchors placed perpendicular to horizontal joint		175	100	$\alpha_{g,N,\perp}$		1,0
		$C_{cr}$	314			2,0

**Injection System VMU plus for masonry**

**Performance - Clay hollow brick Calibric R+**

Description of the brick, Spacing and edge distances, Group factor

**Annex C27**

Brick type: Clay hollow brick Calibric R+

**Table C67: Group factor for anchor group in case of shear loading parallel to free edge**

Configuration		with c [mm] ≥	with s [mm] ≥			
II: anchors placed parallel to horizontal joint		$C_{cr}$	500	$\alpha_{g,V,II}$	[-]	2,0
I: anchors placed perpendicular to horizontal joint		$C_{cr}$	314	$\alpha_{g,V,I}$		2,0

**Table C68: Group factor for anchor group in case of shear load perpendicular to free edge**

Configuration		with c [mm] ≥	with s [mm] ≥			
II: anchors placed parallel to horizontal joint		$C_{cr}$	500	$\alpha_{g,V,II}$	[-]	2,0
I: anchors placed perpendicular to horizontal joint		$C_{cr}$	314	$\alpha_{g,V,I}$		2,0

**Table C69: Characteristic values of resistance under tension and shear loads**

Anchor size	Sleeve	Effective Anchorage depth	Characteristic resistance			
			Use category			
			d/d w/d w/w			d/d w/d w/w
			40°C/24°C	80°C/50°C	120°C/72°C	All temperature ranges
$h_{ef}$	$N_{Rk,b} = N_{Rk,p}^{1)}$			$V_{Rk,b}^{2)3)}$		
[mm]	[kN]			[kN]		
<b>Compressive strength <math>f_b \geq 6 \text{ N/mm}^2</math></b>						
M8	12x80	80	0,9	0,9	0,75	3,0
M8 / M10/ IG-M6	16x85	85	0,9	0,9	0,75	4,0
	16x130	130	1,2	1,2	0,9	4,0
M12 / M16 / IG-M8 / IG-M10	20x85	85	0,9	0,9	0,75	6,0
	20x130	130	1,2	1,2	0,9	6,0
<b>Compressive strength <math>f_b \geq 9 \text{ N/mm}^2</math></b>						
M8	12x80	80	1,2	1,2	0,9	3,5
M8 / M10/ IG-M6	16x85	85	1,2	1,2	0,9	5,0
	16x130	130	1,5	1,5	1,2	5,0
M12 / M16 / IG-M8 / IG-M10	20x85	85	1,2	1,2	0,9	7,5
	20x130	130	1,5	1,5	1,2	7,5

1) Values are valid for  $c_{cr}$  and  $c_{min}$

2) Calculation of  $V_{Rk,c}$  see ETAG 029, Annex C, except for shear load parallel to free edge with  $c \geq 250 \text{ mm}$ :  $V_{Rk,c,II} = V_{Rk,b}$

3) The values are valid for steel 5.6 or higher. For steel 4.6 and 4.8 multiply  $V_{Rk,b}$  by 0,8

Injection System VMU plus for masonry

Performance - Clay hollow brick Calibric R+  
Group factor, Characteristic values of resistance

Annex C28

Brick type: Clay hollow brick Calibric R+

**Table C70: Characteristic values of resistance under tension and shear load (continue)**

Anchor size	Sleeve	Effective Anchorage depth	Characteristic resistance			
			Use category			
			d/d w/d w/w			d/d w/d w/w
			40°C/24°C	80°C/50°C	120°C/72°C	All temperature ranges
$h_{ef}$	$N_{Rk,b} = N_{Rk,p}^{1)}$			$V_{Rk,b}^{2)3)}$		
[mm]	[kN]			[kN]		
<b>Compressive strength <math>f_b \geq 12 \text{ N/mm}^2</math></b>						
M8	12x80	80	1,2	1,2	0,9	4,0
M8 / M10/ IG-M6	16x85	85	1,2	1,2	0,9	5,5
	16x130	130	1,5	1,5	1,2	5,5
M12 / M16 / IG-M8 / IG-M10	20x85	85	1,2	1,2	0,9	8,5
	20x130	130	1,5	1,5	1,2	8,5

1) Values are valid for  $c_{cr}$  and  $c_{min}$

2) Calculation of  $V_{Rk,c}$  see ETAG 029, Annex C, except for shear load parallel to free edge with  $c \geq 250 \text{ mm}$ :  $V_{Rk,c,II} = V_{Rk,b}$

3) The values are valid for steel 5.6 or higher. For steel 4.6 and 4.8 multiply  $V_{Rk,b}$  by 0,8

**Table C71: Displacements**

Anchor size	Sleeve	$h_{ef}$	N	$\delta_N / N$	$\delta_{N0}$	$\delta_{N\infty}$	V	$\delta_{v0}$	$\delta_{v\infty}$
		[mm]	[kN]	[mm/kN]	[mm]	[mm]	[kN]	[mm]	[mm]
M8	12x80	80	0,34	0,80	0,27	0,55	1,0	1,10	1,65
M8 / M10/ IG-M6	16x85	85							
	16x130	130	0,43		0,34	0,69	1,43	2,0	3,0
M12 / M16 / IG-M8 / IG-M10	20x85	85	0,34		0,27	0,55	2,14		
	20x130	130	0,43		0,34	0,69			


Injection System VMU plus for masonry

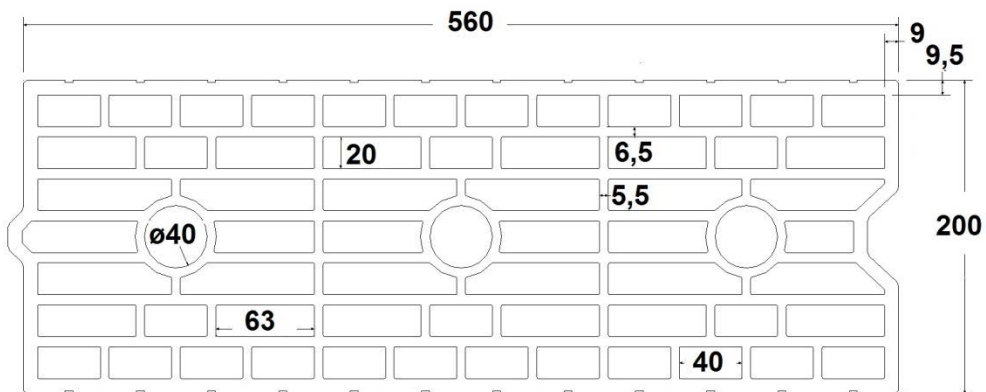
Performance - Clay hollow brick Calibric R+  
Characteristic values of resistance, Displacements

**Annex C29**

**Brick type: Clay hollow brick Urbanbric**

**Table C72: Description of the brick**

<b>Brick type</b>	Clay hollow brick Urbanbric		
Bulk density $\rho$ [kg/dm <sup>3</sup> ]		0,7	
Compressive strength $f_b \geq$ [N/mm <sup>2</sup> ]		6, 9 or 12	
Code		EN 771-1	
Producer (country code)		e.g. Imerys (FR)	
Brick dimensions [mm]		560 x 200 x 274	
Drilling method		Rotary	



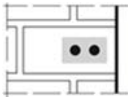
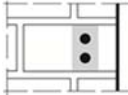
**Table C73: Spacing and edge distances**

Anchor size			All sizes
Edge distance	$C_{cr}$	[mm]	100 (120) <sup>1)</sup>
Minimum edge distance	$C_{min}^{2)}$	[mm]	100 (120) <sup>1)</sup>
Spacing	$S_{cr,II}$	[mm]	560
	$S_{cr,\perp}$	[mm]	274
Minimum spacing	$S_{min}$	[mm]	100

1) Value in brackets for VM-SH 20x85 and VM-SH 20x130

2) For  $V_{Rk,c}$ :  $c_{min}$  according to ETAG 029, Annex C

**Table C74: Group factor for anchor group in case of tension loading**

Configuration		with $c$ [mm] $\geq$	with $s$ [mm] $\geq$			
II: anchors placed parallel to horizontal joint		185	100	$\alpha_{g,N,II}$	[-]	1,9
		$C_{cr}$	560			2,0
⊥: anchors placed perpendicular to horizontal joint		185	100	$\alpha_{g,N,\perp}$	[-]	1,1
		$C_{cr}$	274			2,0

**Injection System VMU plus for masonry**

**Performance - Clay hollow brick Urbanbric**

Description of the brick, Spacing and edge distances, Group factor

**Annex C30**



Brick type: Clay hollow brick Urbanbric

**Table C75: Group factor for anchor group in case of shear loading parallel to free edge**

Configuration		with c [mm] ≥	with s [mm] ≥			
: anchors placed parallel to horizontal joint		$c_{cr}$	560	$\alpha_{g,V,  }$	[-]	2,0
⊥: anchors placed perpendicular to horizontal joint		$c_{cr}$	274	$\alpha_{g,V,\perp}$		2,0

**Table C76: Group factor for anchor groups in case of shear load perpendicular to free edge**

Configuration		with c [mm] ≥	with s [mm] ≥			
: anchors placed parallel to horizontal joint		$c_{cr}$	560	$\alpha_{g,V,  }$	[-]	2,0
⊥: anchors placed perpendicular to horizontal joint		$c_{cr}$	274	$\alpha_{g,V,\perp}$		2,0

**Table C77: Characteristic values of resistance under tension and shear load**

Anchor size	Sleeve	Effective Anchorage depth	Characteristic resistance			
			Use category			
			d/d w/d w/w			d/d w/d w/w
			40°C/24°C	80°C/50°C	120°C/72°C	All temperature ranges
$h_{ef}$	$N_{Rk,b} = N_{Rk,p}^{1)}$			$V_{Rk,b}^{2)3)}$		
[mm]	[kN]			[kN]		
<b>Compressive strength <math>f_b \geq 6 \text{ N/mm}^2</math></b>						
M8	12x80	80	0,9	0,9	0,75	3,0
M8 / M10/ IG-M6	16x85	85	0,9	0,9	0,75	3,0
	16x130	130	2,0	2,0	1,5	3,0
M12 / M16 / IG-M8 / IG-M10	20x85	85	0,9	0,9	0,75	3,5
	20x130	130	2,0	2,0	1,5	3,5
<b>Compressive strength <math>f_b \geq 9 \text{ N/mm}^2</math></b>						
M8	12x80	80	0,9	0,9	0,9	4,0
M8 / M10/ IG-M6	16x85	85	0,9	0,9	0,9	4,0
	16x130	130	2,5	2,5	2,0	4,0
M12 / M16 / IG-M8 / IG-M10	20x85	85	0,9	0,9	0,9	4,5
	20x130	130	2,5	2,5	2,0	4,5

1) Values are valid for  $c_{cr}$  and  $c_{min}$

2) Calculation of  $V_{Rk,c}$  see ETAG 029, Annex C, except for shear load parallel to free edge with  $c \geq 190 \text{ mm}$ :  $V_{Rk,c,||} = V_{Rk,b}$

3) The values are valid for steel 5.6 or higher. For steel 4.6 and 4.8 multiply  $V_{Rk,b}$  by 0,8

Injection System VMU plus for masonry

Performance - Clay hollow brick Urbanbric  
Group factor, Characteristic values of resistance

Annex C31

Brick type: Clay hollow brick Urbanbric

**Table C78: Characteristic values of resistance under tension and shear load (continue)**

Anchor size	Sleeve	Effective Anchorage depth	Characteristic resistance			
			Use category			
			d/d w/d w/w			d/d w/d w/w
			40°C/24°C	80°C/50°C	120°C/72°C	All temperature ranges
$h_{ef}$ [mm]	$N_{Rk,b} = N_{Rk,p}^{1)}$ [kN]			$V_{Rk,b}^{2)3)}$ [kN]		
<b>Compressive strength <math>f_b \geq 12 \text{ N/mm}^2</math></b>						
M8	12x80	80	1,2	1,2	0,9	4,5
M8 / M10/ IG-M6	16x85	85	1,2	1,2	0,9	4,5
	16x130	130	3,0	3,0	2,5	4,5
M12 / M16 / IG-M8 / IG-M10	20x85	85	1,2	1,2	0,9	5,0
	20x130	130	3,0	3,0	2,5	5,0

1) Values are valid for  $c_{cr}$  and  $c_{min}$

2) Calculation of  $V_{Rk,c}$  see ETAG 029, Annex C, except for shear load parallel to free edge with  $c \geq 190 \text{ mm}$ :  $V_{Rk,c,II} = V_{Rk,b}$

3) The values are valid for steel 5.6 or higher. For steel 4.6 and 4.8 multiply  $V_{Rk,b}$  by 0,8

**Table C79: Displacements**

Anchor size	Sleeve	$h_{ef}$	N	$\delta_N / N$	$\delta_{N0}$	$\delta_{N\infty}$	V	$\delta_{V0}$	$\delta_{V\infty}$
		[mm]	[kN]	[mm/kN]	[mm]	[mm]	[kN]	[mm]	[mm]
M8	12x80	80	0,34	0,80	0,27	0,55	1,30	1,00	1,50
M8 / M10/ IG-M6	16x85	85							
	16x130	130	0,69		1,37				
M12 / M16 / IG-M8 / IG-M10	20x85	85	0,27		0,55	1,43			
	20x130	130	0,69	1,37					


Injection System VMU plus for masonry

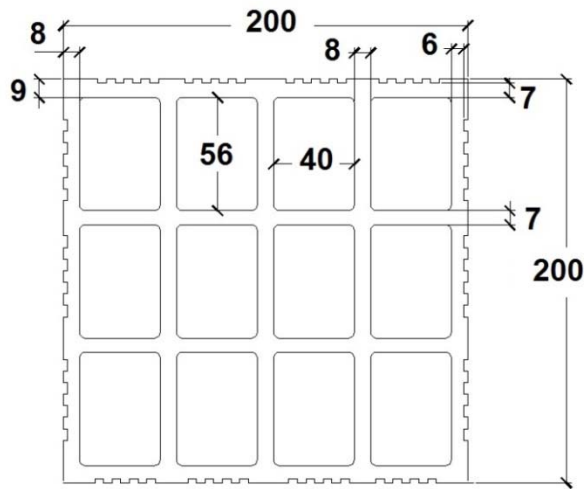
Performance - Clay hollow brick Urbanbric  
Characteristic values of resistance, Displacements

**Annex C32**

**Brick type: Clay hollow brick Brique creuse C40**

**Table C80: Description of the brick**

<b>Brick type</b>	Clay hollow brick Brique creuse C40		
Bulk density $\rho$ [kg/dm <sup>3</sup> ]	0,7		
Compressive strength $f_b \geq$ [N/mm <sup>2</sup> ]	4, 8 or 12		
Code	EN 771-1		
Producer (country code)	e.g. Terreal (FR)		
Brick dimensions [mm]	500 x 200 x 200		
Drilling method	Rotary		



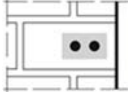
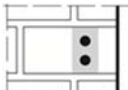
**Table C81: Spacing and edge distances**

Anchor size		All sizes	
Edge distance	$C_{cr}$ [mm]	100 (120) <sup>1)</sup>	
Minimum edge distance	$C_{min}^{2)}$ [mm]	100 (120) <sup>1)</sup>	
Spacing	$S_{cr,II}$ [mm]	500	
	$S_{cr,\perp}$ [mm]	200	
Minimum spacing	$S_{min}$ [mm]	200	

<sup>1)</sup> Values in brackets for VM-SH 20x85 and VM-SH 20x130

<sup>2)</sup> For  $V_{Rk,c}$ :  $C_{min}$  according to ETAG 029, Annex C

**Table C82: Group factor for anchor group in case of tension loading**

Configuration		with $c$ [mm] $\geq$	with $s$ [mm] $\geq$			
II: anchors placed parallel to horizontal joint		$C_{cr}$	200	$\alpha_{g,N,II}$	[-]	2,0
$\perp$ : anchors placed perpendicular to horizontal joint		$C_{cr}$	200	$\alpha_{g,N,\perp}$		2,0

**Injection System VMU plus for masonry**

**Performance - Clay hollow brick Brique creuse C40**

Description of the brick, Spacing and edge distances, Group factor

**Annex C33**

**Brick type: Clay hollow brick Brique creuse C40**

**Table C83: Group factor for anchor group in case of shear loading parallel to free edge**

Configuration		with c [mm] ≥	with s [mm] ≥			
II: anchors placed parallel to horizontal joint		$C_{cr}$	500	$\alpha_{g,V,II}$	[-]	2,0
I: anchors placed perpendicular to horizontal joint		$C_{cr}$	200	$\alpha_{g,V,I}$		2,0

**Table C84: Group factor for anchor group in case of shear load perpendicular to free edge**

Configuration		with c [mm] ≥	with s [mm] ≥			
II: anchors placed parallel to horizontal joint		$C_{cr}$	500	$\alpha_{g,V,II}$	[-]	2,0
I: anchors placed perpendicular to horizontal joint		$C_{cr}$	200	$\alpha_{g,V,I}$		2,0

**Table C85: Characteristic values of resistance under tension and shear load**

Anchor size	Sleeve	Effective Anchorage depth	Characteristic resistance			
			Use category			
			d/d w/d w/w			d/d w/d w/w
			40°C/24°C	80°C/50°C	120°C/72°C	All temperature ranges
$h_{ef}$	$N_{Rk,b} = N_{Rk,p}^{1)}$			$V_{Rk,b}^{2)3)}$		
[mm]	[kN]			[kN]		
<b>Compressive strength <math>f_b \geq 4 \text{ N/mm}^2</math></b>						
M8	12x80	80	0,6	0,6	0,6	0,9
M8 / M10/ IG-M6	16x85	85				
	16x130	130				
M12 / M16 / IG-M8 / IG-M10	20x85	85				
	20x130	130				
<b>Compressive strength <math>f_b \geq 8 \text{ N/mm}^2</math></b>						
M8	12x80	80	0,9	0,9	0,75	1,2
M8 / M10/ IG-M6	16x85	85				
	16x130	130				
M12 / M16 / IG-M8 / IG-M10	20x85	85				
	20x130	130				

1) Values are valid for  $c_{cr}$  and  $c_{min}$

2) Calculation of  $V_{Rk,c}$  see ETAG 029, Annex C

3) The values are valid for steel 5.6 or higher. For steel 4.6 and 4.8 multiply  $V_{Rk,b}$  by 0,8

**Injection System VMU plus for masonry**

**Annex C34**

**Performance - Clay hollow brick Brique creuse C40**

Group factor, Characteristic values of resistance

**Brick type: Clay hollow brick Brique creuse C40**

**Table C86: Characteristic values of resistance under tension and shear load (continue)**

Anchor size	Sleeve	Effective Anchorage depth	Characteristic resistance			
			Use category			
			d/d w/d w/w			d/d w/d w/w
			40°C/24°C	80°C/50°C	120°C/72°C	All temperature ranges
$h_{ef}$	$N_{Rk,b} = N_{Rk,p}^{1)}$			$V_{Rk,b}^{2)3)}$		
[mm]	[kN]			[kN]		
<b>Compressive strength <math>f_b \geq 12 \text{ N/mm}^2</math></b>						
M8	12x80	80	1,2	1,2	0,9	1,5
M8 / M10/ IG-M6	16x85	85				
	16x130	130				
M12 / M16 / IG-M8 / IG-M10	20x85	85				
	20x130	130				

1) Values are valid for  $c_{cr}$  and  $c_{min}$

2) Calculation of  $V_{Rk,c}$  see ETAG 029, Annex C

3) The values are valid for steel 5.6 or higher. For steel 4.6 and 4.8 multiply  $V_{Rk,b}$  by 0,8

**Table C87: Displacements**

Anchor size	Sleeve	$h_{ef}$	N	$\delta_N / N$	$\delta_{N0}$	$\delta_{N\infty}$	V	$\delta_{v0}$	$\delta_{v\infty}$
		[mm]	[kN]	[mm/kN]	[mm]	[mm]	[kN]	[mm]	[mm]
M8	12x80	80	0,17	0,80	0,14	0,27	0,3	0,9	1,35
M8 / M10/ IG-M6	16x85	85							
	16x130	130	0,14		0,11	0,23			
M12 / M16 / IG-M8 / IG-M10	20x85	85	0,17		0,14	0,27			
	20x130	130	0,14	0,11	0,23				


**Injection System VMU plus for masonry**

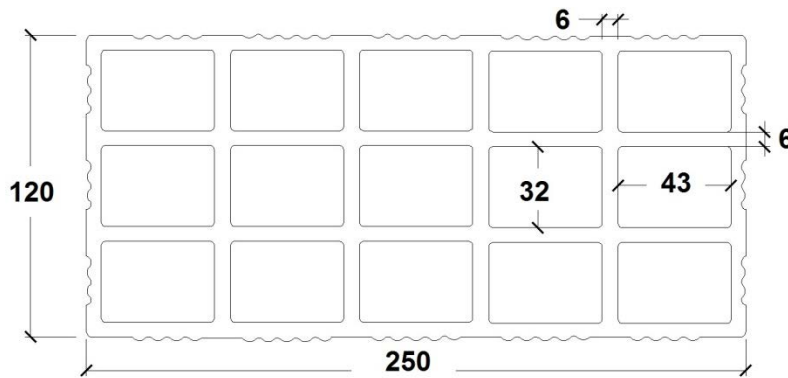
**Performance - Clay hollow brick Brique creuse C40**  
Characteristic values of resistance, Displacements

**Annex C35**

**Brick type: Clay hollow brick Blocchi Leggeri**

**Table C88: Description of the brick**

<b>Brick type</b>	Clay hollow brick Blocchi Leggeri		
Bulk density $\rho$ [kg/dm <sup>3</sup> ]		0,6	
Compressive strength $f_b \geq$ [N/mm <sup>2</sup> ]		4, 6, 8 or 12	
Code		EN 771-1	
Producer (country code)		e.g. Wienerberger (IT)	
Brick dimensions [mm]		250 x 120 x 250	
Drilling method		Rotary	

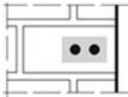
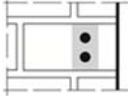


**Table C89: Spacing and edge distances**

Anchor size			All sizes
Edge distance	$C_{cr}$	[mm]	100 (120) <sup>1)</sup>
Minimum edge distance	$C_{min}$	[mm]	60
Spacing	$S_{cr,  }$	[mm]	250
	$S_{cr,\perp}$	[mm]	120
Minimum spacing	$S_{min}$	[mm]	100

<sup>1)</sup> Value in brackets for VM-SH 20x85; VM-SH 20x130 and VM-SH 20x200

**Table C90: Group factor for anchor group in case of tension loading**

Configuration		with $c$ [mm] $\geq$	with $s$ [mm] $\geq$			
: anchors placed parallel to horizontal joint		60	100	$\alpha_{g,N,  }$	[-]	1,0
		$C_{cr}$	250			2,0
⊥: anchors placed perpendicular to horizontal joint		60	100	$\alpha_{g,N,\perp}$		2,0

**Injection System VMU plus for masonry**

**Performance - Clay hollow brick Blocchi Leggeri**  
Description of the brick, Spacing and edge distances, Group factor

**Annex C36**

**Brick type: Clay hollow brick Blocchi Leggeri**

**Table C91: Group factor for anchor group in case of shear loading parallel to free edge**

Configuration		with c [mm] ≥	with s [mm] ≥			
II: anchors placed parallel to horizontal joint		60 <sup>1)</sup>	100 <sup>1)</sup>	$\alpha_{g,V,II}$	[-]	1,0
		$c_{cr}$	250			2,0
⊥: anchors placed perpendicular to horizontal joint		60 <sup>1)</sup>	100 <sup>1)</sup>	$\alpha_{g,V,\perp}$	[-]	1,6
		$c_{cr}$	250			2,0

<sup>1)</sup> Only valid for  $V_{Rk,b}$  according to Table C93 and C94 values in brackets

**Table C92: Group factor for anchor group in case of shear load perpendicular to free edge**

Configuration		with c [mm] ≥	with s [mm] ≥			
II: anchors placed parallel to horizontal joint		60 <sup>1)</sup>	100 <sup>1)</sup>	$\alpha_{g,V,II}$	[-]	1,0
		$c_{cr}$	250			2,0
⊥: anchors placed perpendicular to horizontal joint		60 <sup>1)</sup>	100 <sup>1)</sup>	$\alpha_{g,V,\perp}$	[-]	1,6
		$c_{cr}$	250			2,0

<sup>1)</sup> Only valid for  $V_{Rk,b}$  according to Table C93 and C94 values in brackets

**Table C93: Characteristic values of resistance under tension and shear load**

Anchor size	Sleeve	Effective Anchorage depth	Characteristic resistance			
			Use category			
			d/d w/d w/w			d/d w/d w/w
			40°C/24°C	80°C/50°C	120°C/72°C	All temperature ranges
		$h_{ef}$	$N_{Rk,b} = N_{Rk,p}^{1)}$			$V_{Rk,b}^{4)}$
		[mm]	[kN]			[kN]
<b>Compressive strength <math>f_b \geq 4 \text{ N/mm}^2</math></b>						
M8	12x80	80	0,4	0,4	0,3	2,0 <sup>2)</sup> (0,9) <sup>3)</sup>
M8 / M10/ IG-M6	16x85	85				
	16x130	130				
M12 / M16 / IG-M8 / IG-M10	20x85	85				
	20x130	130				
	20x200	200				

<sup>1)</sup> Values are valid for  $c_{cr}$  and  $c_{min}$

<sup>2)</sup> Calculation of  $V_{Rk,c}$  see ETAG 029, Annex C, except for shear load parallel to free edge with  $c \geq 125 \text{ mm}$ :  $V_{Rk,c,II} = V_{Rk,b}$

<sup>3)</sup> Values in brackets  $V_{Rk,c} = V_{Rk,b}$  for anchors with  $c_{min}$

<sup>4)</sup> The values are valid for steel 5.6 or higher. For steel 4.6 and 4.8 multiply  $V_{Rk,b}$  by 0,8

**Injection System VMU plus for masonry**

**Performance - Clay hollow brick Blocchi Leggeri**  
Group factor, Characteristic values of resistance

**Annex C37**

Brick type: Clay hollow brick Blocchi Leggeri

**Table C94: Characteristic values of resistance under tension and shear load (continue)**

Anchor size	Sleeve	Effective Anchorage depth	Characteristic resistance			
			Use category			
			d/d w/d w/w			d/d w/d w/w
			40°C/24°C	80°C/50°C	120°C/72°C	All temperature ranges
$h_{ef}$	$N_{Rk,b} = N_{Rk,p}^{1)}$			$V_{Rk,b}^{4)}$		
[mm]	[kN]			[kN]		
<b>Compressive strength <math>f_b \geq 6 \text{ N/mm}^2</math></b>						
M8	12x80	80	0,5	0,5	0,4	2,5 <sup>2)</sup> (1,2) <sup>3)</sup>
M8 / M10 / IG-M6	16x85	85				
	16x130	130				
M12 / M16 / IG-M8 / IG-M10	20x85	85				
	20x130	130				
	20x200	200				
<b>Compressive strength <math>f_b \geq 8 \text{ N/mm}^2</math></b>						
M8	12x80	80	0,6	0,6	0,5	3,0 <sup>2)</sup> (1,2) <sup>3)</sup>
M8 / M10 / IG-M6	16x85	85				
	16x130	130				
M12 / M16 / IG-M8 / IG-M10	20x85	85				
	20x130	130				
	20x200	200				
<b>Compressive strength <math>f_b \geq 12 \text{ N/mm}^2</math></b>						
M8	12x80	80	0,6	0,6	0,6	3,5 <sup>2)</sup> (1,5) <sup>3)</sup>
M8 / M10 / IG-M6	16x85	85				
	16x130	130				
M12 / M16 / IG-M8 / IG-M10	20x85	85				
	20x130	130				
	20x200	200				

- 1) Values are valid for  $C_{cr}$  and  $C_{min}$
- 2) Calculation of  $V_{Rk,c}$  see ETAG 029, Annex C, except for shear load parallel to free edge with  $c \geq 125 \text{ mm}$ :  $V_{Rk,c,II} = V_{Rk,b}$
- 3) Values in brackets  $V_{Rk,c} = V_{Rk,b}$  for anchors with  $C_{min}$
- 4) The values are valid for steel 5.6 or higher. For steel 4.6 and 4.8 multiply  $V_{Rk,b}$  by 0,8

**Table C95: Displacements**

Anchor size	Sleeve	$h_{ef}$	N	$\delta_N / N$	$\delta_{N0}$	$\delta_{N\infty}$	V	$\delta_{v0}$	$\delta_{v\infty}$
		[mm]	[kN]	[mm/kN]	[mm]	[mm]	[kN]	[mm]	[mm]
All sizes	All sizes	All sizes	0,17	1,20	0,21	0,41	0,9	1,20	1,80

Injection System VMU plus for masonry

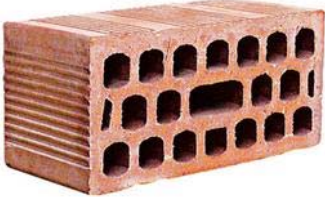
Performance - Clay hollow brick Blocchi Leggeri  
Characteristic values of resistance, Displacements

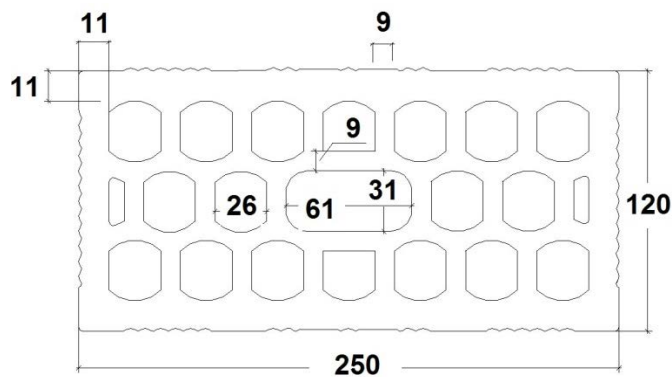
**Annex C38**



**Brick type: Clay hollow brick Doppio Uni**

**Table C96: Description of the brick**

<b>Brick type</b>	Clay hollow brick Doppio Uni		
Bulk density $\rho$ [kg/dm <sup>3</sup> ]		0,9	
Compressive strength $f_b \geq$ [N/mm <sup>2</sup> ]		10, 16, 20 or 28	
Code		EN 771-1	
Producer (country code)		e.g. Wienerberger (IT)	
Brick dimensions [mm]		250 x 120 x 120	
Drilling method		Rotary	

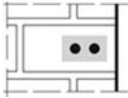
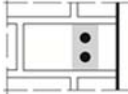


**Table C97: Spacing and edge distances**

Anchor size		All sizes	
Edge distance	$C_{cr}$ [mm]	100 (120) <sup>1)</sup>	
Minimum edge distance	$C_{min}$ <sup>2)</sup> [mm]	60	
Spacing	$S_{cr,II}$ [mm]	250	
	$S_{cr,\perp}$ [mm]	120	
Minimum spacing	$S_{min,II}$ [mm]	100	
	$S_{min,\perp}$ [mm]	120	

- 1) Value in brackets for VM-SH 20x85; VM-SH 20x130 and VM-SH 20x200  
 2) For  $V_{Rk,c}$ :  $C_{min}$  according to ETAG 029, Annex C

**Table C98: Group factor for anchor group in case of tension loading**

Configuration		with $c$ [mm] $\geq$	with $s$ [mm] $\geq$			
II: anchors placed parallel to horizontal joint		60	100	$\alpha_{g,N,II}$	[-]	1,0
		$C_{cr}$	250			2,0
I: anchors placed perpendicular to horizontal joint		60	100	$\alpha_{g,N,\perp}$		2,0

**Injection System VMU plus for masonry**

**Performance - Clay hollow brick Doppio Uni**  
 Description of the brick, Spacing and edge distances, Group factor

**Annex C39**

**Brick type: Clay hollow brick Doppio Uni**

**Table C99: Group factor for anchor group in case of shear loading parallel to free edge**

Configuration		with c [mm] ≥	with s [mm] ≥			
: anchors placed parallel to horizontal joint		$C_{cr}$	250	$\alpha_{g,V,  }$	[-]	2,0
⊥: anchors placed perpendicular to horizontal joint		$C_{cr}$	120	$\alpha_{g,V,\perp}$		2,0

**Table C100: Group factor for anchor group in case of shear load perpendicular to free edge**

Configuration		with c [mm] ≥	with s [mm] ≥			
: anchors placed parallel to horizontal joint		$C_{cr}$	250	$\alpha_{g,V,  }$	[-]	2,0
⊥: anchors placed perpendicular to horizontal joint		$C_{cr}$	120	$\alpha_{g,V,\perp}$		2,0

**Table C101: Characteristic values of resistance under tension and shear load**

Anchor size	Sleeve	Effective Anchorage depth	Characteristic resistance			
			Use category			
			d/d w/d w/w			d/d w/d w/w
			40°C/24°C	80°C/50°C	120°C/72°C	All temperature ranges
		$h_{ef}$	$N_{Rk,b} = N_{Rk,p}^{1)}$			$V_{Rk,b}^{2)3)}$
		[mm]	[kN]			[kN]
<b>Compressive strength <math>f_b \geq 10 \text{ N/mm}^2</math></b>						
M8	12x80	80	0,6	0,6	0,5	1,5
M8 / M10/ IG-M6	16x85	85				
	16x130	130				
M12 / M16 / IG-M8 / IG-M10	20x85	85				
	20x130	130				
	20x200	200				

1) Values are valid for  $C_{cr}$  and  $C_{min}$

2) Calculation of  $V_{Rk,c}$  see ETAG 029, Annex C

3) The values are valid for steel 5.6 or higher. For steel 4.6 and 4.8 multiply  $V_{Rk,b}$  by 0,8

**Injection System VMU plus for masonry**

**Annex C40**

**Performance - Clay hollow brick Doppio Uni**  
Group factor, Characteristic values of resistance

Brick type: Clay hollow brick Doppio Uni

**Table C102: Characteristic values of resistance under tension and shear load (continue)**

Anchor size	Sleeve	Effective Anchorage depth	Characteristic resistance			
			Use category			
			d/d w/d w/w			d/d w/d w/w
			40°C/24°C	80°C/50°C	120°C/72°C	All temperature ranges
$h_{ef}$	$N_{Rk,b} = N_{Rk,p}^{1)}$			$V_{Rk,b}^{2)3)}$		
[mm]	[kN]			[kN]		
<b>Compressive strength <math>f_b \geq 16 \text{ N/mm}^2</math></b>						
M8	12x80	80	0,75	0,75	0,6	2,0
M8 / M10/ IG-M6	16x85	85				
	16x130	130				
M12 / M16 / IG-M8 / IG-M10	20x85	85				
	20x130	130				
	20x200	200				
<b>Compressive strength <math>f_b \geq 20 \text{ N/mm}^2</math></b>						
M8	12x80	80	0,9	0,9	0,75	2,0
M8 / M10/ IG-M6	16x85	85				
	16x130	130				
M12 / M16 / IG-M8 / IG-M10	20x85	85				
	20x130	130				
	20x200	200				
<b>Compressive strength <math>f_b \geq 28 \text{ N/mm}^2</math></b>						
M8	12x80	80	1,2	1,2	0,9	2,5
M8 / M10/ IG-M6	16x85	85				
	16x130	130				
M12 / M16 / IG-M8 / IG-M10	20x85	85				
	20x130	130				
	20x200	200				

1) Values are valid for  $c_{cr}$  and  $c_{min}$

2) Calculation of  $V_{Rk,c}$  see ETAG 029, Annex C

3) The values are valid for steel 5.6 or higher. For steel 4.6 and 4.8 multiply  $V_{Rk,b}$  by 0,8

**Table C103: Displacements**

Anchor size	Sleeve	$h_{ef}$	N	$\delta_N / N$	$\delta_{N0}$	$\delta_{N\infty}$	V	$\delta_{v0}$	$\delta_{v\infty}$
		[mm]	[kN]	[mm/kN]	[mm]	[mm]	[kN]	[mm]	[mm]
All sizes	All sizes	All sizes	0,26	1,20	0,31	0,62	0,6	0,3	0,45

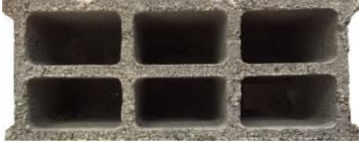
Injection System VMU plus for masonry

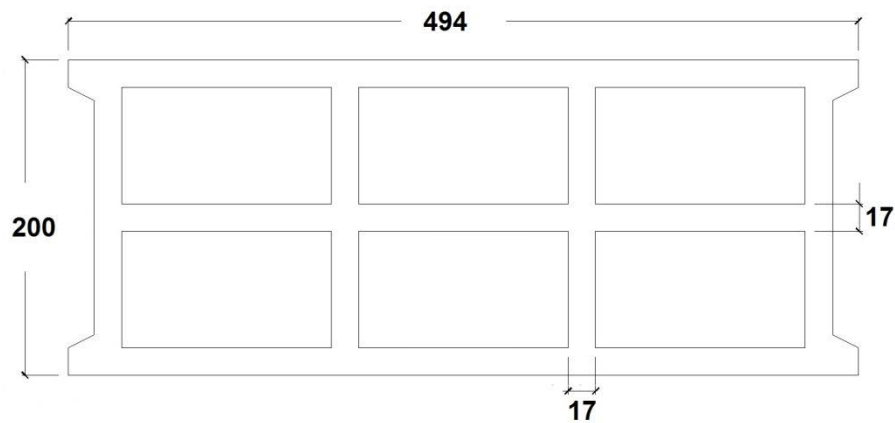
Performance - Clay hollow brick Doppio Uni  
Characteristic values of resistance, Displacements

**Annex C41**

**Brick type: Hollow lightweight concrete Bloc creux B40**

**Table C104: Description of the brick**

<b>Brick type</b>	Hollow Lightweight concrete Bloc creux B40		
Bulk density	$\rho$ [kg/dm <sup>3</sup> ]	0,8	
Compressive strength	$f_b \geq$ [N/mm <sup>2</sup> ]	4	
Code	EN 771-3		
Producer (country code)	e.g. Sepa (FR)		
Brick dimensions	[mm]	494 x 200 x 190	
Drilling method	Rotary		



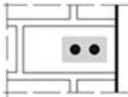
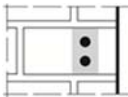
**Table C105: Spacing and edge distances**

Anchor size			All sizes
Edge distance	$C_{cr}$	[mm]	100 (120) <sup>1)</sup>
Minimum edge distance	$C_{min}$ <sup>2)</sup>	[mm]	100 (120) <sup>1)</sup>
Spacing	$S_{cr,  }$	[mm]	494
	$S_{cr,\perp}$	[mm]	190
Minimum spacing	$S_{min}$	[mm]	100

<sup>1)</sup> Value in brackets for VM-SH 20x85 and VM-SH 20x130

<sup>2)</sup> For  $V_{Rk,c}$ :  $C_{min}$  according to ETAG 029, Annex C

**Table C106: Group factor for anchor group in case of tension loading**

Configuration		with $c$ [mm] $\geq$	with $s$ [mm] $\geq$			
: anchors placed parallel to horizontal joint		100	100	$\alpha_{g,N,  }$	[-]	1,5
		$C_{cr}$	494			2,0
$\perp$ : anchors placed perpendicular to horizontal joint		100	100	$\alpha_{g,N,\perp}$	[-]	1,0
		$C_{cr}$	190			2,0

**Injection System VMU plus for masonry**

**Annex C42**

**Performance - Hollow Lightweight concrete Bloc creux B40**  
Description of the brick, Spacing and edge distances, Group factor

**Brick type: Hollow lightweight concrete Bloc creux B40**

**Table C107: Group factor for anchor group in case of shear loading parallel to free edge**

Configuration		with c [mm] ≥	with s [mm] ≥			
II: anchors placed parallel to horizontal joint		50	100	$\alpha_{g,V,II}$	[-]	1,1
		$c_{cr}$	494			2,0
⊥: anchors placed perpendicular to horizontal joint		100	100	$\alpha_{g,V,\perp}$	[-]	1,1
		$c_{cr}$	190			2,0

**Table C108: Group factor for anchor group in case of shear load perpendicular to free edge**

Configuration		with c [mm] ≥	with s [mm] ≥			
II: anchors placed parallel to horizontal joint		$c_{cr}$	494	$\alpha_{g,V,II}$	[-]	2,0
		$c_{cr}$	190			$\alpha_{g,V,\perp}$

**Table C109: Characteristic values of resistance under tension and shear load**

Anchor size	Sleeve	Effective anchorage depth	Characteristic resistance							
			Use category							
			d/d			w/d w/w			d/d w/d w/w	
			40°C/24°C	80°C/50°C	120°C/72°C	40°C/24°C	80°C/50°C	120°C/72°C	All temperature ranges	
		$h_{ef}$	$N_{Rk,b} = N_{Rk,p}^{1)}$			$N_{Rk,b} = N_{Rk,p}^{1)}$			$V_{Rk,b}^{2)3)}$	
		[mm]	[kN]							
Compressive strength $f_b \geq 4 \text{ N/mm}^2$										
M8	12x80	80	1,2	0,9	0,75	0,9	0,75	3,0		
M8 / M10/ IG-M6	16x85	85								0,9
	16x130	130								1,2
M12 / M16 / IG-M8 / IG-M10	20x85	85								1,2
	20x130	130	1,2							

1) Values are valid for  $c_{cr}$  and  $c_{min}$

2) Calculation of  $V_{Rk,c}$  see ETAG 029, Annex C, except for shear load parallel to free edge with  $c \geq 250 \text{ mm}$ :  $V_{Rk,c,II} = V_{Rk,b}$

3) The values are valid for steel 5.6 or higher. For steel 4.6 and 4.8 multiply  $V_{Rk,b}$  by 0,8

**Table C110: Displacements**

Anchor size	Sleeve	$h_{ef}$	N	$\delta_N / N$	$\delta_{N0}$	$\delta_{N\infty}$	V	$\delta_{V0}$	$\delta_{V\infty}$
		[mm]	[kN]	[mm/kN]	[mm]	[mm]	[kN]	[mm]	[mm]
All sizes	All sizes	All sizes	0,34	0,90	0,31	0,62	0,86	0,9	1,35


**Injection System VMU plus for masonry**

**Performance - Hollow lightweight concrete Bloc creux B40**  
Group factor, Characteristic values of resistance, Displacements

**Annex C43**

**Brick type: Solid lightweight concrete - LAC**

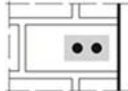
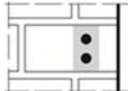
**Table C111: Description of the brick**

<b>Brick type</b>	Solid lightweight concrete LAC		
Bulk density	$\rho$ [kg/dm <sup>3</sup> ]	0,6	
Compressive strength	$f_b \geq$ [N/mm <sup>2</sup> ]	2	
Code	EN 771-3		
Producer (country code)	e.g. Bisotherm (DE)		
Brick dimensions	[mm]	300 x 123 x 248	
Drilling method	Rotary		

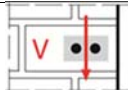

**Table C112: Spacing and edge distances**

Anchor size			All sizes
Edge distance	$c_{cr}$	[mm]	$1,5 \cdot h_{ef}$
Minimum edge distance	$c_{min}$	[mm]	60
Spacing	$s_{cr}$	[mm]	$3 \cdot h_{ef}$
Minimum spacing	$s_{min}$	[mm]	120

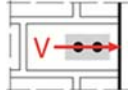
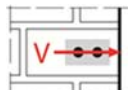
**Table C113: Group factor for anchor group in case of tension loading**

Configuration		with $c$ [mm] $\geq$	with $s$ [mm] $\geq$	$\alpha_{g,N,II}$	[-]	
II: anchors placed parallel to horizontal joint		90	120			
		$1,5 \cdot h_{ef}$	$3 \cdot h_{ef}$	2,0		
⊥: anchors placed perpendicular to horizontal joint		124	120	$\alpha_{g,N,\perp}$		1,1
		$1,5 \cdot h_{ef}$	$3 \cdot h_{ef}$			2,0

**Table C114: Group factor for anchor group in case of shear loading parallel to free edge**

Configuration		with $c$ [mm] $\geq$	with $s$ [mm] $\geq$	$\alpha_{g,V,II}$	[-]	
II: anchors placed parallel to horizontal joint		60	120			
		90	120	2,0		
⊥: anchors placed perpendicular to horizontal joint		60	120	$\alpha_{g,V,\perp}$		0,6
		124	120			2,0

**Table C115: Group factor for anchor group in case of shear load perpendicular to free edge**

Configuration		with $c$ [mm] $\geq$	with $s$ [mm] $\geq$	$\alpha_{g,V,II}$	[-]	
II: anchors placed parallel to horizontal joint		60	120			
		90	120	2,0		
⊥: anchors placed perpendicular to horizontal joint		60	120	$\alpha_{g,V,\perp}$		0,6
		$1,5 \cdot h_{ef}$	120			1,0
		$1,5 \cdot h_{ef}$	$3 \cdot h_{ef}$			2,0

**Injection System VMU plus for masonry**

**Annex C44**

**Performance - Solid lightweight concrete - LAC**

Description of the brick, Spacing and edge distances, Group factor

Brick type: Solid lightweight concrete - LAC

**Table C116: Characteristic values of resistance under tension and shear load**

Anchor size	Sleeve	Effective anchorage depth	Characteristic resistance						
			Use category						
			d/d			w/d w/w			d/d w/d w/w
			40°C/24°C	80°C/50°C	120°C/72°C	40°C/24°C	80°C/50°C	120°C/72°C	All temperature ranges
$h_{ef}$ [mm]	$N_{Rk,b} = N_{Rk,p}^{1)}$			$N_{Rk,b} = N_{Rk,p}^{1)}$			$V_{Rk,b}^{2)3)}$		
[kN]									
<b>Compressive strength <math>f_b \geq 2 \text{ N/mm}^2</math></b>									
M8	-	80	3,0	2,5	2,0	2,5	2,0	1,5	3,0
M8 / M10/ IG-M6	-	90	3,0	3,0	2,0	2,5	2,5	2,0	3,0
M10 / IG-M8	-	100	3,5	3,0	2,5	3,0	2,5	2,0	3,0
M16 / IG-M10	-	100	3,0	3,0	2,0	3,0	3,0	2,0	3,0
M8	12x80	80	2,5	2,5	2,0	2,5	2,0	1,5	3,0
M8 / M10/ IG-M6	16x85	85	3,0	2,5	2,0	3,0	2,5	2,0	3,0
	16x130	130	3,0	2,5	2,0	3,0	2,5	2,0	3,0
M12 / M16 / IG-M8 / IG-M10	20x85	85	2,5	2,5	2,0	2,5	2,5	2,0	3,0
	20x130	130							
	20x200	200							

- 1) Values are valid for  $c_{Cr}$ , values in brackets are valid for single anchors with  $c_{min}$
- 2) For calculation of  $V_{Rk,c}$  see ETAG029, Annex C
- 3) The values are valid for steel 5.6 or higher. For steel 4.6 and 4.8 multiply  $V_{Rk,b}$  by 0,8

**Table C117: Displacements**

Anchor size	Sleeve	$h_{ef}$	N	$\delta_N / N$	$\delta_{N0}$	$\delta_{N\infty}$	V	$\delta_{V0}$	$\delta_{V\infty}$
		[mm]	[kN]	[mm/kN]	[mm]	[mm]	[kN]	[mm]	[mm]
M8	-	80	0,86	0,50	0,43	0,86	0,9	0,25	0,38
M8 / M10/ IG-M6	-	90							
M10 / IG-M8	-	100							
M16 / IG-M10	-	100	0,86	0,35	0,35	0,70			
M8	12x80	80	0,71	0,35	0,25	0,50	0,9	0,25	0,38
M8 / M10/ IG-M6	16x85	85							
	16x130	130							
M12 / M16 / IG-M8 / IG-M10	20x85	85							
	20x130	130							
	20x200	200							

Injection System VMU plus for masonry

**Performance - Solid lightweight concrete - LAC**  
Characteristic values of resistance, Displacements

**Annex C45**