



...eine starke Verbindung

YDEEVNEDEKLARATION

DoP Nr.: **MKT-2.1-101_da**

- ❖ **Varetypens unikke identifikationskode:** **Injektionssystem VMZ**
- ❖ **Tilsligtet anvendelse:** Kraftstyret ekspanderende anker med ankerstang VMZ-A og indvendigt gevindskåret mufte VMZ-IG til forankring i beton, se bilag / Annex B,
- ❖ **Fabrikant:** MKT Metall-Kunststoff-Technik GmbH & Co.KG
Auf dem Immel 2
67685 Weilerbach
- ❖ **System eller systemer til vurdering og kontrol af konstansen af ydeevnen:** 1
- ❖ **Europæisk vurderingsdokument:** **EAD 330499-01-0601**
Europæisk teknisk vurdering: **ETA-04/0092, 04.08.2021**
Teknisk vurderingsorgan: DIBt, Berlin
Notificeret organ/notificerede organer: NB 2873 – Technische Universität Darmstadt
- ❖ **Deklareret ydeevne/deklarerede ydeevner:**

Væsentlige funktioner	Ydeevne
Mekanisk modstandsdygtighed og stabilitet (BWR 1)	
Karakteristiske modstande under trækbelastning (statiske og kvasistatiske effekter)	Bilag / Annex B5 – B6, C1 – C3, C10
Karakteristiske modstande under tværgående stress (statiske og kvasistatiske effekter)	Bilag / Annex C4 – C5, C11
Forskydninger	Bilag / Annex C8 – C9, C11
Karakteristisk modstand og forskydninger for seismisk ydeevne kategori C1 + C2	Bilag / Annex C6 – C9
Hygiejne, sundhed og miljø (BWR 3)	
Indhold, emission og / eller frigivelse af farlige stoffer	Ydeevne ikke bedømt

Ydeevnen for den vare, der er anført ovenfor, er i overensstemmelse med den deklarerede ydeevne. Denne ydeevnedeklaration er udarbejdet i overensstemmelse med forordning (EU) nr. 305/2011 på eneansvar af den fabrikant, der er anført ovenfor.

Underskrevet for fabrikanten og på dennes vegne af:

Stefan Weustenhagen
(CEO)
Weilerbach, 04.08.2021

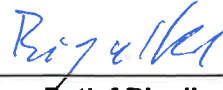
p.p. 
Dipl.-Ing. Detlef Bigalke
(Leder af produktudvikling)



Originalen af denne erklæringserklæring blev skrevet på tysk. I tilfælde af afvigelser i oversættelsen er den tyske udgave gyldig.

Specifications of intended use

Injection System VMZ with anchor rod		VMZ-A	M8	M10	M12	M16	M20	M24
Static and quasi-static action					✓			
Seismic action (Category C1 + C2)			-	✓	✓	✓	✓	✓
Cracked or uncracked concrete					✓			
Strength classes acc. to EN 206-1:2013+A1:2016					C20/25 to C50/60			
Reinforced or unreinforced normal weight concrete acc. to EN 206-1: 2013+A1:2016					✓			
Temperature Range I	-40 °C to +80 °C		max. short term temperature +80 °C max. long term temperature +50 °C					
Temperature Range II	-40 °C to +120 °C		max. short term temperature +120 °C max. long term temperature +72 °C					
Making of drill hole	Hammer drill bit				✓			
	Vacuum drill bit ¹⁾	-	✓	✓	✓	✓	✓	✓
	Diamond drill bit (seismic action excluded)	-	✓	✓	✓	✓	✓	✓
Installation allowable in	dry concrete				✓			
	wet concrete				✓			
	water-filled hole	-	-	✓ ²⁾	✓	✓	✓	✓
Overhead installation					✓			
Pre-setting installation					✓			
Trough-setting installation			-	✓	✓	✓	✓	✓

¹⁾ e.g. MKT vacuum drill bit, Würth hammer drill bit with suction or Heller Duster Expert

²⁾ Exception: VMZ-A 75 M12 (Installation in water-filled drill hole is not allowed)

Injection System VMZ with anchor rod		VMZ-IG	M6	M8	M10	M12	M16	M20
Static and quasi-static action					✓			
Seismic action (Category C1 + C2)					-			
Cracked and uncracked concrete					✓			
Strength classes acc. to EN 206-1:2013+A1:2016					C20/25 to C50/60			
Reinforced or unreinforced normal weight concrete acc. to EN 206-1:2013+A1:2016					✓			
Temperature Range I	-40 °C to +80 °C		max. short term temperature +80 °C max. long term temperature +50 °C					
Temperature Range II	-40 °C to +120 °C		max. short term temperature +120 °C max. long term temperature +72 °C					
Making of drill hole	Hammer drill bit				✓			
	Vacuum drill bit ¹⁾	-	✓	✓	✓	✓	✓	✓
	Diamond drill bit	-	✓	✓	✓	✓	✓	✓
Installation allowable in	dry concrete				✓			
	wet concrete				✓			
	water-filled hole	-	-	✓	✓	✓	✓	✓
Overhead installation					✓			
Pre-setting installation					✓			

¹⁾ e.g. MKT vacuum drill bit, Würth hammer drill bit with suction or Heller Duster Expert

Injection System VMZ

Intended use
Specifications and installation conditions

Annex B1

Specifications of intended use

Use conditions (Environmental conditions):

- Structures subject to dry internal conditions: all versions VMZ-A and VMZ-IG
- For all other conditions:
Intended use of materials according to Annex A3, Table A1 and Annex A5, Table A4 corresponding to the corrosion resistance class CRC to EN 1993-1-4:2015

Design:

- Anchorages are designed under the responsibility of an engineer experienced in anchorages and concrete work.
- Verifiable calculation notes and drawings are prepared taking account of the loads to be anchored. The position of the anchor is indicated on the design drawings (e.g. position of the anchor relative to reinforcement or to supports, etc.).
- Anchorages are designed in accordance with EN 1992-4:2018 and Technical Report TR 055.

Installation:

- Drill hole must be cleaned directly prior to installation of the anchor or the drill hole has to be protected against re-contamination in an appropriate way until dispensing the mortar in the drill hole.
- Water filled drill holes must not be polluted – otherwise the cleaning of the drill hole must be repeated.
- The anchor component installation temperature shall be at least +5 °C; during curing of the injection mortar the temperature of the concrete must not fall below -15 °C.
- It must be ensured that icing does not occur in the drill hole.
- Optionally, the annular gap between anchor rod and fixture may be filled with injection adhesive VMZ using the washer with bore (Part 2b, Annex A3) instead of the washer (Part 2a, Annex A3).

Injection System VMZ

Intended use
Specifications

Annex B2

Table B1: Working and curing time VMZ

Temperature in the drill hole	Maximum working time	Minimum curing time dry concrete ¹⁾
- 15 °C to - 10 °C	45 min	7 d
- 9 °C to - 5 °C	45 min	10:30 h
- 4 °C to - 1 °C	45 min	6:00 h
0 °C to + 4 °C	20 min	3:00 h
+5 °C to + 9 °C	12 min	2:00 h
+10 °C to +19 °C	6 min	1:20 h
+20 °C to +29 °C	4 min	45 min
+30 °C to +34 °C	2 min	25 min
+35 °C to +39 °C	1,4 min	20 min
+ 40 °C	1,4 min	15 min
Cartridge temperature	≥ 5°C	

¹⁾ curing time in wet concrete shall be doubled

Table B2: Working and curing time VMZ express

Temperature in the drill hole	Maximum working time	Minimum curing time dry concrete ¹⁾
- 5 °C to - 1 °C	20 min	4:00 h
0 °C to + 4 °C	10 min	2:00 h
+ 5 °C to + 9 °C	6 min	1:00 h
+10 °C to +19 °C	3 min	40 min
+20 °C to +29 °C	1 min	20 min
+ 30 °C	1 min	10 min
Cartridge temperature	≥ 5°C	

¹⁾ Curing time in wet concrete shall be doubled

Injection System VMZ

Intended use
Working and curing time

Annex B3

Table B3: Installation parameters, VMZ-A M8 – M12

Anchor size	VMZ-A	40 M8	50 M8	60 M10	75 M10	75 M12	70 M12	80 M12	95 M12	100 M12	110 M12	125 M12
Effective anchorage depth	$h_{ef} \geq$ [mm]	40	50	60	75	75	70	80	95	100	110	125
Nominal diameter of drill hole	$d_0 =$ [mm]	10	10	12	12	12	14	14	14	14	14	14
Depth of drill hole	$h_0 \geq$ [mm]	42	55	65	80	80	75	85	100	105	115	130
Diameter of cleaning brush	$D \geq$ [mm]	10,8	10,8	13,0	13,0	13,0	15,0	15,0	15,0	15,0	15,0	15,0
Installation torque	$T_{inst} \leq$ [Nm]	10	10	15	15	25	25	25	25	30	30	30
Diameter of clearance hole in the fixture												
Pre-setting installation	$d_f \leq$ [mm]	9	9	12	12	14	14	14	14	14	14	14
Through-setting installation	$d_f \leq$ [mm]	-	-	14	14	14 ¹⁾ / 16	16	16	16	16	16	16

¹⁾ see Annex B11

Table B4: Installation parameters, VMZ-A M16 – M24

Anchor size	VMZ-A	90 M16	105 M16	125 M16	145 M16	160 M16	115 M20	170 M20 (LG)	190 M20 (LG)	170 M24 (LG)	200 M24 (LG)	225 M24 (LG)
Effective anchorage depth	$h_{ef} \geq$ [mm]	90	105	125	145	160	115	170	190	170	200	225
Nominal diameter of drill hole	$d_0 =$ [mm]	18	18	18	18	18	22	24	24	26	26	26
Depth of drill hole	$h_0 \geq$ [mm]	98	113	133	153	168	120	180	200	185	215	240
Diameter of cleaning brush	$D \geq$ [mm]	19,0	19,0	19,0	19,0	19,0	23,0	25,0	25,0	27,0	27,0	27,0
Installation torque	$T_{inst} \leq$ [Nm]	50	50	50	50	50	80	80	80	100	120	120
Diameter of clearance hole in the fixture												
Pre-setting installation	$d_f \leq$ [mm]	18	18	18	18	18	22	24 (22)	24 (22)	26	26	26
Through-setting installation	$d_f \leq$ [mm]	20	20	20	20	20	24	26	26	28	28	28

Pre-setting installation

Through-setting installation

size
M8 to M16,
M20 LG, M24 LG

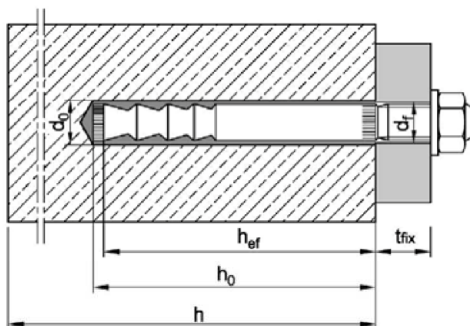

size
M20 + M24

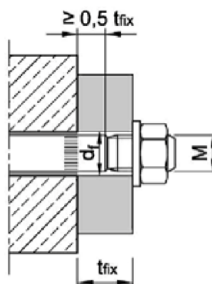

size
M10 to M16,
M20 LG, M24 LG

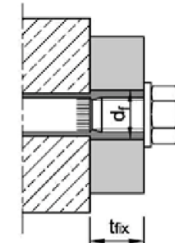

size
M20 + M24

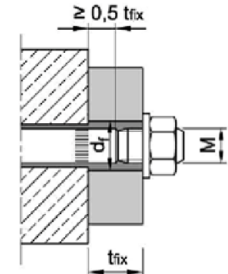

The annular gap in the clearance hole in the fixture has to be filled completely by excess mortar!

Injection System VMZ

Intended use
Installation parameters **VMZ-A**

Annex B4

Table B5: Minimum spacing and edge distance, VMZ-A M8 – M12

Anchor size		VMZ-A	40 M8	50 M8	60 M10	75 M10	75 M12	70 M12	80 M12	95 M12	100 M12	110 M12	125 M12
Minimum thickness of concrete	h_{min}	[mm]	80	80	100	110 100 ¹⁾	110	110	110	130 125 ¹⁾	130	140	160
Cracked concrete													
Minimum spacing	s_{min}	[mm]	40	40	40	40	50	55	40	40	50	50	50
Minimum edge distance	c_{min}	[mm]	40	40	40	40	50	55	50	50	50	50	50
Uncracked concrete													
Minimum spacing	s_{min}	[mm]	40	40	50	50	50	55	55	55	80 ²⁾	80 ²⁾	80 ²⁾
Minimum edge distance	c_{min}	[mm]	40	40	50	50	50	55	55	55	55 ²⁾	55 ²⁾	55 ²⁾

Table B6: Minimum spacing and edge distance, VMZ-A M16 – M24

Anchor size		VMZ-A	90 M16	105 M16	125 M16	145 M16	160 M16	115 M20	170 M20 (LG)	190 M20 (LG)	170 M24 (LG)	200 M24 (LG)	225 M24 (LG)
Minimum thickness of concrete	h_{min}	[mm]	130	150	170 160 ¹⁾	190 180 ¹⁾	205 200 ¹⁾	160	230 220 ¹⁾	250 240 ¹⁾	230 220 ¹⁾	270 260 ¹⁾	300 290 ¹⁾
Cracked concrete													
Minimum spacing	s_{min}	[mm]	50	50	60	60	60	80	80	80	80	80	80
Minimum edge distance	c_{min}	[mm]	50	50	60	60	60	80	80	80	80	80	80
Uncracked concrete													
Minimum spacing	s_{min}	[mm]	50	60	60	60	60	80	80	80	80	105	105
Minimum edge distance	c_{min}	[mm]	50	60	60	60	60	80	80	80	80	105	105

¹⁾ The reverse of the concrete member must not be damaged after drilling and must be filled with high-strength mortar if drilled through.

²⁾ For an edge distance $c \geq 80$ mm a minimum spacing $s_{min} = 55$ mm is applicable

Injection System VMZ

Intended use
Minimum spacing and edge distance, VMZ-A

Annex B5

Table B7: Installation parameters VMZ-IG

Anchor size		VMZ-IG	40 M6	50 M6	60 M8	75 M8	70 M10	80 M10	90 M12	105 M12	125 M12	115 M16	170 M16	170 M20
Effective anchorage depth	h_{ef}	[mm]	40	50	60	75	70	80	90	105	125	115	170	170
Nominal diameter of drill hole	d_0	[mm]	10	10	12	12	14	14	18	18	18	22	24	26
Depth of drill hole	$h_0 \geq$	[mm]	42	55	65	80	80	85	98	113	133	120	180	185
Diameter of cleaning brush	$D \geq$	[mm]	10,8	10,8	13,0	13,0	15,0	15,0	19,0	19,0	19,0	23,0	25,0	27,0
Installation torque	$T_{inst} \leq$	[Nm]	8	8	10	10	15	15	25	25	25	50	50	80
Diameter of clearance hole in the fixture	$d_f \leq$	[mm]	7	7	9	9	12	12	14	14	14	18	18	22
Available thread length	L_{th}	[mm]	12	15	16	19	20	23	24	27	30	32	32	40
Minimum screw-in depth	L_{sdmin}	[mm]	7	7	9	9	12	12	14	14	14	18	18	22
Minimum thickness of concrete	h_{min}	[mm]	80	80	100	110	110	110	130	150	170 160 ¹⁾	160	230 220 ¹⁾	230 220 ¹⁾
Cracked concrete														
Minimum spacing	s_{min}	[mm]	40	40	40	40	55	40	50	50	60	80	80	80
Minimum edge distance	c_{min}	[mm]	40	40	40	40	55	50	50	50	60	80	80	80
Uncracked concrete														
Minimum spacing	s_{min}	[mm]	40	40	50	50	55	55	50	60	60	80	80	80
Minimum edge distance	c_{min}	[mm]	40	40	50	50	55	55	50	60	60	80	80	80

¹⁾ The reverse of the concrete member must not be damaged after drilling.

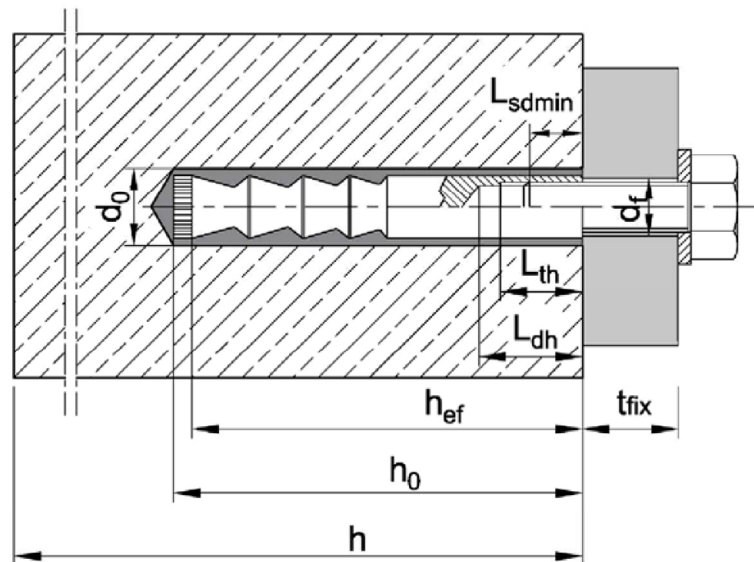

Injection System VMZ

Intended use
Installation parameters **VMZ-IG**

Annex B6

Installation instructions - Hammer drill bit

Hammer drill bit

Hole drilling

1		Use hammer drill or compressed air drill with drill bit and depth gauge. Drill perpendicular to concrete surface.
---	--	---

Cleaning

Cleaning with compressed air (all sizes)

2a		Connect Air Blower to compressed air (min. 6 bar, oil-free). Open air valve and blow out drill hole along the entire depth with back and forth motion at least two times.
----	--	---

3a		Check diameter of cleaning brush. If the brush can be pushed into the drill hole without any resistance, it must be replaced. Chuck brush into drill machine. Turn on drill machine and brush drill hole back and forth along the entire drill hole depth at least two times while rotated by drill machine.
----	--	--

4a		Connect Air Blower to compressed air (min. 6 bar, oil-free). Open air valve and blow out drill hole along the entire depth with back and forth motion at least two times.
----	--	---

Manual cleaning (alternatively, up to drill hole diameter 18mm)

2b		Blow out drill hole from the bottom with Blow-out pump at least two times.
----	--	--

3b		Check diameter of cleaning brush. If the brush can be pushed into the drill hole without any resistance, it must be replaced. Chuck brush into drill machine. Turn on drill machine and brush drill hole back and forth along the entire drill hole depth at least two times while rotated by drill machine.
----	--	--

4b		Blow out drill hole from the bottom with Blow-out pump at least two times.
----	--	--

Injection System VMZ

Intended use
 Installation instructions
 Hole drilling and cleaning (hammer drill bit)

Annex B7

Installation instructions - Vacuum drill bit

Vacuum drill bit

Hole drilling and cleaning

1

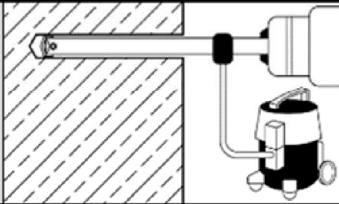

Drill hole perpendicular to concrete surface by using a vacuum drill bit (see Annex B1). The nominal underpressure of the vacuum cleaner must be at least 230 mbar / 23kPa.

Pay attention to the function of the dust extraction system!

Make sure the dust extraction is working properly throughout the whole drilling process.

Additional cleaning is not necessary - continue with step 5!

Installation instructions - Diamond drilling

Diamond drilling

Hole drilling

1

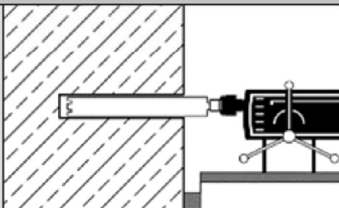

Use diamond drill with diamond drill bit and depth gauge. Drill perpendicular to concrete surface.

Cleaning

2

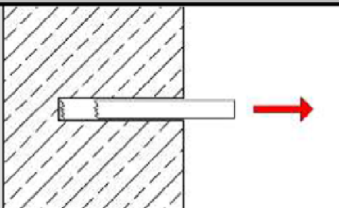

Remove drill core at least up to the nominal hole depth and check drill hole depth.

3

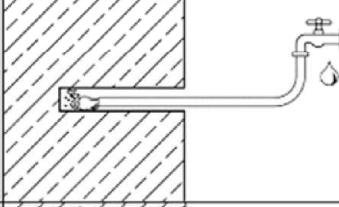

Flushing of drill hole:

Flush drill hole with water, starting from the bottom, until clear water gets out of the drill hole.

4

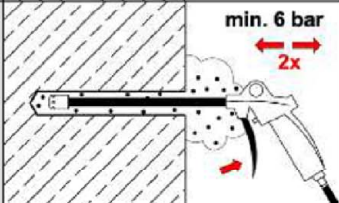

Connect Air Blower to compressed air (min. 6 bar, oil-free).

Open air valve and blow out drill hole along the entire depth with back and forth motion at least two times.

Injection System VMZ

Intended use

Installation instructions

Hole drilling and cleaning (vacuum drill bit and diamond drill bit)

Annex B8

Installation instructions - Continuation

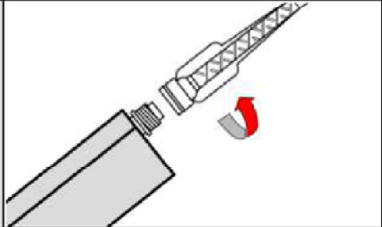
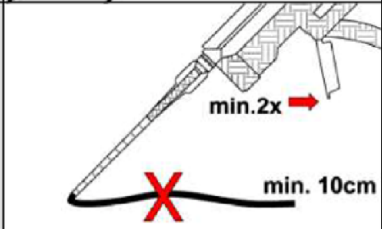
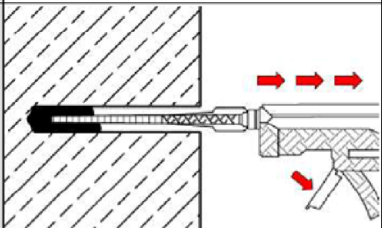
Injection		
5		<p>Check expiration date on cartridge. Never use when expired. Remove cap from cartridge. Attach the supplied static mixer to the cartridge. For every working interruption longer than the recommended working time (Table B1 or Table B2) as well as for a new cartridge always use a new static mixer. Never use static mixer without helix inside.</p>
6		<p>Insert cartridge in Dispenser. Before injecting discard mortar (at least 2 full strokes or a line of 10 cm) until it shows a consistent grey colour. Never use this mortar.</p>
7		<p>Prior to injection, check if static mixer reaches the bottom of the drill hole. If it does not reach the bottom, plug Mixer Extension onto static mixer in order to fill the drill hole properly. Fill hole with a sufficient quantity of injection mortar. Start from the bottom of the drill hole and work out to avoid trapping air pockets.</p>

Injection System VMZ

Intended use
Installation instructions
Injection

Annex B9

Installation instructions - Continuation

Anchor rod VMZ-A

Inserting the anchor rod

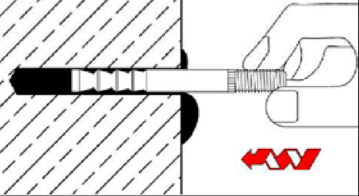
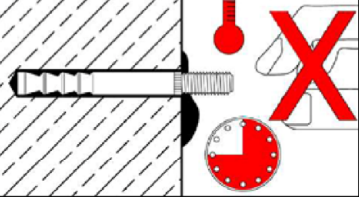
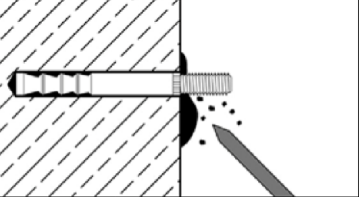
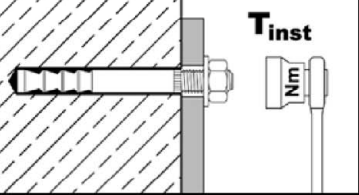
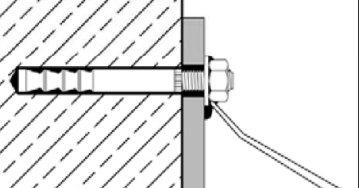
8		<p>Insert the anchor rod VMZ-A by hand, rotating slightly up to the full embedment depth as marked on the anchor rod. The anchor rod is properly set when excess mortar seeps from the hole (Pre-setting installation) or the annular gap in the clearance hole in the fixture is completely filled by excess mortar (Through-setting installation). If the hole is not completely filled, pull out anchor rod, let mortar cure, drill out hole and repeat entire cleaning process.</p>
9		<p>Follow minimum curing time shown in Table B1 or Table B2. During curing time, anchor rod must not be moved or loaded.</p>
10		<p>Remove excess mortar.</p>
11		<p>The fixture can be mounted after curing time. Apply installation torque T_{inst} according to Table B3 or Table B4 by using torque wrench.</p>
<h4>Filling annular gap</h4>		
Optional		<p>Annular gap between anchor rod and attachment may optionally be filled with mortar. Therefore, replace regular washer by washer with bore and plug on reducing adapter on static mixer. Annular gap is completely filled, when excess mortar seeps out.</p>

Injection System VMZ

Intended use
 Installation instructions
 Installation Anchor rod VMZ-A

Annex B10

Installation instructions – Stand-off Installation

Stand-off installation with Anchor rod VMZ-A 75 M12

Requirement: Diameter of clearance hole in the fixture $d_f \leq 14 \text{ mm}$

Work step 1-7 as illustrated in Annexes B7 – B9

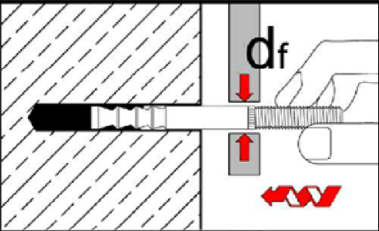
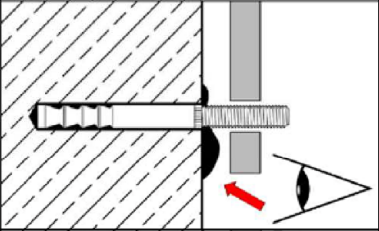
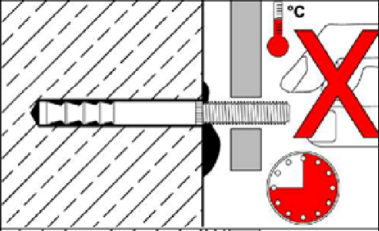
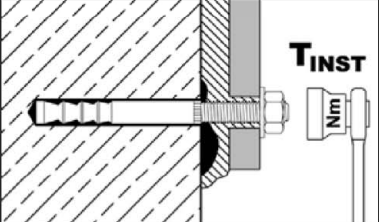
8		<p>Insert the anchor rod VMZ-A by hand, rotating slightly up to the full embedment depth.</p>
9		<p>Check if excess mortar seeps from the hole. If the hole is not completely filled, pull out anchor rod, let mortar cure, drill out hole and repeat the entire cleaning process.</p> <p>The annular gap in the fixture does not have to be filled.</p>
10		<p>During curing time according to Table B1 or Table B2 anchor rod must not be moved or loaded.</p>
11		<p>Washer and nut can be mounted after curing time and backfilling of anchor plate. Apply installation torque T_{inst} according to Table B3 by using torque wrench.</p>

Injection System VMZ

Intended use

Installation instructions VMZ-A 75 M12

Through-setting installation with clearance between concrete and anchor plate

Annex B11

Installation instructions - Continuation

Anchor rod VMZ-IG

Setting of anchor

Work step 1-7 as illustrated in Annexes B7 – B9

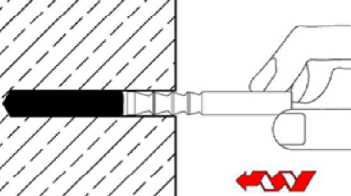
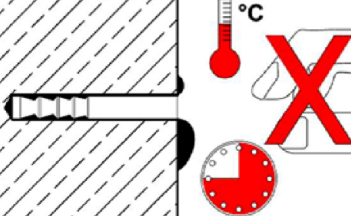
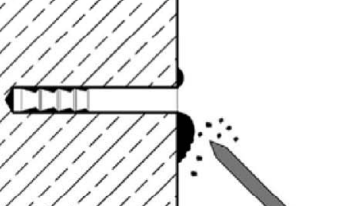
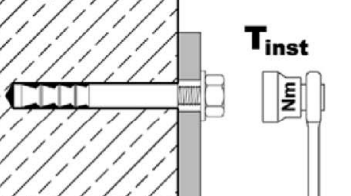
8		<p>Insert the anchor rod VMZ-IG by hand, rotating slightly up to about 1 mm below the concrete surface in the drill hole. The anchor rod is properly set when excess mortar seeps from the hole. If the hole is not completely filled, pull out anchor rod, let mortar cure, drill out hole and repeat the entire cleaning process.</p>
9		<p>Follow minimum curing time shown in Table B1 and Table B2. During curing time anchor rod must not be moved or loaded.</p>
10		<p>Remove excess mortar.</p>
11		<p>The fixture can be mounted after curing time. Apply installation torque T_{inst} according to Table B7 by using torque wrench.</p>

Injection System VMZ

Intended use

Installation instructions
Anchor installation VMZ-IG

Annex B12

Table C1: Characteristic values for concrete failure and splitting

Anchor size		VMZ-A VMZ-IG	all sizes	
Concrete cone failure				
Factor for k_1	<u>uncracked</u> concrete	$k_{ucr,N}$	[-]	11,0
	<u>cracked</u> concrete	$k_{cr,N}$	[-]	7,7
Characteristic edge distance		$c_{cr,N}$	[mm]	$1,5 \cdot h_{ef}$
Characteristic spacing		$s_{cr,N}$	[mm]	$2 \cdot c_{cr,N}$
Splitting				
For each proof of splitting failure, $N_{Rk,sp}$ shall be calculated according to EN 1992-4:2018, equation (7.23). The higher value for $N_{Rk,sp}$ of case 1 and case 2 may be applied for the design.				
Case 1				
Characteristic resistance		$N^0_{Rk,sp}$	[kN]	see following tables
Characteristic edge distance		$c_{cr,sp}$	[mm]	$1,5 \cdot h_{ef}$
Characteristic spacing		$s_{cr,sp}$	[mm]	$2 \cdot c_{cr,sp}$
Case 2				
Characteristic resistance		$N^0_{Rk,sp}$	[kN]	min [$N_{Rk,p}$; $N^0_{Rk,c}$]
Characteristic edge distance		$c_{cr,sp}$	[mm]	see following tables
Characteristic spacing		$s_{cr,sp}$	[mm]	$2 \cdot c_{cr,sp}$

Injection System VMZ

Performance
Characteristic values for **concrete failure and splitting, VMZ-A and VMZ-IG**

Annex C1

Table C2: Characteristic values for tension loads, VMZ-A M8 – M12, static and quasi-static action

Anchor size		VMZ-A	40 M8	50 M8	60 M10	75 M10	75 M12	70 M12	80 M12	95 M12	100 M12	110 M12	125 M12	
Installation factor	γ_{inst}	[-]	1,0											
Steel failure														
Characteristic resistance	$N_{Rk,s}$	[kN]	15	18	25	35	49	54	57					
Partial factor	γ_{Ms}	[-]	1,5											
Pull-out														
Characteristic resistance (concrete C20/25)														
uncracked concrete	50°C / 80°C ¹⁾	$N_{Rk,p}$	[kN]	9	17,4	22,9	32,0	32,0	28,8	35,2	40	49,2	50	50
	72°C / 120°C ¹⁾		[kN]	6	9	16	16	16	16	25	25	30	30	30
cracked concrete	50°C / 80°C ¹⁾	$N_{Rk,p}$	[kN]	8,7	12,2	16,0	22,4	22,4	20,2	24,6	31,9	34,4	39,7	48,1
	72°C / 120°C ¹⁾		[kN]	5	7,5	12	12	12	16	20	20	30	30	30
Splitting														
Splitting for standard thickness of concrete member														
Standard thickness of concrete	$h_{min,1} \geq$	[mm]	100	120	150	150	140	160	190	200	220	250		
Case 1														
Characteristic resistance (concrete C20/25)	$N^0_{Rk,sp}$	[kN]	7,5	9	16	20	20	35,2	30	40				
Case 2														
Characteristic edge distance	$c_{cr,sp}$	[mm]	3 h_{ef}	2,5 h_{ef}	3,5 h_{ef}	3,5 h_{ef}	2,5 h_{ef}	1,5 h_{ef}	2,5 h_{ef}	2 h_{ef}	3 h_{ef}	2,5 h_{ef}		
Splitting for minimum thickness of concrete member														
Minimum thickness of concrete	$h_{min,2} \geq$	[mm]	80	100	110			125	130	140	160			
Case 1														
Characteristic resistance (concrete C20/25)	$N^0_{Rk,sp}$	[kN]	7,5	2)	16	16	20	25	25	30				
Case 2														
Characteristic edge distance	$c_{cr,sp}$	[mm]	3 h_{ef}	3,5 h_{ef}	3 h_{ef}	3,5 h_{ef}	3,5 h_{ef}	3 h_{ef}	3,5 h_{ef}	3 h_{ef}				
Increasing factor for $N_{Rk,p}$ and $N^0_{Rk,sp}$ (Case 1)	ψ_c	[-]	$\left(\frac{f_{ck}}{20}\right)^{0,5}$											
Concrete cone failure														
Effective anchorage depth	h_{ef}	[mm]	40	50	60	75	75	70	80	95	100	110	125	

¹⁾ Maximum long-term temperature / Maximum short-term temperature

²⁾ No performance assessed

Injection System VMZ

Performance

Characteristic values for tension loads, VMZ-A M8 – M12, static and quasi-static action

Annex C2

Table C3: Characteristic values for tension loads, VMZ-A M16 – M24, static and quasi-static action

Anchor size		VMZ-A	90 M16	105 M16	125 M16	145 M16	160 M16	115 M20	170 M20 (LG)	190 M20 (LG)	170 M24 (LG)	200 M24 (LG)	225 M24 (LG)	
Installation factor	γ_{inst}	[-]	1,0											
Steel failure														
Characteristic tension resistance $N_{Rk,s}$	Steel, zinc plated	[kN]	88	95	111		97	96	188		222			
	A4, HCR	[kN]	88	95	111		97	114	165		194			
Partial factor	γ_{Ms}	[-]	1,5					1,68	1,5		1,5			
Pull-out														
Characteristic resistance (concrete C20/25)														
uncracked concrete	50°C/80°C ¹⁾ 72°C/120°C ¹⁾	$N_{Rk,p}$	[kN]	42,0	52,9	68,8	75	90	60,7	109,0	128,8	109,0	139,1	166,0
			[kN]	25	35	50		53	40	75		95		
cracked concrete	50°C/80°C ¹⁾ 72°C/120°C ¹⁾	$N_{Rk,p}$	[kN]	29,4	37,1	48,1	60,1	69,7	42,5	76,3	90,2	76,3	97,4	116,2
			[kN]	25	30	50		51	30	60		75		
Splitting														
Splitting for standard thickness of concrete														
Standard thickness of concrete	$h_{min,1} \geq$	[mm]	180	200	250	290	320	230	340	380	340	400	450	
Case 1														
Characteristic resistance (concrete C20/25)	$N^0_{Rk,sp}$	[kN]	40	50		60	80	60,7	109	115	109	139,1	140	
Case 2														
Characteristic edge distance	$c_{cr,sp}$	[mm]	2 h_{ef}					1,5 h_{ef}		2 h_{ef}	1,5 h_{ef}		1,8 h_{ef}	
Splitting for minimum thickness of concrete														
Minimum thickness of concrete	$h_{min,2} \geq$	[mm]	130	150	160	180	200	160	220	240	220	260	290	
Case 1														
Characteristic resistance (concrete C20/25)	$N^0_{Rk,sp}$	[kN]	35	50	40	50	71	2)	75		109	115		
Case 2														
Characteristic edge distance	$c_{cr,sp}$	[mm]	2,5 h_{ef}		3 h_{ef}	2,5 h_{ef}		2,5 h_{ef}	2,6 h_{ef}	2,2 h_{ef}	2,6 h_{ef}	2,2 h_{ef}		
Increasing factor for $N_{Rk,p}$ and $N^0_{Rk,sp}$ (Case 1)	ψ_c	[-]	$\left(\frac{f_{ck}}{20}\right)^{0,5}$											
Concrete cone failure														
Effective anchorage depth	h_{ef}	[mm]	90	105	125	145	160	115	170	190	170	200	225	

¹⁾ Maximum long-term temperature / Maximum short-term temperature

²⁾ No performance assessed

Injection System VMZ

Performance

Characteristic values for tension loads, VMZ-A M16 – M24, static and quasi-static action

Annex C3

Table C4: Characteristic values for shear load, VMZ-A M8 – M12, static and quasi-static action

Anchor size		VMZ-A	40 M8	50 M8	60 M10	75 M10	75 M12	70 M12	80 M12	95 M12	100 M12	110 M12	125 M12
Installation factor	γ_{inst}	[-]	1,0										
Steel failure without lever arm													
Characteristic resistance $V^{0}_{Rk,s}$	Steel, zinc plated	[kN]	14		21		34						
	A4, HCR	[kN]	15		23		34						
Partial factor	γ_{Ms}	[-]	1,25										
Factor for ductility	k_7	[-]	1,0										
Steel failure with lever arm													
Characteristic bending resistance $M^{0}_{Rk,s}$	Steel, zinc plated	[Nm]	30		60		105						
	A4, HCR	[Nm]	30		60		105						
Partial factor	γ_{Ms}	[-]	1,25										
Concrete pry-out failure													
Pry-out factor	k_8	[-]	2										
Concrete edge failure													
Effective length of anchor in shear load	l_f	[mm]	40	50	60	75	75	70	80	95	100	110	125
Diameter of anchor	d_{nom}	[mm]	10		12		12	14					

Injection System VMZ

Performance
 Characteristic values for shear load, VMZ-A M8 – M12, static and quasi-static action

Annex C4

Table C5: Characteristic values for shear load, VMZ-A M16 – M24, static or quasi-static action

Anchor size		VMZ-A	90 M16	105 M16	125 M16	145 M16	160 M16	115 M20	170 M20 (LG)	190 M20 (LG)	170 M24 (LG)	200 M24 (LG)	225 M24 (LG)
Installation factor	γ_{inst}	[-]	1,0										
Steel failure without lever arm													
Characteristic resistance $V_{Rk,s}^0$	Steel, zinc plated	[kN]	63				70	149 ¹⁾ (98)		178 ¹⁾ (141)			
	A4, HCR	[kN]	63				86	131 ¹⁾ (86)		156 ¹⁾ (123)			
Partial factor	γ_{Ms}	[-]	1,25				1,4	1,25		1,25			
Factor for ductility	k_7	[-]	1,0										
Steel failure with lever arm													
Characteristic bending resistance $M_{Rk,s}^0$	Steel, zinc plated	[Nm]	266				392	519		896			
	A4, HCR	[Nm]	266				454		784				
Partial factor	γ_{Ms}	[-]	1,25				1,4	1,25		1,25			
Concrete pry-out failure													
Pry-out factor	k_8	[-]	2,0										
Concrete edge failure													
Effective length of anchor in shear load	l_f	[mm]	90	105	125	145	160	115	170	190	170	200	225
Diameter of anchor	d_{nom}	[mm]	18				22	24		26			

¹⁾ This value may only be applied if $l_t \geq 0,5 t_{fix}$

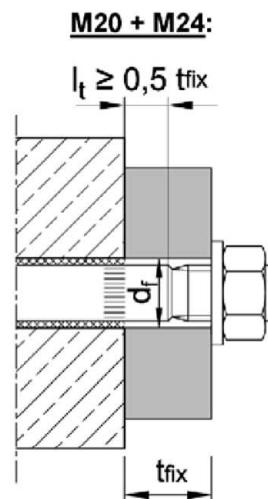

Injection System VMZ

Performance

Characteristic values for shear load, VMZ-A M16 – M24, static and quasi-static action

Annex C5

**Table C6: Characteristic values for seismic action,
VMZ-A M10 – M12 performance category C1 and C2**

Anchor size		VMZ-A	60 M10	75 M10	75 M12	70 M12	80 M12	95 M12	100 M12	110 M12	125 M12	
Tension loads												
Installation factor		γ_{inst}	[-]		1,0							
Steel failure, steel zinc plated, stainless steel A4, HCR												
Characteristic resistance		$N_{Rk,s,C1}$ $N_{Rk,s,C2}$	[kN]		25	35	49	54	57			
Partial factor		γ_{Ms}	[-]		1,5							
Pull-out (concrete C20/25 to C50/60)												
Characteristic resistance		$N_{Rk,p,C1}$	50°C / 80°C ¹⁾	[kN]		14,5	14,5	30,6	36,0	41,5	42,8	
			72°C / 120°C ¹⁾	[kN]		10,9	10,9	20,0	30,0			
		$N_{Rk,p,C2}$	50°C / 80°C ¹⁾	[kN]		7,4	7,4	8,7	17,6			
			72°C / 120°C ¹⁾	[kN]		5,1	5,1	6,5	12,3			

Shear loads											
Steel failure without lever arm, steel zinc plated											
Characteristic resistance		$V_{Rk,s,C1}$	[kN]		11,8	27,2					
		$V_{Rk,s,C2}$	[kN]		12,6	27,2					
Partial factor		γ_{Ms}	[-]		1,25						
Steel failure without lever arm, stainless steel A4, HCR											
Characteristic resistance		$V_{Rk,s,C1}$	[kN]		12,9	27,2					
		$V_{Rk,s,C2}$	[kN]		13,8	27,2					
Partial factor		γ_{Ms}	[-]		1,25						
Factor for anchorages with		filled annular gap	α_{gap}	[-]		1,0					
		unfilled annular gap	α_{gap}	[-]		0,5					

¹⁾ Maximum long-term temperature / Maximum short-term temperature

Injection System VMZ								Annex C6			
Performance Characteristic values for seismic action, VMZ-A M10 – M12, performance category C1 and C2											

**Table C7: Characteristic values for seismic action,
VMZ-A M16 – M24, performance category C1 and C2**

Anchor size		VMZ-A	90 M16	105 M16	125 M16	145 M16	160 M16	115 M20	170 M20 (LG)	190 M20 (LG)	170 M24 (LG)	200 M24 (LG)	225 M24 (LG)
Tension loads													
Installation factor		γ_{inst}	[-]		1,0								
Steel failure, steel zinc plated													
Characteristic resistance		$N_{Rk,s,C1}$ $N_{Rk,s,C2}$	[kN]	88	95	111	97	96	188	222			
Steel failure, stainless steel A4, HCR													
Characteristic resistance		$N_{Rk,s,C1}$ $N_{Rk,s,C2}$	[kN]	88	95	111	97	114	165	194			
Partial factor		γ_{Ms}	[-]		1,5			1,68	1,5	1,5			
Pull-out (concrete C20/25 to C50/60)													
Charac- teristic resistance	$N_{Rk,p,C1}$	50°C / 80°C ¹⁾	[kN]	30,7	38,7	43,7		44,4	88,2	90,7			
		72°C / 120°C ¹⁾	[kN]	25,0	30,0	38,5		29,4	55,8	59,3			
	$N_{Rk,p,C2}$	50°C / 80°C ¹⁾	[kN]	16,3	22,1	26,1		30,9	59,7	59,7			
		72°C / 120°C ¹⁾	[kN]	10,5	14,4	19,5		16,2	44,4	44,4			
Shear loads													
Steel failure without lever arm, steel zinc plated													
Characteristic resistance		$V_{Rk,s,C1}$ $V_{Rk,s,C2}$	[kN]	39,1			39,1	82,3	107				
			[kN]	50,4			51	108,8 ¹⁾ (71,5)	154,9 ¹⁾ (122,7)				
Partial factor		γ_{Ms}	[-]		1,25			1,4	1,25	1,25			
Steel failure without lever arm, stainless steel A4, HCR													
Characteristic resistance		$V_{Rk,s,C1}$ $V_{Rk,s,C2}$	[kN]	39,1			39,1	72,2	93				
			[kN]	50,4			62,6	95,6 ¹⁾ (62,8)	135,7 ¹⁾ (107)				
Partial factor		γ_{Ms}	[-]		1,25			1,4	1,25	1,25			
Factor for anchorage with	filled annular gap	α_{gap}	[-]		1,0								
	unfilled annular gap	α_{gap}	[-]		0,5								

¹⁾ This value may only be applied if $l_t \geq 0,5 t_{fix}$. (see Annex C4)

Injection System VMZ

Performance

Characteristic values for **seismic action, VMZ-A M16 – M24,**
performance category **C1 and C2**

Annex C7

Table C8: Displacements under tension loads, VMZ-A M8 – M12

Anchor size		VMZ-A	40 M8	50 M8	60 M10	75 M10	75 M12	70 M12	80 M12	95 M12	100 M12	110 M12	125 M12
Tension load in cracked concrete	N	[kN]	4,3	6,1	8,0	11,1	11,1	10,0	12,3	15,9	17,1	19,8	24,0
Displacement	δ_{N0}	[mm]	0,5		0,5	0,6	0,6				0,7		
	$\delta_{N\infty}$	[mm]	1,3										
Tension load in uncracked concrete	N	[kN]	4,3	8,5	11,1	15,6	15,6	14,1	17,2	19,0	24,0	23,8	23,8
Displacement	δ_{N0}	[mm]	0,2	0,4	0,4		0,4				0,6		
	$\delta_{N\infty}$	[mm]	1,3										
Displacements under seismic tension loads C2													
Displacements for DLS	$\delta_{N,C2(DLS)}$	[mm]	no perfor-		1,0		1,0		1,3		1,1		
Displacements for ULS	$\delta_{N,C2(ULS)}$	[mm]	mance		3,0		3,0		3,9		3,0		
			assessed										

Table C9: Displacements under tension loads, VMZ-A M16 – M24

Anchor size		VMZ-A	90 M16	105 M16	125 M16	145 M16	160 M16	115 M20	170 M20 (LG)	190 M20 (LG)	170 M24 (LG)	200 M24 (LG)	225 M24 (LG)
Tension load in cracked concrete	N	[kN]	14,6	18,4	24,0	30,0	34,7	21,1	38,0	44,9	38,0	48,5	57,9
Displacement	δ_{N0}	[mm]	0,7			0,8	1,2	0,7	0,8		0,8	0,9	
	$\delta_{N\infty}$	[mm]	1,3				1,6	1,1	1,3		1,3		
Tension load in uncracked concrete	N	[kN]	20,5	25,9	33,0	35,7	48,1	29,6	53,3	63,0	53,3	67,9	81,1
Displacement	δ_{N0}	[mm]	0,6				0,8	0,5	0,6		0,6		
	$\delta_{N\infty}$	[mm]	1,3				1,6	1,1	1,3		1,3		
Displacements under seismic tension loads C2													
Displacements for DLS	$\delta_{N,C2(DLS)}$	[mm]	1,6		1,5			1,7	1,9		1,9		
Displacements for ULS	$\delta_{N,C2(ULS)}$	[mm]	3,7		4,4			4,0	4,5		4,5		

Injection System VMZ

Performance
Displacements under tension loads, **VMZ-A**

Annex C8

Table C10: Displacements under shear loads VMZ-A M8 – M12

Anchor size		VMZ-A	40 M8	50 M8	60 M10	75 M10	75 M12	70 M12	80 M12	95 M12	100 M12	110 M12	125 M12
Shear load	V	[kN]	8,3		13,3		19,3						
Displacements	δ_{V0}	[mm]	2,4	2,5	2,9		3,3						
	$\delta_{V\infty}$	[mm]	3,6	3,8	4,4		5,0						
Displacements under seismic shear loads C2													
Displacements for DLS	$\delta_{V,C2(DLS)}$	[mm]	no performance assessed		2,1		2,5						
Displacements for ULS	$\delta_{V,C2(ULS)}$	[mm]			3,7		5,1						

Table C11: Displacements under shear loads VMZ-A M16 – M24

Anchor size		VMZ-A	90 M16	105 M16	125 M16	145 M16	160 M16	115 M20	170 M20 (LG)	190 M20 (LG)	170 M24 (LG)	200 M24 (LG)	225 M24 (LG)
Shear load	V	[kN]	36					44	75 (49)		89 (71)		
Displacements	δ_{V0}	[mm]	3,8					3,0	4,3 (3,0)		4,6 (3,5)		
	$\delta_{V\infty}$	[mm]	5,7					4,5	6,5 (4,5)		6,9 (5,3)		
Displacements under seismic shear loads C2													
Displacements for DLS	$\delta_{V,C2(DLS)}$	[mm]	2,9					3,5		3,7			
Displacements for ULS	$\delta_{V,C2(ULS)}$	[mm]	6,8					9,3		9,3			

Injection System VMZ

Performance
Displacements under shear loads, **VMZ-A**

Annex C9

Table C12: Characteristic values for tension load, VMZ-IG

Anchor size		VMZ-IG	40 M6	50 M6	60 M8	75 M8	70 M10	80 M10	90 M12	105 M12	125 M12	115 M16	170 M16	170 M20	
Installation factor	γ_{inst}	[-]	1,0												
Steel failure															
Characteristic resistance $N_{Rk,s}$	Steel, zinc plated	[kN]	15	16	19	29	35		67		52	125	108		
	A4, HCR	[kN]	11		19	21	33		47		65	88	94		
Partial factor	γ_{Ms}	[-]	1,5												
Pull-out															
Characteristic resistance (concrete C20/25)															
uncracked concrete	50°C / 80°C ¹⁾	$N_{Rk,p}$	[kN]	9	17,4	22,9	32	28,8	35,2	42	52,9	68,8	60,7	109	109
	72°C / 120°C ¹⁾		[kN]	6	9	16	16	16	25	25	35	50	40	75	95
cracked concrete	50°C / 80°C ¹⁾	$N_{Rk,p}$	[kN]	8,7	12,2	16	22,4	20,2	24,6	29,4	37,1	48,1	42,5	76,3	76,3
	72°C / 120°C ¹⁾		[kN]	5	7,5	12	12	16	20	20	30	50	30	60	75
Splitting															
Splitting for standard thickness of concrete															
Standard thickness of concrete	$h_{min,1} \geq$	[mm]	100	120	150	140	160	180	200	250	230	340	340		
Case 1															
Characteristic resistance (concrete C20/25)	$N^0_{Rk,sp}$	[kN]	7,5	9	16	20	20	35,2	40	50	50	60,7	109	109	
Case 2															
Characteristic edge distance	$c_{cr,sp}$	[mm]	3 h_{ef}		2,5 h_{ef}	3,5 h_{ef}	2,5 h_{ef}	1,5 h_{ef}	2 h_{ef}			1,5 h_{ef}	1,5 h_{ef}		
Splitting for minimum thickness of concrete															
Minimum thickness of concrete	$h_{min,2} \geq$	[mm]	80	100	110	110		130	150	160	160	220	220		
Case 1															
Characteristic resistance (concrete C20/25)	$N^0_{Rk,sp}$	[kN]	7,5	²⁾	16	20	25	35	50	40	²⁾	75	109		
Case 2															
Characteristic edge distance	$c_{cr,sp}$	[mm]	3 h_{ef}	3,5 h_{ef}	3 h_{ef}	3,5 h_{ef}	3,5 h_{ef}	3 h_{ef}	2,5 h_{ef}	2,5 h_{ef}	3 h_{ef}	2,5 h_{ef}	2,6 h_{ef}	2,6 h_{ef}	
Increasing factor for $N_{Rk,p}$ and $N^0_{Rk,sp}$ (case 1)	ψ_c	[-]	$\left(\frac{f_{ck}}{20}\right)^{0,5}$												
Concrete cone failure															
Effective anchorage depth	h_{ef}	[mm]	40	50	60	75	70	80	90	105	125	115	170	170	

¹⁾ Maximum long-term temperature / Maximum short-term temperature

²⁾ No performance assessed

Injection System VMZ
Performance

Characteristic values for tension loads, VMZ-IG

Annex C10

Table C13: Characteristic values for shear load, VMZ-IG

Anchor size		VMZ-IG	40 M6	50 M6	60 M8	75 M8	70 M10	80 M10	90 M12	105 M12	125 M12	115 M16	170 M16	170 M20
Installation factor	γ_{inst}	[-]	1,0											
Steel failure without lever arm														
Characteristic resistance $V_{0RK,s}$	Steel, zinc plated	[kN]	8,0	9,5	15	18	34			26	63	54		
	A4, HCR	[kN]	5,5	9,5	10	16	24			32	44	47		
Partial factor	γ_{Ms}	[-]	1,25											
Ductility factor	k_7	[-]	1,0											
Steel failure with lever arm														
Characteristic bending resistance $M_{0RK,s}$	Steel, zinc plated	[kN]	12	30	60	105			212	266	519			
	A4, HCR	[kN]	8,5	21	42	74			187	187	365			
Partial factor	γ_{Ms}	[-]	1,25											
Concrete pry-out failure														
Pry-out factor	k_8	[-]	2,0											
Concrete edge failure														
Effective length of anchor in shear load	l_f	[mm]	40	50	60	75	70	80	90	105	125	115	170	170
Outside diameter of anchor	d_{nom}	[mm]	10	12	14	18			22	24	26			

Table C14: Displacements under tension loads, VMZ-IG

Anchor size		VMZ-IG	40 M6	50 M6	60 M8	75 M8	70 M10	80 M10	90 M12	105 M12	125 M12	115 M16	170 M16	170 M20
Tension load in cracked concrete	N	[kN]	4,3	6,1	8,0	11,1	10,0	12,3	14,6	18,4	24,0	21,1	38,0	38,0
Displacement	δ_{N0}	[mm]	0,5	0,5	0,6	0,6			0,7			0,7	0,8	0,8
	$\delta_{N\infty}$	[mm]	1,3									1,1	1,3	1,3
Tension load in uncracked concrete	N	[kN]	4,3	8,5	11,1	15,6	14,1	17,2	20,5	25,9	33,0	29,6	53,3	53,3
Displacement	δ_{N0}	[mm]	0,2	0,4	0,4		0,4		0,6			0,5	0,6	0,6
	$\delta_{N\infty}$	[mm]	1,3									1,1	1,3	1,3

Table C15: Displacements under shear loads, VMZ-IG

Anchor size		VMZ-IG	40 M6	50 M6	60 M8	75 M8	70 M10	80 M10	90 M12	105 M12	125 M12	115 M16	170 M16	170 M20
Shear load	V	[kN]	4,6	5,4	8,4	10,1			19,3			14,8	35,8	30,7
Displacement	δ_{V0}	[mm]	0,4	0,5	0,4	0,5			1,2			0,8	1,9	1,2
	$\delta_{V\infty}$	[mm]	0,7	0,8	0,7	0,8			1,9			1,2	2,8	1,9
Shear load	V	[kN]	3,2	5,4	5,9	9,3			13,5			18,5	25,2	26,9
Displacement	δ_{V0}	[mm]	0,3	0,5	0,3	0,5			0,9			1,0	1,4	1,1
	$\delta_{V\infty}$	[mm]	0,4	0,7	0,5	0,7			1,4			1,5	2,1	1,6

Injection System VMZ

Performance
Characteristic values for shear load VMZ-IG, Displacements VMZ-IG

Annex C11