



... eine starke Verbindung

## IZJAVA O LASTNOSTIH

DoP Št.: MKT-2.1-101\_sl

- ✧ **Enotna identifikacijska oznaka tipa proizvoda:** Injekcijski sistem VMZ
- ✧ **Predvidena uporaba:** Sidrno nadzorovano ekspanzijsko vezano sidro s sidrno palico VMZ-A in tulcem z notranjim navojem VMZ-IG za sidranje v beton, glej Priloga/Annex B
- ✧ **Proizvajalec:** MKT Metall-Kunststoff-Technik GmbH & Co.KG  
Auf dem Immel 2  
67685 Weilerbach
- ✧ **Sistemi ocenjevanja in preverjanja nespremenljivosti lastnosti:** 1
- ✧ **Evropski ocenjevalni dokument:** EAD 330499-01-0601  
Evropska tehnična ocena: ETA-04/0092, 04.08.2021  
Organ za tehnično ocenjevanje: DIBt, Berlin  
Priglašeni organi: NB 2873 – Technische Universität Darmstadt
- ✧ **Navedene lastnosti:**

Bistvene značilnosti	Lastnosti
<b>Mehanska odpornost in stabilnost (BWR 1)</b>	
Karakteristični upori pod natezno obremenitvijo (statični in kvazistatični učinki)	Priloga/Annex B5 – B6, C1 – C3, C10
Karakteristični upori pod prečnim stresom (statični in kvazistatični učinki)	Priloga/Annex C4 – C5, C11
Premiki	Priloga/Annex C8 – C9, C11
Karakteristična odpornost in premiki za seizmične zmogljivosti kategorije C1 + C2	Priloga/Annex C6 – C9
<b>Higiena, zdravje in okolje (BWR 3)</b>	
Vsebina, emisije in / ali sproščanje nevarnih snovi	Zmogljivost ni ocenjena

Lastnosti proizvoda, navedenega zgoraj, so v skladu z navedenimi lastnostmi. Za izdajo te izjave o lastnostih je v skladu z Uredbo (EU) št. 305/2011 odgovoren izključno proizvajalec, naveden zgoraj.

Podpisal za in v imenu proizvajalca:

  
**Stefan Weustenhagen**  
(Generalni direktor)  
Weilerbach, 04.08.2021

p.p.   
**Dipl.-Ing. Detlef Bigalke**  
(Vodja razvoja izdelkov)



Izvirnik te izjave o uspehu je bil napisan v nemškem jeziku. V primeru odstopanj v prevodu je nemška različica veljavna.

## Specifications of intended use

Injection System VMZ with anchor rod		VMZ-A	M8	M10	M12	M16	M20	M24
Static and quasi-static action					✓			
Seismic action (Category C1 + C2)			-	✓	✓	✓	✓	✓
Cracked or uncracked concrete					✓			
Strength classes acc. to EN 206-1:2013+A1:2016					C20/25 to C50/60			
Reinforced or unreinforced normal weight concrete acc. to EN 206-1: 2013+A1:2016					✓			
Temperature Range I	-40 °C to +80 °C				max. short term temperature +80 °C max. long term temperature +50 °C			
Temperature Range II	-40 °C to +120 °C				max. short term temperature +120 °C max. long term temperature +72 °C			
Making of drill hole	Hammer drill bit				✓			
	Vacuum drill bit <sup>1)</sup>	-	✓	✓	✓	✓	✓	✓
	Diamond drill bit (seismic action excluded)	-	✓	✓	✓	✓	✓	✓
Installation allowable in	dry concrete				✓			
	wet concrete				✓			
	water-filled hole	-	-	✓ <sup>2)</sup>	✓	✓	✓	✓
Overhead installation					✓			
Pre-setting installation					✓			
Trough-setting installation			-	✓	✓	✓	✓	✓

<sup>1)</sup> e.g. MKT vacuum drill bit, Würth hammer drill bit with suction or Heller Duster Expert

<sup>2)</sup> Exception: VMZ-A 75 M12 (Installation in water-filled drill hole is not allowed)

Injection System VMZ with anchor rod		VMZ-IG	M6	M8	M10	M12	M16	M20
Static and quasi-static action					✓			
Seismic action (Category C1 + C2)					-			
Cracked and uncracked concrete					✓			
Strength classes acc. to EN 206-1:2013+A1:2016					C20/25 to C50/60			
Reinforced or unreinforced normal weight concrete acc. to EN 206-1:2013+A1:2016					✓			
Temperature Range I	-40 °C to +80 °C				max. short term temperature +80 °C max. long term temperature +50 °C			
Temperature Range II	-40 °C to +120 °C				max. short term temperature +120 °C max. long term temperature +72 °C			
Making of drill hole	Hammer drill bit				✓			
	Vacuum drill bit <sup>1)</sup>	-	✓	✓	✓	✓	✓	✓
	Diamond drill bit	-	✓	✓	✓	✓	✓	✓
Installation allowable in	dry concrete				✓			
	wet concrete				✓			
	water-filled hole	-	-	✓	✓	✓	✓	✓
Overhead installation					✓			
Pre-setting installation					✓			

<sup>1)</sup> e.g. MKT vacuum drill bit, Würth hammer drill bit with suction or Heller Duster Expert

### Injection System VMZ

**Intended use**  
Specifications and installation conditions

**Annex B1**

## Specifications of intended use

### Use conditions (Environmental conditions):

- Structures subject to dry internal conditions: all versions VMZ-A and VMZ-IG
- For all other conditions:  
Intended use of materials according to Annex A3, Table A1 and Annex A5, Table A4 corresponding to the corrosion resistance class CRC to EN 1993-1-4:2015

### Design:

- Anchorages are designed under the responsibility of an engineer experienced in anchorages and concrete work.
- Verifiable calculation notes and drawings are prepared taking account of the loads to be anchored. The position of the anchor is indicated on the design drawings (e.g. position of the anchor relative to reinforcement or to supports, etc.).
- Anchorages are designed in accordance with EN 1992-4:2018 and Technical Report TR 055.

### Installation:

- Drill hole must be cleaned directly prior to installation of the anchor or the drill hole has to be protected against re-contamination in an appropriate way until dispensing the mortar in the drill hole.
- Water filled drill holes must not be polluted – otherwise the cleaning of the drill hole must be repeated.
- The anchor component installation temperature shall be at least +5 °C; during curing of the injection mortar the temperature of the concrete must not fall below -15 °C.
- It must be ensured that icing does not occur in the drill hole.
- Optionally, the annular gap between anchor rod and fixture may be filled with injection adhesive VMZ using the washer with bore (Part 2b, Annex A3) instead of the washer (Part 2a, Annex A3).

**Injection System VMZ**

**Intended use**  
Specifications

**Annex B2**

**Table B1: Working and curing time VMZ**

Temperature in the drill hole	Maximum working time	Minimum curing time dry concrete <sup>1)</sup>
- 15 °C to - 10 °C	45 min	7 d
- 9 °C to - 5 °C	45 min	10:30 h
- 4 °C to - 1 °C	45 min	6:00 h
0 °C to + 4 °C	20 min	3:00 h
+5 °C to + 9 °C	12 min	2:00 h
+10 °C to +19 °C	6 min	1:20 h
+20 °C to +29 °C	4 min	45 min
+30 °C to +34 °C	2 min	25 min
+35 °C to +39 °C	1,4 min	20 min
+ 40 °C	1,4 min	15 min
<b>Cartridge temperature</b>	<b>≥ 5°C</b>	

<sup>1)</sup> curing time in wet concrete shall be doubled

**Table B2: Working and curing time VMZ express**

Temperature in the drill hole	Maximum working time	Minimum curing time dry concrete <sup>1)</sup>
- 5 °C to - 1 °C	20 min	4:00 h
0 °C to + 4 °C	10 min	2:00 h
+ 5 °C to + 9 °C	6 min	1:00 h
+10 °C to +19 °C	3 min	40 min
+20 °C to +29 °C	1 min	20 min
+ 30 °C	1 min	10 min
<b>Cartridge temperature</b>	<b>≥ 5°C</b>	

<sup>1)</sup> Curing time in wet concrete shall be doubled

**Injection System VMZ**

**Intended use**  
Working and curing time

**Annex B3**



**Table B3: Installation parameters, VMZ-A M8 – M12**

Anchor size	VMZ-A	40 M8	50 M8	60 M10	75 M10	75 M12	70 M12	80 M12	95 M12	100 M12	110 M12	125 M12
Effective anchorage depth	$h_{ef} \geq$ [mm]	40	50	60	75	75	70	80	95	100	110	125
Nominal diameter of drill hole	$d_0 =$ [mm]	10	10	12	12	12	14	14	14	14	14	14
Depth of drill hole	$h_0 \geq$ [mm]	42	55	65	80	80	75	85	100	105	115	130
Diameter of cleaning brush	$D \geq$ [mm]	10,8	10,8	13,0	13,0	13,0	15,0	15,0	15,0	15,0	15,0	15,0
Installation torque	$T_{inst} \leq$ [Nm]	10	10	15	15	25	25	25	25	30	30	30
Diameter of clearance hole in the fixture												
Pre-setting installation	$d_f \leq$ [mm]	9	9	12	12	14	14	14	14	14	14	14
Through-setting installation	$d_f \leq$ [mm]	-	-	14	14	14 <sup>1)</sup> / 16	16	16	16	16	16	16

<sup>1)</sup> see Annex B11

**Table B4: Installation parameters, VMZ-A M16 – M24**

Anchor size	VMZ-A	90 M16	105 M16	125 M16	145 M16	160 M16	115 M20	170 M20 (LG)	190 M20 (LG)	170 M24 (LG)	200 M24 (LG)	225 M24 (LG)
Effective anchorage depth	$h_{ef} \geq$ [mm]	90	105	125	145	160	115	170	190	170	200	225
Nominal diameter of drill hole	$d_0 =$ [mm]	18	18	18	18	18	22	24	24	26	26	26
Depth of drill hole	$h_0 \geq$ [mm]	98	113	133	153	168	120	180	200	185	215	240
Diameter of cleaning brush	$D \geq$ [mm]	19,0	19,0	19,0	19,0	19,0	23,0	25,0	25,0	27,0	27,0	27,0
Installation torque	$T_{inst} \leq$ [Nm]	50	50	50	50	50	80	80	80	100	120	120
Diameter of clearance hole in the fixture												
Pre-setting installation	$d_f \leq$ [mm]	18	18	18	18	18	22	24 (22)	24 (22)	26	26	26
Through-setting installation	$d_f \leq$ [mm]	20	20	20	20	20	24	26	26	28	28	28

**Pre-setting installation**

**Through-setting installation**

size  
M8 to M16,  
M20 LG, M24 LG

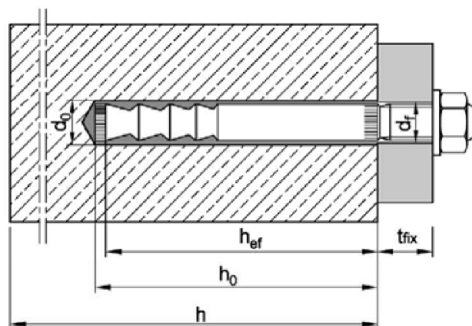

size  
M20 + M24

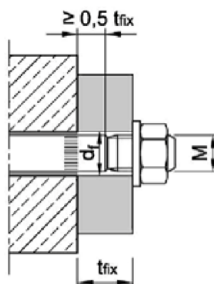

size  
M10 to M16,  
M20 LG, M24 LG

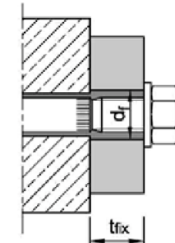

size  
M20 + M24

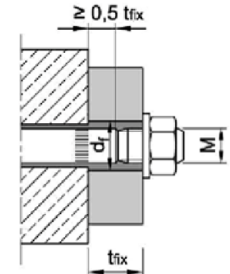

The annular gap in the clearance hole in the fixture has to be filled completely by excess mortar!

**Injection System VMZ**

**Intended use**  
Installation parameters **VMZ-A**

**Annex B4**

**Table B5: Minimum spacing and edge distance, VMZ-A M8 – M12**

Anchor size		VMZ-A	40 M8	50 M8	60 M10	75 M10	75 M12	70 M12	80 M12	95 M12	100 M12	110 M12	125 M12
Minimum thickness of concrete	$h_{min}$	[mm]	80	80	100	110 100 <sup>1)</sup>	110	110	110	130 125 <sup>1)</sup>	130	140	160
<b>Cracked concrete</b>													
Minimum spacing	$s_{min}$	[mm]	40	40	40	40	50	55	40	40	50	50	50
Minimum edge distance	$c_{min}$	[mm]	40	40	40	40	50	55	50	50	50	50	50
<b>Uncracked concrete</b>													
Minimum spacing	$s_{min}$	[mm]	40	40	50	50	50	55	55	55	80 <sup>2)</sup>	80 <sup>2)</sup>	80 <sup>2)</sup>
Minimum edge distance	$c_{min}$	[mm]	40	40	50	50	50	55	55	55	55 <sup>2)</sup>	55 <sup>2)</sup>	55 <sup>2)</sup>

**Table B6: Minimum spacing and edge distance, VMZ-A M16 – M24**

Anchor size		VMZ-A	90 M16	105 M16	125 M16	145 M16	160 M16	115 M20	170 M20 (LG)	190 M20 (LG)	170 M24 (LG)	200 M24 (LG)	225 M24 (LG)
Minimum thickness of concrete	$h_{min}$	[mm]	130	150	170 160 <sup>1)</sup>	190 180 <sup>1)</sup>	205 200 <sup>1)</sup>	160	230 220 <sup>1)</sup>	250 240 <sup>1)</sup>	230 220 <sup>1)</sup>	270 260 <sup>1)</sup>	300 290 <sup>1)</sup>
<b>Cracked concrete</b>													
Minimum spacing	$s_{min}$	[mm]	50	50	60	60	60	80	80	80	80	80	80
Minimum edge distance	$c_{min}$	[mm]	50	50	60	60	60	80	80	80	80	80	80
<b>Uncracked concrete</b>													
Minimum spacing	$s_{min}$	[mm]	50	60	60	60	60	80	80	80	80	105	105
Minimum edge distance	$c_{min}$	[mm]	50	60	60	60	60	80	80	80	80	105	105

<sup>1)</sup> The reverse of the concrete member must not be damaged after drilling and must be filled with high-strength mortar if drilled through.

<sup>2)</sup> For an edge distance  $c \geq 80$  mm a minimum spacing  $s_{min} = 55$  mm is applicable

**Injection System VMZ**

**Intended use**  
Minimum spacing and edge distance, VMZ-A

**Annex B5**

**Table B7: Installation parameters VMZ-IG**

Anchor size		VMZ-IG	40 M6	50 M6	60 M8	75 M8	70 M10	80 M10	90 M12	105 M12	125 M12	115 M16	170 M16	170 M20
Effective anchorage depth	$h_{ef}$	[mm]	40	50	60	75	70	80	90	105	125	115	170	170
Nominal diameter of drill hole	$d_0$	[mm]	10	10	12	12	14	14	18	18	18	22	24	26
Depth of drill hole	$h_0 \geq$	[mm]	42	55	65	80	80	85	98	113	133	120	180	185
Diameter of cleaning brush	$D \geq$	[mm]	10,8	10,8	13,0	13,0	15,0	15,0	19,0	19,0	19,0	23,0	25,0	27,0
Installation torque	$T_{inst} \leq$	[Nm]	8	8	10	10	15	15	25	25	25	50	50	80
Diameter of clearance hole in the fixture	$d_f \leq$	[mm]	7	7	9	9	12	12	14	14	14	18	18	22
Available thread length	$L_{th}$	[mm]	12	15	16	19	20	23	24	27	30	32	32	40
Minimum screw-in depth	$L_{sdmin}$	[mm]	7	7	9	9	12	12	14	14	14	18	18	22
Minimum thickness of concrete	$h_{min}$	[mm]	80	80	100	110	110	110	130	150	170 160 <sup>1)</sup>	160	230 220 <sup>1)</sup>	230 220 <sup>1)</sup>
<b>Cracked concrete</b>														
Minimum spacing	$s_{min}$	[mm]	40	40	40	40	55	40	50	50	60	80	80	80
Minimum edge distance	$c_{min}$	[mm]	40	40	40	40	55	50	50	50	60	80	80	80
<b>Uncracked concrete</b>														
Minimum spacing	$s_{min}$	[mm]	40	40	50	50	55	55	50	60	60	80	80	80
Minimum edge distance	$c_{min}$	[mm]	40	40	50	50	55	55	50	60	60	80	80	80

<sup>1)</sup> The reverse of the concrete member must not be damaged after drilling.

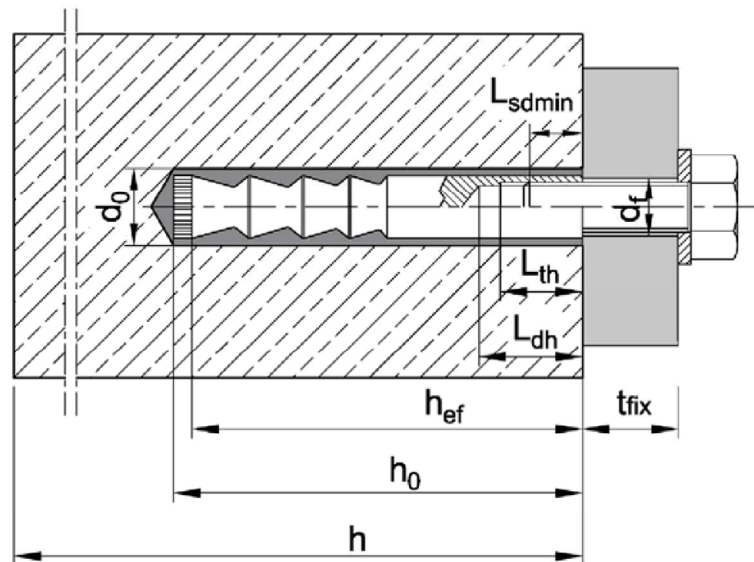

**Injection System VMZ**

**Intended use**  
Installation parameters **VMZ-IG**

**Annex B6**

# Installation instructions - Hammer drill bit

## Hammer drill bit

### Hole drilling

1		Use hammer drill or compressed air drill with drill bit and depth gauge. Drill perpendicular to concrete surface.
---	--	---

### Cleaning

#### Cleaning with compressed air (all sizes)

2a		Connect Air Blower to compressed air (min. 6 bar, oil-free). Open air valve and blow out drill hole along the entire depth with back and forth motion at least two times.
3a		Check diameter of cleaning brush. If the brush can be pushed into the drill hole without any resistance, it must be replaced. Chuck brush into drill machine. Turn on drill machine and brush drill hole back and forth along the entire drill hole depth at least two times while rotated by drill machine.
4a		Connect Air Blower to compressed air (min. 6 bar, oil-free). Open air valve and blow out drill hole along the entire depth with back and forth motion at least two times.

#### Manual cleaning (alternatively, up to drill hole diameter 18mm)

2b		Blow out drill hole from the bottom with Blow-out pump at least two times.
3b		Check diameter of cleaning brush. If the brush can be pushed into the drill hole without any resistance, it must be replaced. Chuck brush into drill machine. Turn on drill machine and brush drill hole back and forth along the entire drill hole depth at least two times while rotated by drill machine.
4b		Blow out drill hole from the bottom with Blow-out pump at least two times.

## Injection System VMZ

**Intended use**  
 Installation instructions  
 Hole drilling and cleaning (hammer drill bit)

**Annex B7**



## Installation instructions - Vacuum drill bit

### Vacuum drill bit

#### Hole drilling and cleaning

1

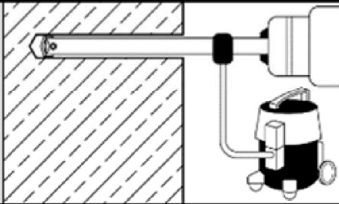

Drill hole perpendicular to concrete surface by using a vacuum drill bit (see Annex B1). The nominal underpressure of the vacuum cleaner must be at least 230 mbar / 23kPa.

**Pay attention to the function of the dust extraction system!**

Make sure the dust extraction is working properly throughout the whole drilling process.

**Additional cleaning is not necessary - continue with step 5!**

## Installation instructions - Diamond drilling

### Diamond drilling

#### Hole drilling

1

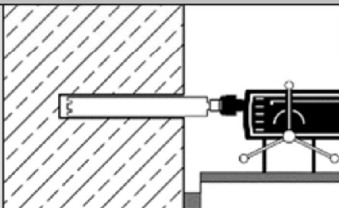

Use diamond drill with diamond drill bit and depth gauge. Drill perpendicular to concrete surface.

#### Cleaning

2

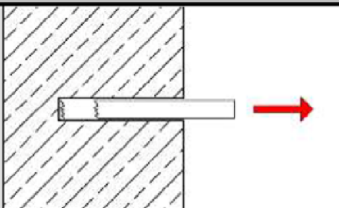

Remove drill core at least up to the nominal hole depth and check drill hole depth.

3

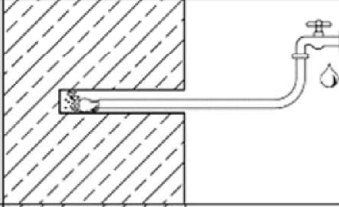

Flushing of drill hole:

Flush drill hole with water, starting from the bottom, until clear water gets out of the drill hole.

4

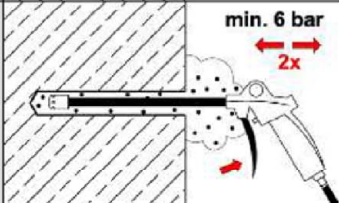

Connect Air Blower to compressed air (min. 6 bar, oil-free).

Open air valve and blow out drill hole along the entire depth with back and forth motion at least two times.

### Injection System VMZ

#### Intended use

Installation instructions

Hole drilling and cleaning (vacuum drill bit and diamond drill bit)

**Annex B8**

## Installation instructions - Continuation

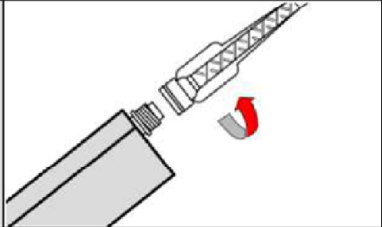
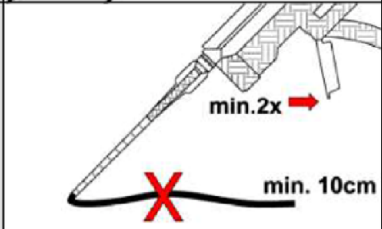
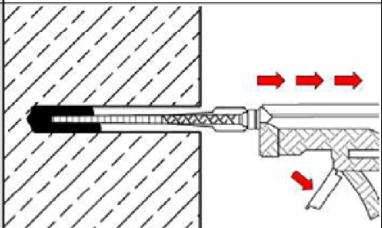
Injection		
5		<p>Check expiration date on cartridge. Never use when expired. Remove cap from cartridge. Attach the supplied static mixer to the cartridge. For every working interruption longer than the recommended working time (Table B1 or Table B2) as well as for a new cartridge always use a new static mixer. Never use static mixer without helix inside.</p>
6		<p>Insert cartridge in Dispenser. Before injecting discard mortar (at least 2 full strokes or a line of 10 cm) until it shows a consistent grey colour. Never use this mortar.</p>
7		<p>Prior to injection, check if static mixer reaches the bottom of the drill hole. If it does not reach the bottom, plug Mixer Extension onto static mixer in order to fill the drill hole properly. Fill hole with a sufficient quantity of injection mortar. Start from the bottom of the drill hole and work out to avoid trapping air pockets.</p>

### Injection System VMZ

Intended use  
Installation instructions  
Injection

Annex B9



## Installation instructions - Continuation

### Anchor rod VMZ-A

#### Inserting the anchor rod

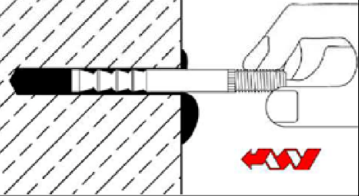
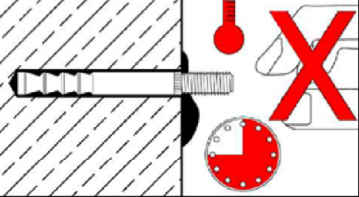
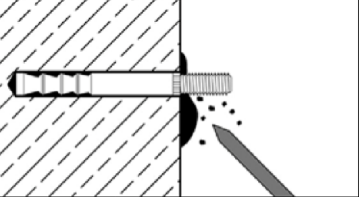
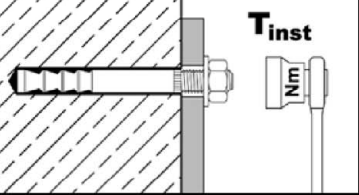
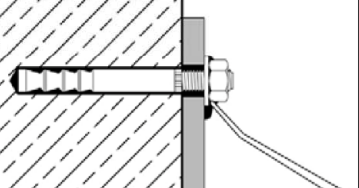
8		<p>Insert the anchor rod VMZ-A by hand, rotating slightly up to the full embedment depth as marked on the anchor rod. The anchor rod is properly set when excess mortar seeps from the hole (Pre-setting installation) or the annular gap in the clearance hole in the fixture is completely filled by excess mortar (Through-setting installation). If the hole is not completely filled, pull out anchor rod, let mortar cure, drill out hole and repeat entire cleaning process.</p>
9		<p>Follow minimum curing time shown in Table B1 or Table B2. During curing time, anchor rod must not be moved or loaded.</p>
10		<p>Remove excess mortar.</p>
11		<p>The fixture can be mounted after curing time. Apply installation torque <math>T_{inst}</math> according to Table B3 or Table B4 by using torque wrench.</p>
<h4>Filling annular gap</h4>		
Optional		<p>Annular gap between anchor rod and attachment may optionally be filled with mortar. Therefore, replace regular washer by washer with bore and plug on reducing adapter on static mixer. Annular gap is completely filled, when excess mortar seeps out.</p>

### Injection System VMZ

**Intended use**  
 Installation instructions  
 Installation Anchor rod VMZ-A

**Annex B10**

## Installation instructions – Stand-off Installation

### Stand-off installation with Anchor rod VMZ-A 75 M12

Requirement: Diameter of clearance hole in the fixture  $d_f \leq 14 \text{ mm}$

Work step 1-7 as illustrated in Annexes B7 – B9

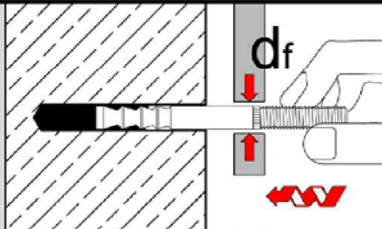
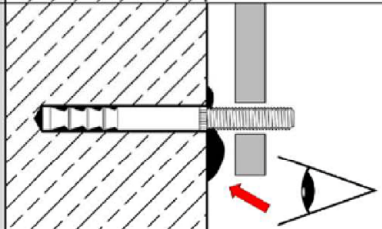
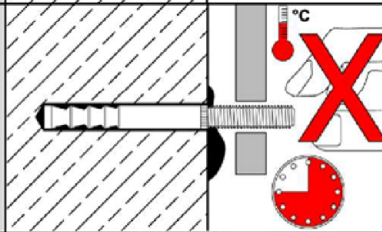
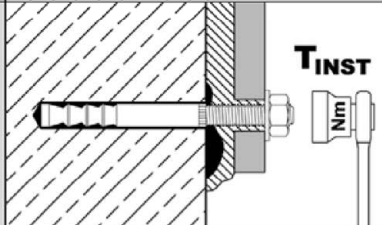
8		<p>Insert the anchor rod VMZ-A by hand, rotating slightly up to the full embedment depth.</p>
9		<p>Check if excess mortar seeps from the hole. If the hole is not completely filled, pull out anchor rod, let mortar cure, drill out hole and repeat the entire cleaning process.</p> <p><b>The annular gap in the fixture does not have to be filled.</b></p>
10		<p>During curing time according to Table B1 or Table B2 anchor rod must not be moved or loaded.</p>
11		<p>Washer and nut can be mounted after curing time and backfilling of anchor plate. Apply installation torque <math>T_{inst}</math> according to Table B3 by using torque wrench.</p>

Injection System VMZ

#### Intended use

Installation instructions VMZ-A 75 M12

Through-setting installation with clearance between concrete and anchor plate

Annex B11

## Installation instructions - Continuation

### Anchor rod VMZ-IG

#### Setting of anchor

Work step 1-7 as illustrated in Annexes B7 – B9

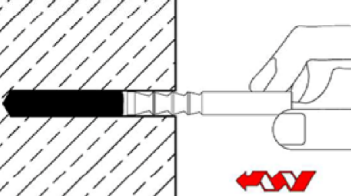
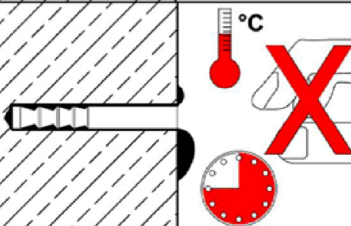
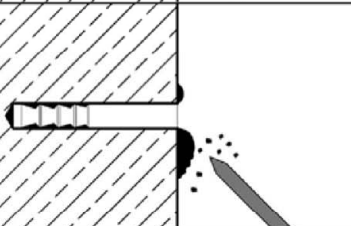
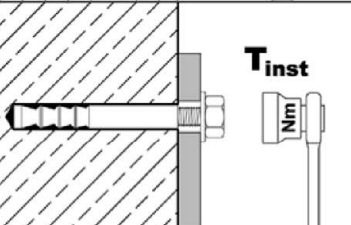
8		<p>Insert the anchor rod VMZ-IG by hand, rotating slightly up to about 1 mm below the concrete surface in the drill hole. The anchor rod is properly set when excess mortar seeps from the hole. If the hole is not completely filled, pull out anchor rod, let mortar cure, drill out hole and repeat the entire cleaning process.</p>
9		<p>Follow minimum curing time shown in Table B1 and Table B2. During curing time anchor rod must not be moved or loaded.</p>
10		<p>Remove excess mortar.</p>
11		<p>The fixture can be mounted after curing time. Apply installation torque <math>T_{inst}</math> according to Table B7 by using torque wrench.</p>

### Injection System VMZ

**Intended use**  
 Installation instructions  
 Anchor installation VMZ-IG

**Annex B12**

**Table C1: Characteristic values for concrete failure and splitting**

Anchor size		VMZ-A VMZ-IG	all sizes	
Concrete cone failure				
Factor for $k_1$	<u>uncracked</u> concrete	$k_{ucr,N}$	[-]	11,0
	<u>cracked</u> concrete	$k_{cr,N}$	[-]	7,7
Characteristic edge distance		$c_{cr,N}$	[mm]	$1,5 \cdot h_{ef}$
Characteristic spacing		$s_{cr,N}$	[mm]	$2 \cdot c_{cr,N}$
<b>Splitting</b>				
For each proof of splitting failure, $N_{Rk,sp}$ shall be calculated according to EN 1992-4:2018, equation (7.23). The higher value for $N_{Rk,sp}$ of case 1 and case 2 may be applied for the design.				
Case 1				
Characteristic resistance		$N^0_{Rk,sp}$	[kN]	see following tables
Characteristic edge distance		$c_{cr,sp}$	[mm]	$1,5 \cdot h_{ef}$
Characteristic spacing		$s_{cr,sp}$	[mm]	$2 \cdot c_{cr,sp}$
Case 2				
Characteristic resistance		$N^0_{Rk,sp}$	[kN]	min [ $N_{Rk,p}$ ; $N^0_{Rk,c}$ ]
Characteristic edge distance		$c_{cr,sp}$	[mm]	see following tables
Characteristic spacing		$s_{cr,sp}$	[mm]	$2 \cdot c_{cr,sp}$

**Injection System VMZ**

**Performance**  
Characteristic values for **concrete failure and splitting, VMZ-A and VMZ-IG**

**Annex C1**

**Table C2: Characteristic values for tension loads, VMZ-A M8 – M12, static and quasi-static action**

Anchor size		VMZ-A	40 M8	50 M8	60 M10	75 M10	75 M12	70 M12	80 M12	95 M12	100 M12	110 M12	125 M12	
Installation factor	$\gamma_{inst}$	[-]	1,0											
<b>Steel failure</b>														
Characteristic resistance	$N_{Rk,s}$	[kN]	15	18	25	35	49	54	57					
Partial factor	$\gamma_{Ms}$	[-]	1,5											
<b>Pull-out</b>														
Characteristic resistance (concrete C20/25)														
uncracked concrete	50°C / 80°C <sup>1)</sup>	$N_{Rk,p}$	[kN]	9	17,4	22,9	32,0	32,0	28,8	35,2	40	49,2	50	50
	72°C / 120°C <sup>1)</sup>		[kN]	6	9	16	16	16	16	25	25	30	30	30
cracked concrete	50°C / 80°C <sup>1)</sup>	$N_{Rk,p}$	[kN]	8,7	12,2	16,0	22,4	22,4	20,2	24,6	31,9	34,4	39,7	48,1
	72°C / 120°C <sup>1)</sup>		[kN]	5	7,5	12	12	12	16	20	20	30	30	30
<b>Splitting</b>														
Splitting for <b>standard thickness of concrete member</b>														
Standard thickness of concrete	$h_{min,1} \geq$	[mm]	100	120	150	150	140	160	190	200	220	250		
<b>Case 1</b>														
Characteristic resistance (concrete C20/25)	$N^0_{Rk,sp}$	[kN]	7,5	9	16	20	20	35,2	30	40				
<b>Case 2</b>														
Characteristic edge distance	$c_{cr,sp}$	[mm]	3 $h_{ef}$	2,5 $h_{ef}$	3,5 $h_{ef}$	3,5 $h_{ef}$	2,5 $h_{ef}$	1,5 $h_{ef}$	2,5 $h_{ef}$	2 $h_{ef}$	3 $h_{ef}$	2,5 $h_{ef}$		
Splitting for <b>minimum thickness of concrete member</b>														
Minimum thickness of concrete	$h_{min,2} \geq$	[mm]	80	100	110			125	130	140	160			
<b>Case 1</b>														
Characteristic resistance (concrete C20/25)	$N^0_{Rk,sp}$	[kN]	7,5	2)	16	16	20	25	25	30				
<b>Case 2</b>														
Characteristic edge distance	$c_{cr,sp}$	[mm]	3 $h_{ef}$	3,5 $h_{ef}$	3 $h_{ef}$	3,5 $h_{ef}$	3,5 $h_{ef}$	3 $h_{ef}$	3,5 $h_{ef}$	3 $h_{ef}$				
Increasing factor for $N_{Rk,p}$ and $N^0_{Rk,sp}$ (Case 1)	$\psi_c$	[-]	$\left(\frac{f_{ck}}{20}\right)^{0,5}$											
<b>Concrete cone failure</b>														
Effective anchorage depth	$h_{ef}$	[mm]	40	50	60	75	75	70	80	95	100	110	125	

<sup>1)</sup> Maximum long-term temperature / Maximum short-term temperature

<sup>2)</sup> No performance assessed

**Injection System VMZ**

**Performance**

Characteristic values for tension loads, VMZ-A M8 – M12, static and quasi-static action

**Annex C2**



**Table C3: Characteristic values for tension loads, VMZ-A M16 – M24, static and quasi-static action**

Anchor size		VMZ-A	90 M16	105 M16	125 M16	145 M16	160 M16	115 M20	170 M20 (LG)	190 M20 (LG)	170 M24 (LG)	200 M24 (LG)	225 M24 (LG)	
Installation factor	$\gamma_{inst}$	[-]	1,0											
<b>Steel failure</b>														
Characteristic tension resistance $N_{Rk,s}$	Steel, zinc plated	[kN]	88	95	111		97	96	188		222			
	A4, HCR	[kN]	88	95	111		97	114	165		194			
Partial factor	$\gamma_{Ms}$	[-]	1,5					1,68	1,5		1,5			
<b>Pull-out</b>														
Characteristic resistance (concrete C20/25)														
uncracked concrete	50°C/80°C <sup>1)</sup> 72°C/120°C <sup>1)</sup>	$N_{Rk,p}$	[kN]	42,0	52,9	68,8	75	90	60,7	109,0	128,8	109,0	139,1	166,0
			[kN]	25	35	50		53	40	75		95		
cracked concrete	50°C/80°C <sup>1)</sup> 72°C/120°C <sup>1)</sup>	$N_{Rk,p}$	[kN]	29,4	37,1	48,1	60,1	69,7	42,5	76,3	90,2	76,3	97,4	116,2
			[kN]	25	30	50		51	30	60		75		
<b>Splitting</b>														
Splitting for <b>standard thickness of concrete</b>														
Standard thickness of concrete	$h_{min,1} \geq$	[mm]	180	200	250	290	320	230	340	380	340	400	450	
<b>Case 1</b>														
Characteristic resistance (concrete C20/25)	$N^0_{Rk,sp}$	[kN]	40	50		60	80	60,7	109	115	109	139,1	140	
<b>Case 2</b>														
Characteristic edge distance	$c_{cr,sp}$	[mm]	2 $h_{ef}$					1,5 $h_{ef}$		2 $h_{ef}$	1,5 $h_{ef}$		1,8 $h_{ef}$	
Splitting for <b>minimum thickness of concrete</b>														
Minimum thickness of concrete	$h_{min,2} \geq$	[mm]	130	150	160	180	200	160	220	240	220	260	290	
<b>Case 1</b>														
Characteristic resistance (concrete C20/25)	$N^0_{Rk,sp}$	[kN]	35	50	40	50	71	2)	75		109	115		
<b>Case 2</b>														
Characteristic edge distance	$c_{cr,sp}$	[mm]	2,5 $h_{ef}$		3 $h_{ef}$	2,5 $h_{ef}$		2,5 $h_{ef}$	2,6 $h_{ef}$	2,2 $h_{ef}$	2,6 $h_{ef}$	2,2 $h_{ef}$		
Increasing factor for $N_{Rk,p}$ and $N^0_{Rk,sp}$ (Case 1)	$\psi_c$	[-]	$\left(\frac{f_{ck}}{20}\right)^{0,5}$											
<b>Concrete cone failure</b>														
Effective anchorage depth	$h_{ef}$	[mm]	90	105	125	145	160	115	170	190	170	200	225	

<sup>1)</sup> Maximum long-term temperature / Maximum short-term temperature

<sup>2)</sup> No performance assessed

### Injection System VMZ

#### Performance

Characteristic values for tension loads, VMZ-A M16 – M24, static and quasi-static action

**Annex C3**



**Table C4: Characteristic values for shear load, VMZ-A M8 – M12, static and quasi-static action**

Anchor size		VMZ-A	40 M8	50 M8	60 M10	75 M10	75 M12	70 M12	80 M12	95 M12	100 M12	110 M12	125 M12
Installation factor	$\gamma_{inst}$	[-]	1,0										
<b>Steel failure without lever arm</b>													
Characteristic resistance $V^{0}_{Rk,s}$	Steel, zinc plated	[kN]	14	21	34								
	A4, HCR	[kN]	15	23	34								
Partial factor	$\gamma_{Ms}$	[-]	1,25										
Factor for ductility	$k_7$	[-]	1,0										
<b>Steel failure with lever arm</b>													
Characteristic bending resistance $M^{0}_{Rk,s}$	Steel, zinc plated	[Nm]	30	60	105								
	A4, HCR	[Nm]	30	60	105								
Partial factor	$\gamma_{Ms}$	[-]	1,25										
<b>Concrete pry-out failure</b>													
Pry-out factor	$k_8$	[-]	2										
<b>Concrete edge failure</b>													
Effective length of anchor in shear load	$l_f$	[mm]	40	50	60	75	75	70	80	95	100	110	125
Diameter of anchor	$d_{nom}$	[mm]	10	12	12	14							

**Injection System VMZ**

**Performance**  
 Characteristic values for **shear load, VMZ-A M8 – M12,**  
 static and quasi-static action

**Annex C4**

**Table C5: Characteristic values for shear load, VMZ-A M16 – M24, static or quasi-static action**

Anchor size		VMZ-A	90 M16	105 M16	125 M16	145 M16	160 M16	115 M20	170 M20 (LG)	190 M20 (LG)	170 M24 (LG)	200 M24 (LG)	225 M24 (LG)
Installation factor	$\gamma_{inst}$	[-]	1,0										
<b>Steel failure without lever arm</b>													
Characteristic resistance $V_{Rk,s}^0$	Steel, zinc plated	[kN]	63				70	149 <sup>1)</sup> (98)		178 <sup>1)</sup> (141)			
	A4, HCR	[kN]	63				86	131 <sup>1)</sup> (86)		156 <sup>1)</sup> (123)			
Partial factor	$\gamma_{Ms}$	[-]	1,25				1,4	1,25		1,25			
Factor for ductility	$k_7$	[-]	1,0										
<b>Steel failure with lever arm</b>													
Characteristic bending resistance $M_{Rk,s}^0$	Steel, zinc plated	[Nm]	266				392	519		896			
	A4, HCR	[Nm]	266				454		784				
Partial factor	$\gamma_{Ms}$	[-]	1,25				1,4	1,25		1,25			
<b>Concrete pry-out failure</b>													
Pry-out factor	$k_8$	[-]	2,0										
<b>Concrete edge failure</b>													
Effective length of anchor in shear load	$l_f$	[mm]	90	105	125	145	160	115	170	190	170	200	225
Diameter of anchor	$d_{nom}$	[mm]	18				22	24		26			

<sup>1)</sup> This value may only be applied if  $l_t \geq 0,5 t_{fix}$

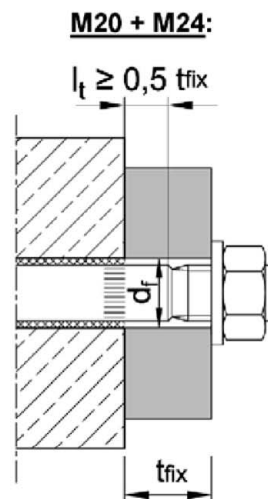

**Injection System VMZ**

**Performance**

Characteristic values for shear load, VMZ-A M16 – M24, static and quasi-static action

**Annex C5**

**Table C6: Characteristic values for seismic action,  
VMZ-A M10 – M12 performance category C1 and C2**

Anchor size		VMZ-A	60 M10	75 M10	75 M12	70 M12	80 M12	95 M12	100 M12	110 M12	125 M12
<b>Tension loads</b>											
Installation factor		$\gamma_{inst}$	[-]		1,0						
<b>Steel failure, steel zinc plated, stainless steel A4, HCR</b>											
Characteristic resistance		$N_{Rk,s,C1}$ $N_{Rk,s,C2}$	[kN]		25	35	49	54	57		
Partial factor		$\gamma_{Ms}$	[-]		1,5						
<b>Pull-out (concrete C20/25 to C50/60)</b>											
Characteristic resistance		$N_{Rk,p,C1}$	50°C / 80°C <sup>1)</sup>	[kN]	14,5	14,5	30,6	36,0	41,5	42,8	
			72°C / 120°C <sup>1)</sup>	[kN]	10,9	10,9	20,0	30,0			
		$N_{Rk,p,C2}$	50°C / 80°C <sup>1)</sup>	[kN]	7,4	7,4	8,7	17,6			
			72°C / 120°C <sup>1)</sup>	[kN]	5,1	5,1	6,5	12,3			

<b>Shear loads</b>											
<b>Steel failure without lever arm, steel zinc plated</b>											
Characteristic resistance		$V_{Rk,s,C1}$	[kN]	11,8	27,2						
		$V_{Rk,s,C2}$	[kN]	12,6	27,2						
Partial factor		$\gamma_{Ms}$	[-]		1,25						
<b>Steel failure without lever arm, stainless steel A4, HCR</b>											
Characteristic resistance		$V_{Rk,s,C1}$	[kN]	12,9	27,2						
		$V_{Rk,s,C2}$	[kN]	13,8	27,2						
Partial factor		$\gamma_{Ms}$	[-]		1,25						
Factor for anchorages with		filled annular gap	$\alpha_{gap}$	[-]		1,0					
		unfilled annular gap	$\alpha_{gap}$	[-]		0,5					

<sup>1)</sup> Maximum long-term temperature / Maximum short-term temperature

<b>Injection System VMZ</b>								<b>Annex C6</b>			
<b>Performance</b> Characteristic values for seismic action, VMZ-A M10 – M12, performance category C1 and C2											

**Table C7: Characteristic values for seismic action,  
VMZ-A M16 – M24, performance category C1 and C2**

Anchor size		VMZ-A	90 M16	105 M16	125 M16	145 M16	160 M16	115 M20	170 M20 (LG)	190 M20 (LG)	170 M24 (LG)	200 M24 (LG)	225 M24 (LG)
<b>Tension loads</b>													
Installation factor		$\gamma_{inst}$	[-]		1,0								
<b>Steel failure, steel zinc plated</b>													
Characteristic resistance		$N_{Rk,s,C1}$ $N_{Rk,s,C2}$	[kN]	88	95	111	97	96	188	222			
<b>Steel failure, stainless steel A4, HCR</b>													
Characteristic resistance		$N_{Rk,s,C1}$ $N_{Rk,s,C2}$	[kN]	88	95	111	97	114	165	194			
Partial factor		$\gamma_{Ms}$	[-]		1,5			1,68	1,5	1,5			
<b>Pull-out (concrete C20/25 to C50/60)</b>													
Charac- teristic resistance	$N_{Rk,p,C1}$	50°C / 80°C <sup>1)</sup>	[kN]	30,7	38,7	43,7		44,4	88,2	90,7			
		72°C / 120°C <sup>1)</sup>	[kN]	25,0	30,0	38,5		29,4	55,8	59,3			
	$N_{Rk,p,C2}$	50°C / 80°C <sup>1)</sup>	[kN]	16,3	22,1	26,1		30,9	59,7	59,7			
		72°C / 120°C <sup>1)</sup>	[kN]	10,5	14,4	19,5		16,2	44,4	44,4			
<b>Shear loads</b>													
<b>Steel failure without lever arm, steel zinc plated</b>													
Characteristic resistance		$V_{Rk,s,C1}$ $V_{Rk,s,C2}$	[kN]	39,1			39,1	82,3	107				
Partial factor		$\gamma_{Ms}$	[-]		1,25			1,4	1,25	1,25			
<b>Steel failure without lever arm, stainless steel A4, HCR</b>													
Characteristic resistance		$V_{Rk,s,C1}$ $V_{Rk,s,C2}$	[kN]	39,1			39,1	72,2	93				
Partial factor		$\gamma_{Ms}$	[-]		1,25			1,4	1,25	1,25			
Factor for anchorage with	filled annular gap	$\alpha_{gap}$	[-]		1,0								
	unfilled annular gap	$\alpha_{gap}$	[-]		0,5								

<sup>1)</sup> This value may only be applied if  $l_t \geq 0,5 t_{fix}$ . (see Annex C4)

**Injection System VMZ**

**Performance**

Characteristic values for **seismic action, VMZ-A M16 – M24,**  
performance category **C1 and C2**

**Annex C7**

**Table C8: Displacements under tension loads, VMZ-A M8 – M12**

Anchor size		VMZ-A	40 M8	50 M8	60 M10	75 M10	75 M12	70 M12	80 M12	95 M12	100 M12	110 M12	125 M12
Tension load in <b>cracked</b> concrete	N	[kN]	4,3	6,1	8,0	11,1	11,1	10,0	12,3	15,9	17,1	19,8	24,0
Displacement	$\delta_{N0}$	[mm]	0,5		0,5	0,6	0,6				0,7		
	$\delta_{N\infty}$	[mm]	1,3										
Tension load in <b>uncracked</b> concrete	N	[kN]	4,3	8,5	11,1	15,6	15,6	14,1	17,2	19,0	24,0	23,8	23,8
Displacement	$\delta_{N0}$	[mm]	0,2	0,4	0,4		0,4				0,6		
	$\delta_{N\infty}$	[mm]	1,3										
<b>Displacements under seismic tension loads C2</b>													
Displacements for DLS	$\delta_{N,C2(DLS)}$	[mm]	no performance assessed		1,0		1,0		1,3		1,1		
Displacements for ULS	$\delta_{N,C2(ULS)}$	[mm]	no performance assessed		3,0		3,0		3,9		3,0		

**Table C9: Displacements under tension loads, VMZ-A M16 – M24**

Anchor size		VMZ-A	90 M16	105 M16	125 M16	145 M16	160 M16	115 M20	170 M20 (LG)	190 M20 (LG)	170 M24 (LG)	200 M24 (LG)	225 M24 (LG)
Tension load in <b>cracked</b> concrete	N	[kN]	14,6	18,4	24,0	30,0	34,7	21,1	38,0	44,9	38,0	48,5	57,9
Displacement	$\delta_{N0}$	[mm]	0,7			0,8	1,2	0,7	0,8		0,8	0,9	
	$\delta_{N\infty}$	[mm]	1,3				1,6	1,1	1,3		1,3		
Tension load in <b>uncracked</b> concrete	N	[kN]	20,5	25,9	33,0	35,7	48,1	29,6	53,3	63,0	53,3	67,9	81,1
Displacement	$\delta_{N0}$	[mm]	0,6				0,8	0,5	0,6		0,6		
	$\delta_{N\infty}$	[mm]	1,3				1,6	1,1	1,3		1,3		
<b>Displacements under seismic tension loads C2</b>													
Displacements for DLS	$\delta_{N,C2(DLS)}$	[mm]	1,6		1,5			1,7	1,9		1,9		
Displacements for ULS	$\delta_{N,C2(ULS)}$	[mm]	3,7		4,4			4,0	4,5		4,5		

**Injection System VMZ**

**Performance**  
Displacements under tension loads, **VMZ-A**

**Annex C8**

**Table C10: Displacements under shear loads VMZ-A M8 – M12**

Anchor size		VMZ-A	40 M8	50 M8	60 M10	75 M10	75 M12	70 M12	80 M12	95 M12	100 M12	110 M12	125 M12
Shear load	V	[kN]	8,3		13,3		19,3						
Displacements	$\delta_{V0}$	[mm]	2,4	2,5	2,9		3,3						
	$\delta_{V\infty}$	[mm]	3,6	3,8	4,4		5,0						
<b>Displacements under seismic shear loads C2</b>													
Displacements for DLS	$\delta_{V,C2(DLS)}$	[mm]	no performance assessed		2,1		2,5						
Displacements for ULS	$\delta_{V,C2(ULS)}$	[mm]			3,7		5,1						

**Table C11: Displacements under shear loads VMZ-A M16 – M24**

Anchor size		VMZ-A	90 M16	105 M16	125 M16	145 M16	160 M16	115 M20	170 M20 (LG)	190 M20 (LG)	170 M24 (LG)	200 M24 (LG)	225 M24 (LG)	
Shear load	V	[kN]	36					44	75 (49)		89 (71)			
Displacements	$\delta_{V0}$	[mm]	3,8					3,0	4,3 (3,0)		4,6 (3,5)			
	$\delta_{V\infty}$	[mm]	5,7					4,5	6,5 (4,5)		6,9 (5,3)			
<b>Displacements under seismic shear loads C2</b>														
Displacements for DLS	$\delta_{V,C2(DLS)}$	[mm]	2,9					3,5		3,7				
Displacements for ULS	$\delta_{V,C2(ULS)}$	[mm]	6,8					9,3		9,3				

**Injection System VMZ**

**Performance**  
Displacements under shear loads, **VMZ-A**

**Annex C9**



**Table C12: Characteristic values for tension load, VMZ-IG**

Anchor size		VMZ-IG	40 M6	50 M6	60 M8	75 M8	70 M10	80 M10	90 M12	105 M12	125 M12	115 M16	170 M16	170 M20	
Installation factor	$\gamma_{inst}$	[-]	1,0												
<b>Steel failure</b>															
Characteristic resistance $N_{Rk,s}$	Steel, zinc plated	[kN]	15	16	19	29	35		67			52	125	108	
	A4, HCR	[kN]	11		19	21	33		47			65	88	94	
Partial factor	$\gamma_{Ms}$	[-]	1,5												
<b>Pull-out</b>															
Characteristic resistance (concrete C20/25)															
uncracked concrete	50°C / 80°C <sup>1)</sup>	$N_{Rk,p}$	[kN]	9	17,4	22,9	32	28,8	35,2	42	52,9	68,8	60,7	109	109
	72°C / 120°C <sup>1)</sup>		[kN]	6	9	16	16	16	25	25	35	50	40	75	95
cracked concrete	50°C / 80°C <sup>1)</sup>	$N_{Rk,p}$	[kN]	8,7	12,2	16	22,4	20,2	24,6	29,4	37,1	48,1	42,5	76,3	76,3
	72°C / 120°C <sup>1)</sup>		[kN]	5	7,5	12	12	16	20	20	30	50	30	60	75
<b>Splitting</b>															
<b>Splitting for standard thickness of concrete</b>															
Standard thickness of concrete	$h_{min,1} \geq$	[mm]	100	120	150	140	160	180	200	250	230	340	340		
<b>Case 1</b>															
Characteristic resistance (concrete C20/25)	$N^0_{Rk,sp}$	[kN]	7,5	9	16	20	20	35,2	40	50	50	60,7	109	109	
<b>Case 2</b>															
Characteristic edge distance	$c_{cr,sp}$	[mm]	3 $h_{ef}$		2,5 $h_{ef}$	3,5 $h_{ef}$	2,5 $h_{ef}$	1,5 $h_{ef}$	2 $h_{ef}$			1,5 $h_{ef}$	1,5 $h_{ef}$		
<b>Splitting for minimum thickness of concrete</b>															
Minimum thickness of concrete	$h_{min,2} \geq$	[mm]	80	100	110	110		130	150	160	160	220	220		
<b>Case 1</b>															
Characteristic resistance (concrete C20/25)	$N^0_{Rk,sp}$	[kN]	7,5	<sup>2)</sup>	16	20	25	35	50	40	<sup>2)</sup>	75	109		
<b>Case 2</b>															
Characteristic edge distance	$c_{cr,sp}$	[mm]	3 $h_{ef}$	3,5 $h_{ef}$	3 $h_{ef}$	3,5 $h_{ef}$	3,5 $h_{ef}$	3 $h_{ef}$	2,5 $h_{ef}$	2,5 $h_{ef}$	3 $h_{ef}$	2,5 $h_{ef}$	2,6 $h_{ef}$	2,6 $h_{ef}$	
Increasing factor for $N_{Rk,p}$ and $N^0_{Rk,sp}$ (case 1)	$\psi_c$	[-]	$\left(\frac{f_{ck}}{20}\right)^{0,5}$												
<b>Concrete cone failure</b>															
Effective anchorage depth	$h_{ef}$	[mm]	40	50	60	75	70	80	90	105	125	115	170	170	

<sup>1)</sup> Maximum long-term temperature / Maximum short-term temperature

<sup>2)</sup> No performance assessed

**Injection System VMZ**
**Performance**

 Characteristic values for tension loads, **VMZ-IG**
**Annex C10**

**Table C13: Characteristic values for shear load, VMZ-IG**

Anchor size		VMZ-IG	40 M6	50 M6	60 M8	75 M8	70 M10	80 M10	90 M12	105 M12	125 M12	115 M16	170 M16	170 M20
Installation factor	$\gamma_{inst}$	[-]	1,0											
<b>Steel failure without lever arm</b>														
Characteristic resistance $V^{0}_{RK,s}$	Steel, zinc plated	[kN]	8,0	9,5	15	18	34			26	63	54		
	A4, HCR	[kN]	5,5	9,5	10	16	24			32	44	47		
Partial factor	$\gamma_{Ms}$	[-]	1,25											
Ductility factor	$k_7$	[-]	1,0											
<b>Steel failure with lever arm</b>														
Characteristic bending resistance $M^{0}_{RK,s}$	Steel, zinc plated	[kN]	12	30	60	105			212	266	519			
	A4, HCR	[kN]	8,5	21	42	74			187	187	365			
Partial factor	$\gamma_{Ms}$	[-]	1,25											
<b>Concrete pry-out failure</b>														
Pry-out factor	$k_8$	[-]	2,0											
<b>Concrete edge failure</b>														
Effective length of anchor in shear load	$l_f$	[mm]	40	50	60	75	70	80	90	105	125	115	170	170
Outside diameter of anchor	$d_{nom}$	[mm]	10	12	14	18			22	24	26			

**Table C14: Displacements under tension loads, VMZ-IG**

Anchor size		VMZ-IG	40 M6	50 M6	60 M8	75 M8	70 M10	80 M10	90 M12	105 M12	125 M12	115 M16	170 M16	170 M20		
Tension load in <b>cracked</b> concrete	N	[kN]	4,3	6,1	8,0	11,1	10,0	12,3	14,6	18,4	24,0	21,1	38,0	38,0		
Displacement	$\delta_{N0}$	[mm]	0,5	0,5	0,6	0,6			0,7			0,7	0,8	0,8		
	$\delta_{N\infty}$	[mm]	1,3									1,1	1,3	1,3		
Tension load in <b>uncracked</b> concrete	N	[kN]	4,3	8,5	11,1	15,6	14,1	17,2	20,5	25,9	33,0	29,6	53,3	53,3		
Displacement	$\delta_{N0}$	[mm]	0,2	0,4	0,4			0,4			0,6			0,5	0,6	0,6
	$\delta_{N\infty}$	[mm]	1,3									1,1	1,3	1,3		

**Table C15: Displacements under shear loads, VMZ-IG**

Anchor size		VMZ-IG	40 M6	50 M6	60 M8	75 M8	70 M10	80 M10	90 M12	105 M12	125 M12	115 M16	170 M16	170 M20
Shear load	V	[kN]	4,6	5,4	8,4	10,1			19,3			14,8	35,8	30,7
Displacement	$\delta_{V0}$	[mm]	0,4	0,5	0,4	0,5			1,2			0,8	1,9	1,2
	$\delta_{V\infty}$	[mm]	0,7	0,8	0,7	0,8			1,9			1,2	2,8	1,9
Shear load	V	[kN]	3,2	5,4	5,9	9,3			13,5			18,5	25,2	26,9
Displacement	$\delta_{V0}$	[mm]	0,3	0,5	0,3	0,5			0,9			1,0	1,4	1,1
	$\delta_{V\infty}$	[mm]	0,4	0,7	0,5	0,7			1,4			1,5	2,1	1,6

**Injection System VMZ**

**Performance**  
Characteristic values for shear load VMZ-IG, Displacements VMZ-IG

**Annex C11**