

## VYHLÁSENIE O PARAMETROCH

DoP č.: **MKT-2.4-101\_sk**

- ❖ **Jedinečný identifikačný kód typu výrobku:** **Vstrekovací systém VMZ dynamic**
- ❖ **Zamýšľané použitie/použitia:** Upravené spojovacie prvky v betóne pri cyklickom zaťažení súvisiacom s únavou, viď príloha / Annex B
- ❖ **Výrobca:** MKT Metall-Kunststoff-Technik GmbH & Co.KG  
Auf dem Immel 2  
67685 Weilerbach
- ❖ **Systém(-y) posudzovania a overovania nemennosti parametrov:** 1
- ❖ **Európsky hodnotiaci dokument:** **EAD 330250-00-0601**  
Európske technické posúdenie: **ETA-17/0194, 29.11.2021**  
Orgán technického posudzovania: DIBt, Berlin  
Notifikovaný(-é) subjekt(-y): NB 2873 – Technische Universität Darmstadt

❖ **Deklarované parametre:**

Podstatné vlastnosti	Parametre
<b>Mechanická odolnosť a stabilita (BWR 1)</b>	
Charakteristická odolnosť pri ťahovom a priečnom zaťažení a posuny (statické a kvázistatické zaťaženia)	Príloha/Annex C4 – C6
Charakteristická odolnosť a posunutie pre kategórie seizmickej výkonnosti C1 + C2	Príloha/Annex C4 – C6
Charakteristická odolnosť proti únave pri cyklickom zaťažení zaťaženie v ťahu a šmyku	Príloha/Annex C1 – C3
<b>Hygiena, zdravie a životné prostredie (BWR 3)</b>	
Obsah, emisie a / alebo uvoľňovanie nebezpečných látok	Výkon nie je hodnotený

Uvedené parametre výrobku sú v zhode so súborom deklarováných parametrov. Toto vyhlásenie o parametroch sa v súlade s nariadením (EÚ) č. 305/2011 vydáva na výhradnú zodpovednosť uvedeného výrobcu.

Podpísal(-a) za a v mene výrobcu:



**Stefan Weustenhagen**  
(Generálny riaditeľ)  
**Weilerbach, 29.11.2021**

p.p.



**Dipl.-Ing. Detlef Bigalke**  
(Vedúci vývoja produktov)



Originál tohto vyhlásenia o vykonaní bol napísaný v nemčine. V prípade odchýlok v preklade platí nemecká verzia.

## Specifications of intended use

Injection System VMZ dynamic	100 M12	125 M16	170 M20
Fatigue cyclic loading		✓	
Static and quasi-static action		✓	
Seismic action (Category C1 + C2)		✓	
Cracked or uncracked concrete		✓	
Strength classes acc. to EN 206:2013		C20/25 to C50/60	
Reinforced or unreinforced normal weight concrete acc. to EN 206:2013		✓	
Temperature range I	-40 °C to +80 °C	maximum long term temperature +50 °C maximum short term temperature +80 °C	

**Use conditions (Environmental conditions):** according to ETA-04/0092

- Structures subject to dry internal conditions: all materials
- For all other conditions:  
Intended use of materials according to Annex A3, Table A1 corresponding to the corrosion resistance class CRC to EN 1993-1-4:2015

### Design:

- Anchorages are designed under the responsibility of an engineer experienced in anchorages and concrete work.
- Verifiable calculation notes and drawings are prepared taking account of the loads to be anchored. The position of the anchor is indicated on the design drawings (e.g. position of the anchor relative to reinforcement or to supports, etc.)
- Anchorages are designed according to:
  - EOTA TR 061:2020 (Design method I and II) or
  - EN 1992-4:2018

### Installation:

- Anchor shall only be used as a complete fastening unit delivered in series. Components of the anchor must not be replaced
- Anchor installation carried out by appropriately qualified personnel and under the supervision of the site manager
- Installation admissible in dry and wet concrete and in water-filled borehole
- Drill hole must be cleaned directly prior to installation of the anchor or the drill hole has to be protected against re-contamination in an appropriate way until dispensing the mortar in the drill hole.
- Water filled drill holes must not be polluted – otherwise the cleaning of the drill hole must be repeated.
- The anchor component installation temperature shall be at least +5 °C; during curing of the injection mortar the temperature of the concrete must not fall below -15 °C.
- It must be ensured that icing does not occur in the drill hole
- Installation direction D3: vertically downwards and upwards as well as horizontally
- Drilling by hammer drill bit, compressed air drill or vacuum drill bit
- The filling of the annular gap can be omitted if it is ensured that the anchor is only loaded in axial direction

## Injection System VMZ dynamic

Intended use  
Specifications

**Annex B1**

**Table B1: Installation parameters**

Anchor size / version			100 M12	100 M12 A4 100 M12 HCR	125 M16	125 M16 A4 125 M16 HCR	170 M20
Effective anchorage depth	$h_{ef} \geq$	[mm]	100		125		170
Nominal diameter of drill hole	$d_0 =$	[mm]	14		18		24
Depth of drill hole <sup>1)</sup>	$h_0 \geq$	[mm]	105		133		180
Diameter of cleaning brush	$D \geq$	[mm]	15,0		19,0		25,0
Installation torque	$T_{inst} =$	[Nm]	30		50		80
Diameter of clearance hole in the fixture	$d_f =$	[mm]	15		19		25
Fixture thickness <sup>2)</sup>	$t_{fix,min} \geq$	[mm]	12		16		20
	$t_{fix,max} \leq$	[mm]	200				
Overstand	$h_p =$	[mm]	$31 + t_{fix}$	$24 + t_{fix}$	$39 + t_{fix}$	$30 + t_{fix}$	$48 + t_{fix}$

<sup>1)</sup> If the present fixture thickness is lower than the maximum fixture thickness of the anchor, the depth of drill hole should be increased accordingly

<sup>2)</sup>  $t_{fix,min}$  may be replaced by  $t_{fix,min,red}$ , if, when determining the anchor under the highest load, the action  $\Delta V_{Ed}$  is smaller than the fatigue resistance in transverse direction

$$t_{fix,min,red} = \left( 0,5 + 0,5 \cdot \frac{\Delta V_{Ed}}{\Delta V_{Rd,s,E,n} * \psi_{FV}} \right) \cdot t_{fix,min}$$

**Pre-setting installation**

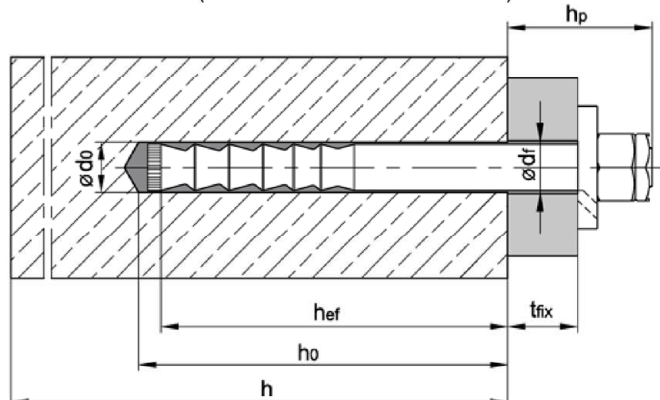

**Through-setting installation**

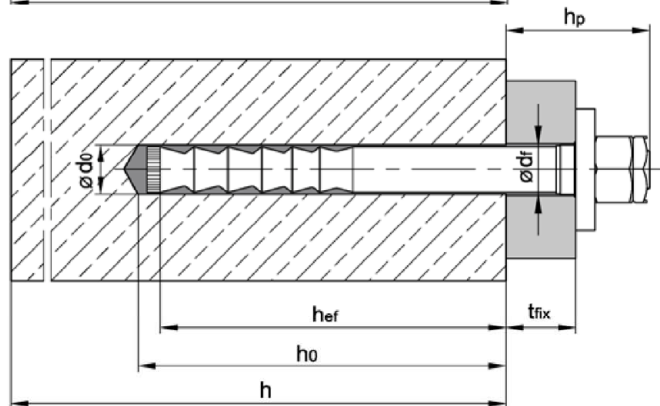

**Injection System VMZ dynamic**

Intended use  
Installation parameters

**Annex B2**

**Table B2: Minimum thickness of concrete and minimum spacing and edge distance – fatigue cyclic loading**

Anchor size			100 M12	125 M16	170 M20
Minimum thickness of concrete member	$h_{min}$	[mm]	130	170 160 <sup>1)</sup>	230 220 <sup>1)</sup>
<b>Cracked concrete</b>					
Minimum spacing	$s_{min}$	[mm]	50	60	80
Minimum edge distance <sup>2)</sup>	$c_{min}$	[mm]	70 (50)	80 (60)	110 (80)
<b>Uncracked concrete</b>					
Minimum spacing	$s_{min}$	[mm]	80	60	80
Minimum edge distance	$c_{min}$	[mm]	75	80	110

<sup>1)</sup> The remote face of the concrete member shall not be damaged after drilling and in case of through-drilling, it must be sealed with high strength mortar.

<sup>2)</sup> Values in brackets are valid if edge reinforcement  $d = 8$  mm is installed

**Table B3: Minimum thickness of concrete and minimum spacing and edge distance – static and quasi-static action and seismic action**

Anchor size			100 M12	125 M16	170 M20
Minimum thickness of concrete member	$h_{min}$	[mm]	130	170 160 <sup>1)</sup>	230 220 <sup>1)</sup>
<b>Cracked concrete</b>					
Minimum spacing	$s_{min}$	[mm]	50	60	80
Minimum edge distance	$c_{min}$	[mm]	50	60	80
<b>Uncracked concrete</b>					
Minimum spacing	$s_{min}$	[mm]	80 <sup>2)</sup>	60	80
Minimum edge distance	$c_{min}$	[mm]	55 <sup>2)</sup>	60	80

<sup>1)</sup> The remote face of the concrete member shall not be damaged after drilling and in case of through-drilling, it must be sealed with high strength mortar.

<sup>2)</sup> For edge distance  $c \geq 80$  mm, minimum spacing  $s_{min} = 55$  mm

**Injection System VMZ dynamic**

**Intended use**  
Minimum thickness of concrete, spacing and edge distances

**Annex B3**

**Table B4: Processing time and curing time, VMZ**

Temperature in the drill hole	Maximum processing time	Minimum curing time in dry concrete <sup>1)</sup>
- 15 °C to - 10 °C	45 min	7 d
- 9 °C to - 5 °C	45 min	10:30 h
- 4 °C to - 1 °C	45 min	6:00 h
0 °C to + 4 °C	20 min	3:00 h
+ 5 °C to + 9 °C	12 min	2:00 h
+ 10 °C to + 19 °C	6 min	1:20 h
+ 20 °C to + 29 °C	4 min	45 min
+ 30 °C to + 34 °C	2 min	25 min
+ 35 °C to + 39 °C	1,4 min	20 min
+ 40 °C	1,4 min	15 min

Cartridge temperature  $\geq 5^{\circ}\text{C}$

<sup>1)</sup> Curing time in wet concrete shall be doubled

**Table B5: Processing time and curing time, VMZ express**

Temperature in the drill hole	Maximum processing time	Minimum curing time in dry concrete <sup>1)</sup>
- 5 °C to - 1 °C	20 min	4:00 h
0 °C to + 4 °C	10 min	2:00 h
+ 5 °C to + 9 °C	6 min	1:00 h
+ 10 °C to + 19 °C	3 min	40 min
+ 20 °C to + 29 °C	1 min	20 min
+ 30 °C	1 min	10 min

Cartridge temperature  $\geq 5^{\circ}\text{C}$

<sup>1)</sup> Curing time in wet concrete shall be doubled

**Injection System VMZ dynamic**

**Intended use**  
Processing time and curing time

**Annex B4**

# Installation instructions – Through-setting installation

Hole drilling		
1		Drill hole perpendicular to concrete surface with hammer drill, compressed air drill or vacuum drill bit.
<b>Cleaning</b>		<b>Drill hole must be cleaned directly prior to installation of the anchor</b>
<b>all sizes</b>		<b>Cleaning with compressed air</b>
2a		Connect Air Blower to compressed air (min. 6 bar, oil-free). Open air valve and blow out drill hole along the entire depth with back and forth motion at least <b>two times</b> .
2b		Check diameter of Cleaning Brush. If brush can be pushed into the drill hole without any resistance, it must be replaced. Chuck brush into drill machine. Turn on drill machine. Brush drill hole back and forth along the entire drill hole depth at least <b>two times</b> while rotated by drill machine.
2c		Connect Air Blower to compressed air (min. 6 bar, oil-free). Open air valve and blow out drill hole along the entire depth with back and forth motion at least <b>two times</b> .
2	<b>M12 - M16</b>	<b>Manual cleaning</b> (alternative cleaning method)
2a		Blow out drill hole from the bottom using Blow-out Pump at least <b>two times</b> .
2b		Check diameter of Cleaning Brush. If brush can be pushed into the drill hole without any resistance, it must be replaced. Chuck brush into drill machine. Turn on drill machine. Brush drill hole back and forth along the entire drill hole depth at least <b>two times</b> while rotated by drill machine.
2c		Blow out drill hole from the bottom using Blow-out Pump at least <b>two times</b> .

<b>Injection System VMZ dynamic</b>		<b>Annex B5</b>
<b>Intended use</b>	Installation instructions – Through-setting installation	

## Installation instructions – Through-setting installation (continuation)

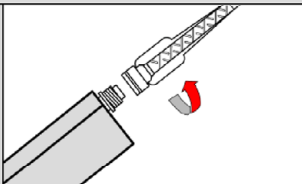
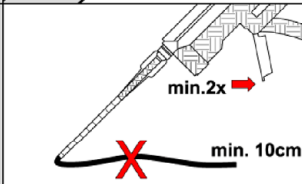
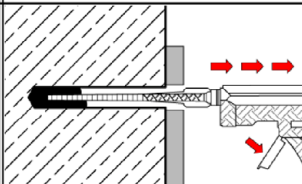
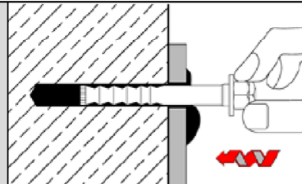
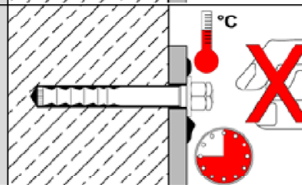
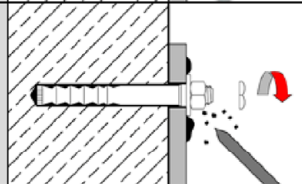
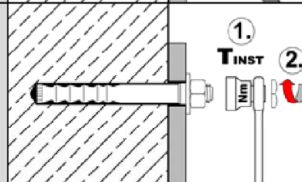
Injection		
3		Check minimum shelf-life on VMZ cartridge. Never use when expired. Remove cap from VMZ cartridge. Screw static mixer on cartridge. When using a new cartridge always use a new static mixer. Never use cartridge without static mixer and never use static mixer without helix inside.
4		Insert cartridge in dispenser. Before injecting discard mortar (at least 2 full strokes or a line of 10 cm) until it shows a consistent grey colour. Never use this mortar.
5		Prior to injection, check if static mixer reaches the bottom of the drill hole. If it does not reach the bottom, plug mixer extension onto static mixer, in order to properly fill the drill hole. Fill hole with a sufficient quantity of injection mortar. Start from the bottom of the drill hole and work out to avoid trapping air pockets.
Insertion of anchor rod		
6		Insert the pre-assembled anchor within processing time by hand, rotating slightly up to the full embedment depth, until the conical washer is in contact with the fixture. The anchor rod is properly set when the annular gap between anchor rod and fixture is completely filled. If no mortar is visible on the surface of the fixture, pull out the anchor rod immediately, let the mortar cure, drill out the hole and start again from step 2.
7		Follow minimum curing time shown in Table B4 and Table B5 as well as on cartridge label. During curing time anchor rod must not be moved or loaded.
8		Remove excess mortar after curing time. Remove locknut.
9		1. Apply installation torque $T_{inst}$ according to Table B1 by using torque wrench. 2. Screw on locknut until hand tight then tighten $\frac{1}{4}$ to $\frac{1}{2}$ turn using a screw wrench.

### Injection System VMZ dynamic

**Intended use**  
Installation instructions – Through-setting installation (continuation)

**Annex B6**

# Installation instructions – Pre-setting installation

## Hole drilling

1

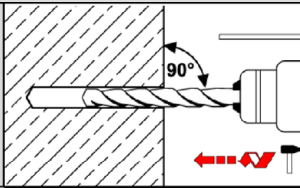

Drill perpendicular to concrete surface with hammer drill, vacuum drill or compressed air drill.

## Cleaning

**Drill hole must be cleaned directly prior to installation of the anchor**

all sizes

**Cleaning with compressed air**

2a

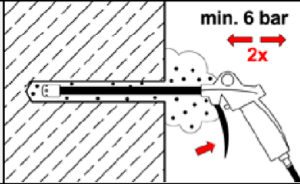

Connect Air Blower to compressed air (min. 6 bar, oil-free). Open air valve and blow out drill hole along the entire depth with back and forth motion at least **two times**.

2b

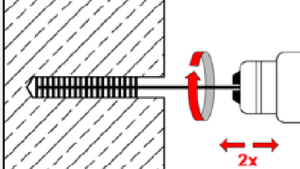

Check diameter of Cleaning Brush. If brush can be pushed into the drill hole without any resistance, it must be replaced. Chuck brush into drill machine. Turn on drill machine. Brush drill hole back and forth along the entire drill hole depth at least **two times** while rotated by drill machine.

2c

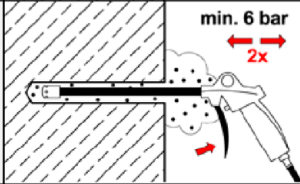

Connect Air Blower to compressed air (min. 6 bar, oil-free). Open air valve and blow out drill hole along the entire depth with back and forth motion at least **two times**.

2

M12 - M16

**Manual cleaning** (alternative cleaning method)

2a

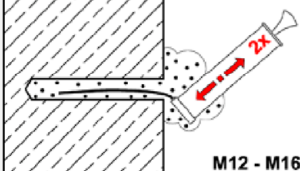

Blow out drill hole from the bottom using Blow-out Pump at least **two times**.

2b

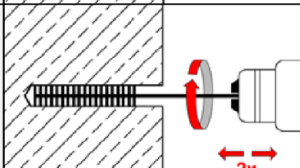

Check diameter of Cleaning Brush. If brush can be pushed into the drill hole without any resistance, it must be replaced. Chuck brush into drill machine. Turn on drill machine. Brush drill hole back and forth along the entire drill hole depth at least **two times** while rotated by drill machine.

2c



Blow out drill hole from the bottom using Blow-out Pump at least **two times**.

## Injection System VMZ dynamic

### Intended use

Installation instructions – Pre-setting installation

**Annex B7**

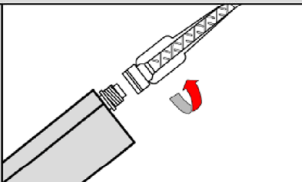
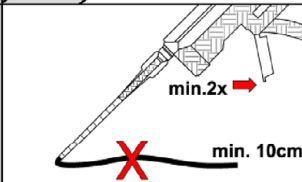
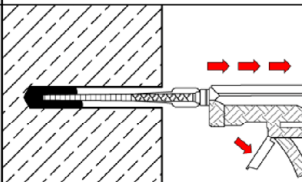
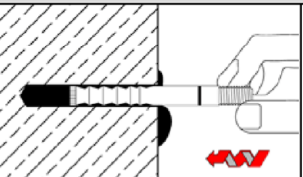
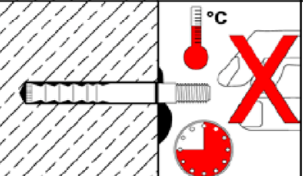
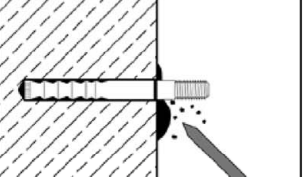
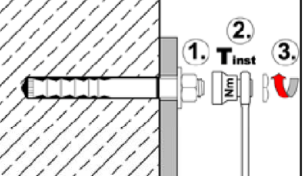
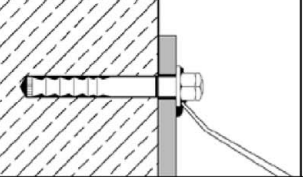

## Installation instructions – Pre-setting installation (continuation)

Injection		
3		Check minimum shelf-life on VMZ cartridge. Never use when expired. Remove cap from VMZ cartridge. Screw static mixer on cartridge. When using a new cartridge always use a new Mixer Nozzle. Never use cartridge without static mixer and never use static mixer without helix inside.
4		Insert cartridge in Dispenser. Before injecting discard mortar (at least 2 full strokes or a line of 10 cm) until it shows a consistent grey colour. Never use this mortar.
5		Prior to injection check if static mixer reaches the bottom of the drill hole. If it does not reach the bottom, plug mixer extension onto static mixer in order to properly fill the drill hole. Fill hole with a sufficient quantity of injection mortar. Start from the bottom of the drill hole and work out to avoid trapping air pockets.
Insertion of anchor rod		
6		Mark the embedment depth on the anchor rod. Insert the anchor rod by hand, rotating slightly up within processing time. The anchor rod is properly set when excess mortar seeps from the hole. If the hole is not completely filled, pull out anchor rod, let mortar cure, drill out hole and start again from step 2.
7		Follow minimum curing time shown in Annex B3 (Table B4 and Table B5) as well as on cartridge label. During curing time anchor rod must not be moved or loaded.
8		Remove excess mortar after curing time.
9		<ol style="list-style-type: none"> <li>1. Fixture, washer and nut (without centring ring) can be mounted.</li> <li>2. Apply installation torque <math>T_{inst}</math> according to Table B1 by using torque wrench.</li> <li>3. Screw on locknut hand-tight then tighten <math>\frac{1}{4}</math> to <math>\frac{1}{2}</math> turn using a screw wrench.</li> </ol>
10		Annular gap between anchor rod and fixture must be filled with injection mortar through the bore of the conical washer using the adapter plugged onto the static mixer. The annular gap is properly filled when excess mortar seeps out.

### Injection System VMZ dynamic

**Intended use**  
Installation instructions – Pre-setting installation (continuation)

**Annex B8**

## Installation instructions – Installation with clearance between concrete and anchor plate (if the fastener is only loaded in axial direction)

Work steps 1 - 5 as illustrated in Annex B4 und B5

### Insertion of anchor rod

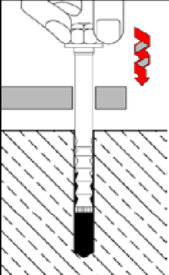
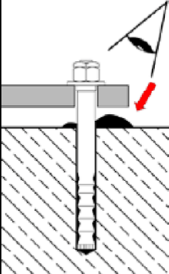
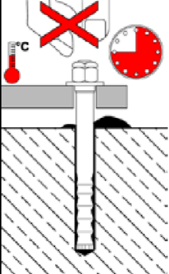
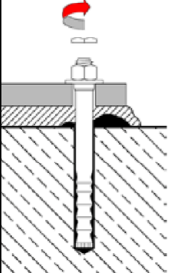
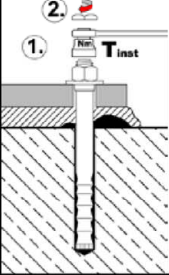
6		<p>Inserting the pre-assembled anchor within processing time by hand, rotating slightly until the conical washer lies against the fixture.</p>
7		<p>Check for excess mortar seeping out of the hole. If the hole is not completely filled, pull out anchor rod, let mortar cure, drill out hole and start again from step 2.</p> <p>The annular gap in the fixture does not have to be filled.</p>
8		<p>Follow minimum curing time shown in Annex B3 (Table B4 and Table B5) as well as on cartridge label. During curing time anchor rod must not be moved or loaded.</p>
9		<p>Remove locknut after curing time and backfilling of anchor plate.</p>
10		<ol style="list-style-type: none"> <li>1. Apply installation torque <math>T_{inst}</math> according to Annex B2 (Table B1) by using torque wrench.</li> <li>2. Screw on locknut hand-tight then tighten <math>\frac{1}{4}</math> to <math>\frac{1}{2}</math> turn using a screw wrench.</li> </ol>

### Injection System VMZ dynamic

#### Intended use

Installation instructions – Installation with clearance between concrete and anchor plate

**Annex B9**

**Table C1: Characteristic values of the fatigue resistance under tension load after n load cycles without static actions ( $F_{Eload} = 0$ ) design method I according to TR 061**

Anchor size / version		100 M12	100 M12 A4 100 M12 HCR	125 M16	125 M16 A4 125 M16 HCR	170 M20
<b>Steel failure</b>						
Characteristic resistance without static actions	[kN]	$\Delta N_{Rk,s,0,n}$				
Number of load cycles n	1	53,9	53,9	83,4	83,4	112,1
	$\leq 10^3$	48,3	52,6	78,8	72,5	92,7
	$\leq 3 \cdot 10^3$	45,9	50,9	77,1	68,2	89,9
	$\leq 10^4$	41,4	47,6	73,1	62,4	83,4
	$\leq 3 \cdot 10^4$	35,9	42,8	66,3	56,7	73,8
	$\leq 10^5$	29,1	36,3	55,8	50,5	60,9
	$\leq 3 \cdot 10^5$	24,2	30,1	45,5	45,7	50,7
	$\leq 10^6$	21,1	24,9	37,4	41,8	44,9
	$> 10^6$	20,1	21,2	34,0	37,3	43,5
Partial factor	$\gamma_{Ms,fat,n}$	[-] according to TR 061, Eq. (3)				
Exponent for combined loading	$\alpha_{sn}$	[-]	1,5	1,2	1,5	1,5
<b>Pull-out</b>						
Characteristic resistance without static actions	$\Delta N_{Rk,p,0,n}$	[kN]	$(\Delta N_{Rk,s,0,n} / \gamma_{Ms,fat,n}) \cdot \gamma_{Mp,fat}$			
Partial factor	$\gamma_{Mp,fat}$	[-]	1,5			
<b>Concrete failure</b>						
Characteristic resistance without static actions	$\Delta N_{Rk,c,0,n}$	[kN]	$\eta_{k,c,N,fat,n} \cdot N_{Rk,c}^{1)}$			
	$\Delta N_{Rk,sp,0,n}$	[kN]	$\eta_{k,c,N,fat,n} \cdot N_{Rk,sp}^{1)}$			
Reduction factor		[-]	$\eta_{k,c,N,fat,n}$			
Number of load cycles n	1		1,0			
	$\leq 10^3$		0,932			
	$\leq 3 \cdot 10^3$		0,893			
	$\leq 10^4$		0,841			
	$\leq 3 \cdot 10^4$		0,794			
	$\leq 10^5$		0,750			
	$\leq 3 \cdot 10^5$		0,722			
	$\leq 10^6$		0,704			
	$> 10^6$		0,693			
Effective anchorage depth	$h_{ef}$	[mm]	100		125	170
Partial factor	$\gamma_{Mc,fat}$	[-]	1,5			
Exponent for combined loading	$\alpha_c$	[-]	1,5			
Load-transfer factor for fastener groups	$\psi/FN$	[-]	0,79			

<sup>1)</sup> see table C4

**Injection System VMZ dynamic**

**Performance**

Characteristic fatigue resistance under **tension load, design method I** according to **TR 061**

**Annex C1**

**Table C2: Characteristic values of the fatigue resistance under shear load after n load cycles without static actions ( $F_{Elod} = 0$ ) design method I according to TR 061**

Anchor size / version			100 M12	100 M12 A4 100 M12 HCR	125 M16	125 M16 A4 125 M16 HCR	170 M20
<b>Steel failure</b>							
Characteristic resistance without static actions	[kN]	$\Delta V_{Rk,s,0,n}$					
Number of load cycles n	1	34,0			63,0		149,0
	$\leq 10^3$	27,6	31,3	54,0		113,5	
	$\leq 3 \cdot 10^3$	23,8	28,3	47,2		91,6	
	$\leq 10^4$	18,6	23,5	36,5		65,0	
	$\leq 3 \cdot 10^4$	14,1	18,1	26,2		43,9	
	$\leq 10^5$	10,5	12,8	18,4		29,0	
	$\leq 3 \cdot 10^5$	8,9	9,8	15,6		23,2	
	$\leq 10^6$	8,2	8,5	15,0		21,3	
	$> 10^6$	8,2			15,0		21,1
Partial factor	$\gamma_{Ms,fat,n}$	[-]	according TR 061, Eq. (3)				
Exponent for combined loading	$\alpha_{sn}$	[-]	1,5	1,2	1,5	1,5	1,5
<b>Concrete failure</b>							
Characteristic resistance without static actions	$\Delta V_{Rk,cp,0,n}$	[kN]	$\eta_{k,c,V,fat,n} \cdot V_{Rk,cp}^{1)}$				
	$\Delta V_{Rk,c,0,n}$	[kN]	$\eta_{k,c,V,fat,n} \cdot V_{Rk,c}^{1)}$				
Reduction factor		[-]	$\eta_{k,c,N,fat,n}$				
Number of load cycles n	1	1,0					
	$\leq 10^3$	0,799					
	$\leq 3 \cdot 10^3$	0,760					
	$\leq 10^4$	0,725					
	$\leq 3 \cdot 10^4$	0,700					
	$\leq 10^5$	0,680					
	$\leq 3 \cdot 10^5$	0,668					
	$\leq 10^6$	0,660					
	$> 10^6$	0,652					
Effective anchor length	$l_f$	[mm]	100		125		170
Outside diameter	$d_{nom}$	[mm]	14		18		24
Partial factor	$\gamma_{Mc,fat}$	[-]	1,5				
Exponent for combined loading	$\alpha_c$	[-]	1,5				
Load-transfer factor for fastener groups	$\psi_{FV}$	[-]	0,81				

<sup>1)</sup> see table C4

**Injection System VMZ dynamic**

**Performance**

Characteristic fatigue resistance under shear load for design method I according to TR 061

**Annex C2**

**Table C3: Characteristic fatigue limit resistance for design according to EN 1992-4:2018 and design method II according to TR 061**

Anchor size / version			100 M12	100 M12 A4 100 M12 HCR	125 M16	125 M16 A4 125 M16 HCR	170 M20
<b>Tension load</b>							
<b>Steel failure</b>							
Characteristic fatigue resistance	$\Delta N_{Rk,s,0,\infty}$	[kN]	20,1	21,2	34,0	37,3	43,5
Partial factor	$\gamma_{Ms,fat}$	[-]	1,35				
Load-transfer factor for fastener groups	$\psi_{FN}$	[-]	0,79				
<b>Pull-out</b>							
Characteristic fatigue resistance	$\Delta N_{Rk,p,0,\infty}$	[kN]	$(\Delta N_{Rk,s,0,\infty} / \gamma_{Ms,N,fat}) \cdot \gamma_{Mp,fat}$				
Partial factor	$\gamma_{Mp,fat}$	[-]	1,5				
<b>Concrete failure</b>							
Characteristic fatigue resistance	$\Delta N_{Rk,c,0,\infty}$	[kN]	0,693 $N_{Rk,c}$ <sup>1)</sup>				
	$\Delta N_{Rk,sp,0,\infty}$	[kN]	0,693 $N_{Rk,sp}$ <sup>1)</sup>				
Effective anchorage depth	$h_{ef}$	[mm]	100		125		170
Partial factor	$\gamma_{Mc,fat}$	[-]	1,5				
<b>Shear load</b>							
<b>Steel failure without lever arm</b>							
Characteristic fatigue resistance	$\Delta V_{Rk,s,0,\infty}$	[kN]	8,2		15,0		21,1
Partial factor	$\gamma_{Ms,fat}$	[-]	1,35				
Load-transfer factor for fastener groups	$\psi_{FV}$	[-]	0,81				
<b>Concrete pry-out failure</b>							
Characteristic fatigue resistance	$\Delta V_{Rk,cp,0,\infty}$	[kN]	0,652 $V_{Rk,cp}$ <sup>1)</sup>				
Partial factor	$\gamma_{Mc,fat}$	[-]	1,5				
<b>Concrete edge failure</b>							
Characteristic fatigue resistance	$\Delta V_{Rk,c,0,\infty}$	[kN]	0,652 $V_{Rk,c}$ <sup>1)</sup>				
Effective length of anchor	$l_f$	[mm]	100		125		170
Outside diameter of anchor	$d_{nom}$	[mm]	14		18		24
Partial factor	$\gamma_{Mc,fat}$	[-]	1,5				
Exponents for combined loading	$\alpha_s$	[-]	1,5	1,2	1,5		1,5
	$\alpha_{sn}$	[-]					
	$\alpha_c$	[-]	1,5				

**Injection System VMZ dynamic**

**Performance**

Characteristic **fatigue limit resistance** for design according to **EN 1992-4** and **design method II** according to **TR 061**

**Annex C3**

**Table C4: Characteristic values under tension load for static and quasi-static or seismic action**

Anchor size / version			100 M12 100 M12 A4 100 M12 HCR	125 M16 125 M16 A4 125 M16 HCR	170 M20	
<b>Steel failure</b>						
Characteristic resistance	$N_{Rk,s}$ $N_{Rk,s,C1}$ $N_{Rk,s,C2}$	[kN]	57	111	188	
Partial factor	$\gamma_{Ms}$	[-]	1,5			
<b>Pull-out failure</b>						
Characteristic resistance (C20/25)	uncracked concrete	$N_{Rk,p}$	[kN]	49,2	68,8	109
	cracked concrete	$N_{Rk,p}$	[kN]	34,4	48,1	76,3
	seismic C1	$N_{Rk,p,C1}$	[kN]	36,0	43,7	88,2
	seismic C2	$N_{Rk,p,C2}$	[kN]	17,6	26,1	59,7
<b>Concrete cone failure</b>						
Characteristic edge distance	$c_{cr,N}$	[mm]	$1,5 \cdot h_{ef}$			
Factor k1	uncracked concrete	$k_{ucr,N}$	[-]	11,0		
	cracked concrete	$k_{cr,N}$	[-]	7,7		
Effective anchorage depth	$h_{ef}$	[mm]	100	125	170	
<b>Splitting</b>						
For each proof of splitting failure, $N_{Rk,sp}$ shall be calculated according to EN 1992-4:2018, equation (7.23). The higher value for $N_{Rk,sp}$ of case 1 and case 2 may be applied for the design.						
<b>Standard thickness of concrete</b>		$h_{min,1} \geq$	[mm]	200	250	340
<b>Case 1</b>	Characteristic resistance (C20/25)	$N^0_{Rk,sp}$	[kN]	40	50	109
	Characteristic edge distance	$c_{cr,sp}$	[mm]	$1,5 \cdot h_{ef}$		
<b>Case 2</b>	Characteristic resistance	$N^0_{Rk,sp}$	[kN]	$\min [N_{Rk,p} ; N^0_{Rk,c}]$		
	Characteristic edge distance	$c_{cr,sp}$	[mm]	$2 \cdot h_{ef}$	$2 \cdot h_{ef}$	$1,5 \cdot h_{ef}$
<b>Minimum thickness of concrete</b>		$h_{min,2} \geq$	[mm]	130	160	220
<b>Case 1</b>	Characteristic resistance (C20/25)	$N^0_{Rk,sp}$	[kN]	30	40	75
	Characteristic edge distance	$c_{cr,sp}$	[mm]	$1,5 \cdot h_{ef}$		
<b>Case 2</b>	Characteristic resistance	$N^0_{Rk,sp}$	[kN]	$\min [N_{Rk,p} ; N^0_{Rk,c}]$		
	Characteristic edge distance	$c_{cr,sp}$	[mm]	$3 \cdot h_{ef}$	$3 \cdot h_{ef}$	$2,6 \cdot h_{ef}$
Increasing factor for $N_{Rk,p}$ and $N^0_{Rk,sp}$ (case 1)		$\psi_c$	[-]	$\left(\frac{f_{ck}}{20}\right)^{0,5}$		
Installation factor		$\gamma_{inst}$	[-]	1,0		

**Injection System VMZ dynamic**

**Performance**

Characteristic values for **tension load** under **static and quasi static** or **seismic action**

**Annex C4**

**Table C5: Characteristic values under shear load for static and quasi-static or seismic action**

Anchor size / version			100 M12 100 M12 A4 100 M12 HCR	125 M16 125 M16 A4 125 M16 HCR	170 M20
<b>Steel failure without lever arm</b>					
Characteristic resistance	$V_{Rk,s}^0$	[kN]	34	63	149
	$V_{Rk,s,C1}^0$	[kN]	27,2	39,1	82,3
	$V_{Rk,s,C2}^0$	[kN]	27,2	50,4	108,8
Partial factor	$\gamma_{Ms}$	[-]	1,25		
Ductility factor	$k_7$	[-]	1,0		
<b>Steel failure with lever arm</b>					
Characteristic bending resistance	$M_{Rk,s}^0$	[Nm]	105	266	519
Partial factor	$\gamma_{Ms}$	[-]	1,25		
<b>Concrete pry-out failure</b>					
Pry-out factor	$k_8$	[-]	2,0		
<b>Concrete edge failure</b>					
Effective length of anchor in shear load	$l_f$	[mm]	100	125	170
Diameter of anchor	$d_{nom}$	[mm]	14	18	24
Installation factor	$\gamma_{inst}$	[-]	1,0		
Factor for anchorages with filled annular gap	$\alpha_{gap}$	[-]	1,0		

**Injection System VMZ dynamic**

**Performance**  
Characteristic values under **shear load** for **static and quasi-static** or **seismic action**

**Annex C5**

**Table C6: Displacements under tension load for static and quasi-static or seismic action**

Anchor size / version			100 M12 100 M12 A4 100 M12 HCR	125 M16 125 M16 A4 125 M16 HCR	170 M20
Tension load in <b>cracked</b> concrete	N	[kN]	17,1	24	38
Displacements	$\delta_{N0}$	[mm]	0,6	0,7	0,8
	$\delta_{N\infty}$	[mm]	1,3	1,3	1,3
Tension load in <b>uncracked</b> concrete	N	[kN]	24	33	53,3
Displacements	$\delta_{N0}$	[mm]	0,4	0,6	0,6
	$\delta_{N\infty}$	[mm]	1,3	1,3	1,3
Displacements under <b>seismic tension loads C2</b>					
Displacements	$\delta_{N,C2(DLS)}$	[mm]	1,1	1,5	1,9
	$\delta_{N,C2(ULS)}$	[mm]	3,0	4,4	4,5

**Table C7: Displacements under shear load for static and quasi-static or seismic action**

Anchor size / version			100 M12 100 M12 A4 100 M12 HCR	125 M16 125 M16 A4 125 M16 HCR	170 M20
Shear load	V	[kN]	19,3	36	75
Displacements	$\delta_{V0}$	[mm]	3,3	3,8	4,3
	$\delta_{V\infty}$	[mm]	5,0	5,7	6,5
Displacements under <b>seismic shear loads C2</b>					
Displacements	$\delta_{V,C2(DLS)}$	[mm]	2,5	2,9	3,5
	$\delta_{V,C2(ULS)}$	[mm]	5,1	6,8	9,3

**Injection System VMZ dynamic**

**Performance**  
Displacements under **static and quasi-static** or **seismic action**

**Annex C6**